

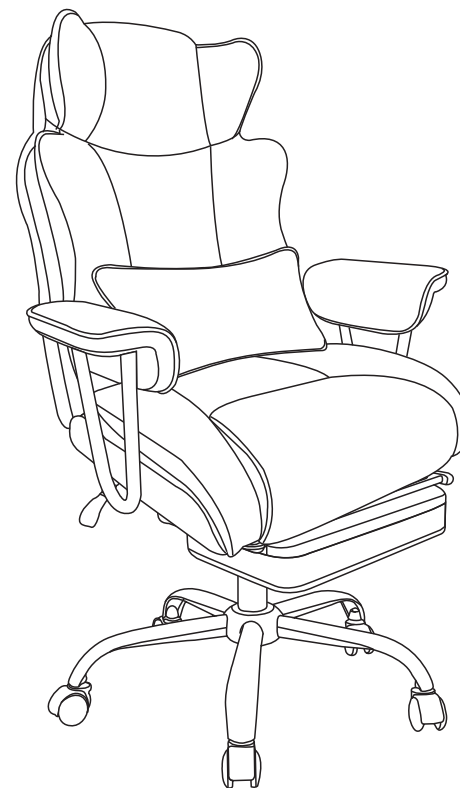









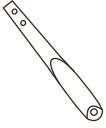
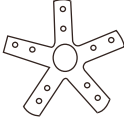
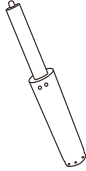
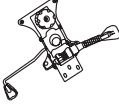

OFFICE CHAIR

ASSEMBLY INSTRUCTIONS

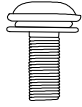

Assembly Instruction

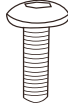
Parts List

A 	B 	C 	D 	E 
5PCS	5PCS	1PC	1PC	1PC
G 	H 	I 	J 	K  M6*20mm
1PC	1PC	1PC	2PCS	10PCS
L  M6*30mm	M  M8*25mm	N 	O  M6*25mm	P  M5*10mm 1PC
12PCS	3PCS	4PCS	4PCS	Q  1PC

Please note: Please check carefully if there are any missing parts before installation. If there are any missing parts, please place all the parts and take pictures then tell us the missing part number. We will reply you as soon as possible.

Assembly Instruction

Chair Assembly

Step 1

A*5

B*5

C*1

K*10

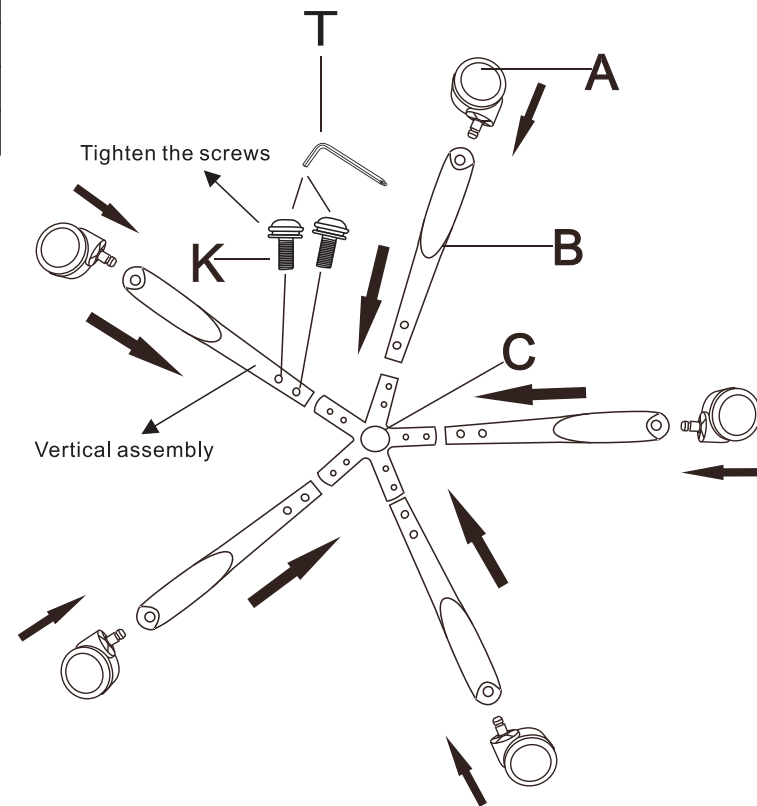

First, we need to prepare the connector (C), 5* metal feet (B), 5* universal wheels (A), 10*15mm screws (K) and a wrench (T). Then, according to the figure, insert the 5* metal feet into the connector, align the screw holes, install the screws and tighten them. Finally, a universal wheel is installed on the tail of each metal foot.

Assembly Instruction

Chair Assembly

Step 2

D*1

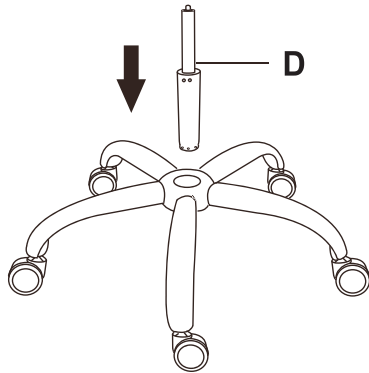

Step 3

E*1

H*1

O*4

M*3

P*1

I*1

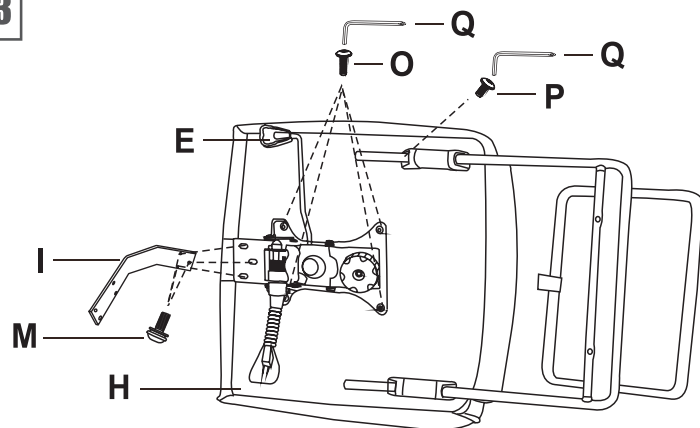

Fix the control unit to the base of the seat by screw (O) ,
Than pull-out the footrest pole and fix the foot rest by
screw (P) Screws tightened 80%.

THANK YOU

Register and Get the Full Benefit

It's our way of saying thank you.

Register your product to enjoy a number of benefits:

- (1) 2-year warranty extension
- (2) 24-7 quicker service and product support
- (3) Chance to test new products for free
- (4) Get specific discount on shop items

Assembly Instruction

Chair Assembly

Step 4

J*2

L*8

Put the steel plate (J) on the backrest, and fix it by screw (L)

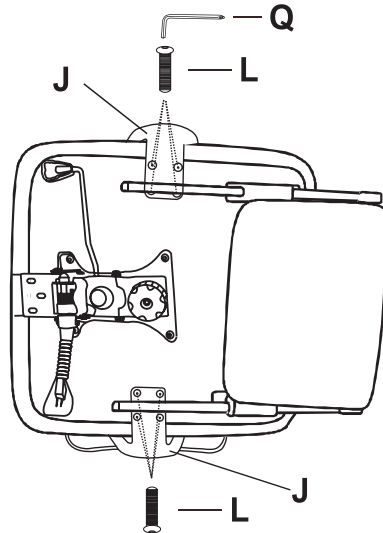

Step 5

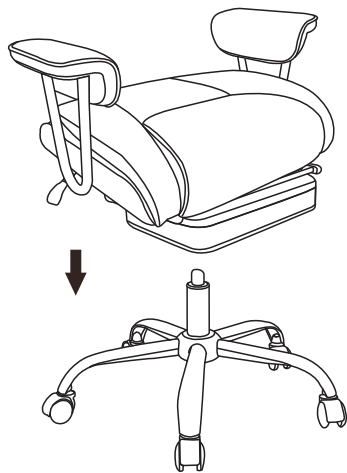

HEALTH CAUTION

- ⌘ If you have any concerns regarding your health, consult your doctor before using this product.
- ⌘ Individuals with pacemakers should not use this product.
- ⌘ If you experience pain in a muscle or joint for a prolonged period of time. Discontinue use and consult your doctor. Persistent pain could be a symptom of a more serious condition.

MAINTENANCE INSTRUCTIONS

TO STORE:

Place unit in its box or safe, dry, cool place. Avoid contact with sharp edges or pointed objects which might cut or puncture the fabric. Do not wrap power cord around the unit. Do not hang the unit by power cord.

TO CLEAN:

- ⌘ Insure the unit is unplugged from the power source, and allow to cool before cleaning.
- ⌘ Do not place in any liquid to clean. Clean fabric cover by wiping with a damp sponge, using a mild detergent or suds. Pat dry with clean, dry cloth.
- ⌘ Do not use abrasive cleaners, brushes, gasoline, kerosene, glass /furniturepolish, paint thinner or water hotter than 120°C to clean the unit.
- ⌘ To clean the unit, make sure the massager is unplugged. Allow the unit to cool and the wipe down with a damp clean cloth. Do not use any strong chemical cleaners.

Assembly Instruction

Chair Assembly

Step 6

G*1

I*1

N*4

L*4

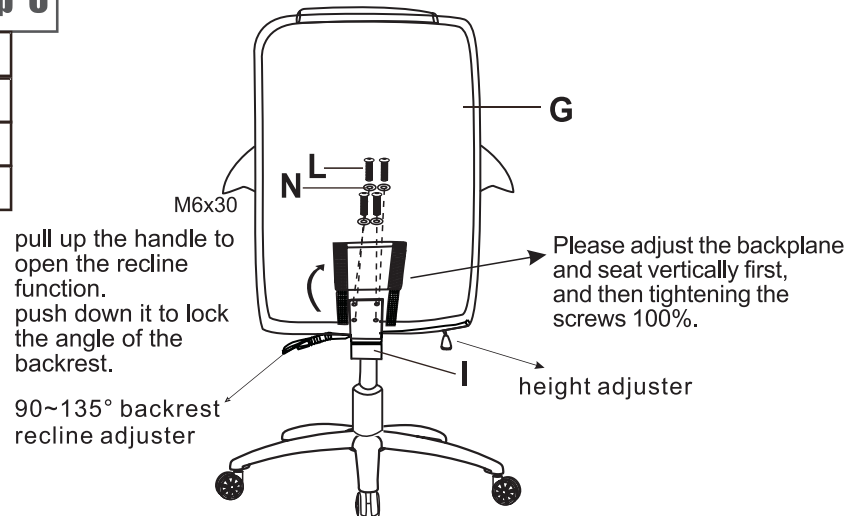

Step 7

Tension adjustment for the seatback. Loose the knob, recline rapidly. Tight the knob, recline not so fast. Warning: Keep the safety to adjust the knob in normal level, otherwise, it will be damaged the mechanism.

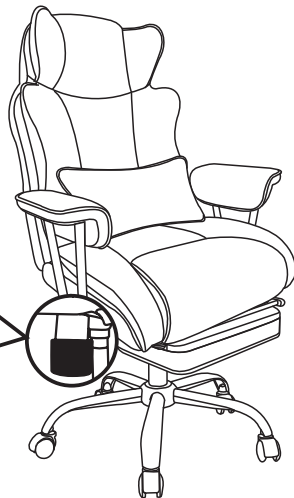

Assembly Instruction

Chair Assembly

