

agra link™

Tractor 3-Point Hitch Parts
Linkage Parts and Farm Accessories

Product Guide

50
YEARS
OF EXPERIENCE

Lynch Pins | Hitch Pins | Clevises
Drawbars | Roller Chain | Cow Bells
Trailer Jacks | Gate and Fence Accessories
Hubs/Sprockets/Pulleys

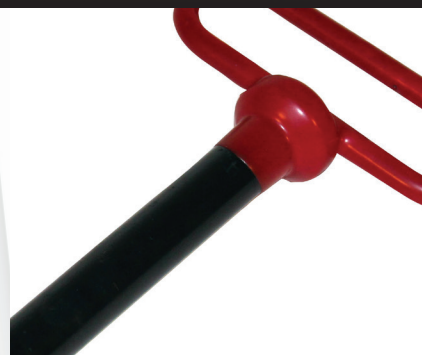
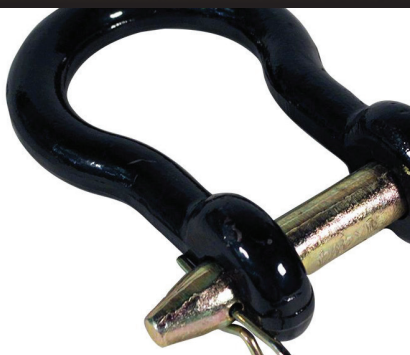

The Three Point Hitch

Top Link Connection

One end of the top link is fastened to the tractor at a bracket located behind the tractor seat. The other end of the top link is connected to the top bracket of the implement 'A' frame. Both connections are secured with a top link pin (similar to a clevis pin).

Top link pins are always unthreaded and are held in place by either a lynch pin, or in some cases, a large hairpin clip. (see fig. 3) Top link and top pins vary in length, but their respective ball socket holes and pin diameters are standardized by horsepower category. (see fig. 2)

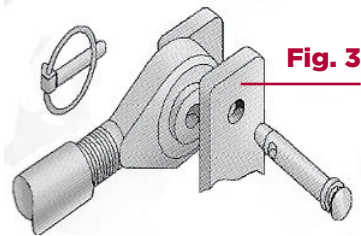

Lift Arm Connections

One end of each lift arm is secured to the tractor axle housing by a special OEM (original equipment manufacturer) mounting pin. The other end of the lift arm is connected to a lift arm pin, that has been fastened to the lower bracket of the implement's 'A' frame. Category 0, 1 and lighter category 2 implements use threaded lift arm pins that are bolted to the implement bracket. (see fig. 4) Heavier category 2 and most category 3 implements use special clevis pins, that are mounted through two brackets on the implement, thereby supporting both ends of the pin, similar to the top link connection. (see fig.3)

Most lift arm pins (other than clevis pin types) are threaded on the end that bolts to the implement bracket. The unthreaded end with the cross hole accommodates the ball socket of the lift arm. The lift arm is secured on the pin with a lynch pins or large hair pin clip. (see fig. 4)

Lift arms and lift arm pins vary in length, but their respective ball socket holes and pin diameters are standardized by horsepower category. (see fig. 2)

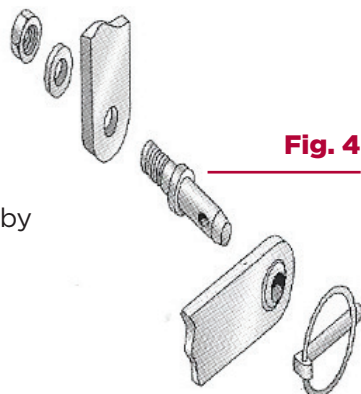

Background

Most tractors are equipped with a three point hitch for attaching implements to the tractor. It lets the operator raise implements when transporting them and provides height and tilt adjustments during use.

The three point hitch gets its name from the tractor's three hook up points: two lower lift arms and one top link. (see fig. 1) Special pins are used to fasten the implement at these three points. They are called top link pins at the top link connection and lift arm pins at the lift arm connections.

The diameters of the connection pins and corresponding ball sockets of the tractor's hitch points have been standardized by the American Society of Agricultural Engineers (ASAE) by horsepower category. (see fig. 2)

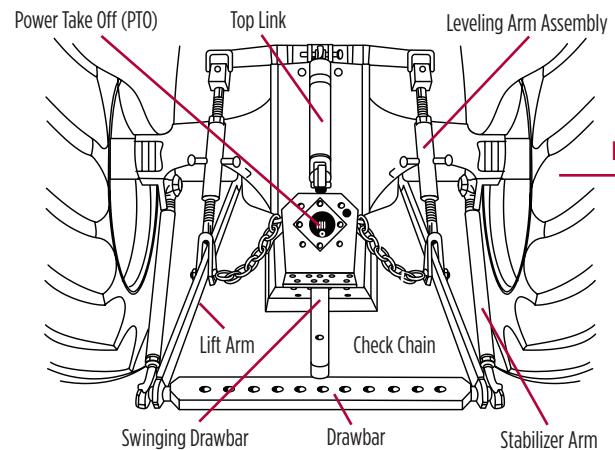

Category	Maximum Drawbar Horsepower	Top Link Pin Diameter	Lift Arm Pin Diameter	Lift Arm Spacing
0	up to 20	5/8"	5/8"	20"
1	up to 45	3/4"	7/8"	26"
2	40 to 100	1"	1-1/8"	26" or 32"
3	80 to 225	1-1/4"	1-7/16"	38"

Hitching Up Different Categories

Sometimes a tractor must be hitched to a different category implement. For example, a new category 2 tractor may be used to mow with an older category 1 rotary cutter. A category 1 top link pin should be used with a category 1 to 2 bushing to fit the tractor's category 2 top link ball socket. Agralink™ offers special lift arm pins with different diameter on each end. In this case, the category 1 pin could be replaced with a special lift arm pin, that has a 7/8" diameter threaded end to fit the category 1, 7/8" hole in the implement bracket and a category 2, 1-1/8" diameter unthreaded end to fit the tractor's category 2 lift arm ball socket. Agralink makes special pins and bushings in many varieties.

Table Of Contents

Packaging Key

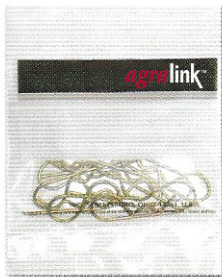

Type 'B'
Bagged Packaging

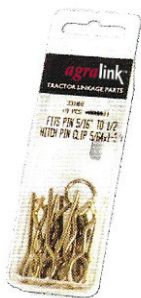

Type 'C'
Clamshell Packaging

Metric Conversion Chart

Centimeter = .393 inch
 Kilogram = 2.204 pounds
 Liter = 1.056 quarts
 (liquid)

Hitch Pins

- Red Head Forged Hitch Pins 3
- Cold Forged Hitch Pins..... 3
- Premium Hitch Pins 3
- Economy (Clevis) Hitch Pins..... 3
- Drop Forged Hitch Pins 4
- Bent Forged Hitch Pins..... 4
- Handle-Lok Hitch Pins..... 4
- Handle-Lok Hitch Pins - Small..... 4

Clevises

- Farm Straight Clevises 5
- Farm Twisted Clevises..... 5
- Farm Screw Pin Clevises 5
- Farm Utility Clevises 5
- General Purpose Clevis..... 6
- Farm Double Clevises..... 6
- T-Handle Clevis Pins..... 6

Drawbars

- Tractor Drawbar Hook..... 6
- One-Piece Drawbars 7
- Swinging Drawbar 7

Stabilizers

- Stabilizer Arms & Kits..... 7
- Stay Straps 7
- Stabilizer Pins 7

Ratchet Jack & Hydraulic Cylinder Pins

- Ratchet Jack & Hydraulic Cylinder Pins 8

Top Links

- Forged Top Links..... 8
- Superlinks/O.E.M. Links 8
- Forged Top Link Replacement Ends 9

Lift Arms

- Lift Arm..... 9
- Lift Arm Leveling Assembly..... 9

Replacement Balls & Sockets

- Forged Weld-On Ball Sockets..... 9
- Replacement Balls 10

Pins

- Lift Arm Pins 10
- Top Link Pins..... 10
- Universal (Adjustable) Clevis Pins..... 11
- Lynch Pins..... 11

Bushings

- Top Link & Lift Arm Bushings..... 12

Clips

- Hair Pin Clips..... 12
- Twist Clips..... 12

PTO Items

- PTO Adapters..... 13
- PTO Shafts..... 13
- PTO Accessories..... 13

Quick Hitch Items

- Quick Hitches..... 14
- Quick Hitch Adapter Bushings..... 14

Wheelspinners

- Wheelspinners..... 14

Stroke Controls

- Stroke Controls 14

Chain Items

- Roller Chain..... 15
- Connecting/Offset Links 15
- Roller Chain Breakers 15
- Tractor Tool Boxes 15

Tractor Replacement Parts

- Rain Caps 16

Miscellaneous

- Stroke Controls 16
- Rain Caps 16
- Set Collars..... 16
- Post Drivers..... 16

Sprockets, Hubs, Idlers, and Pullers

- Sprockets 17
- Hubs 17
- Idlers 17
- Pulleys 17

Red Head Forged Hitch Pins



Part No.	Dia. (in.)	Usable Length (in.)	Wgt. Ea. (lbs.)
71500	1/2	3-5/8	0.6
71501	5/8	4	0.8
71502	5/8	5-1/2	1.2
71503	3/4	4	1.1
71504	3/4	6-1/2	1.6
71506	7/8	6-1/2	1.9
71508	1	7-1/2	2.7
71510	1-1/8	8-1/2	3.8
71512	1-1/4	8-1/2	4.7
71514	1-1/2	8-1/2	5.5
71515	1-3/4	8-1/2	7.0
71516	2	8-1/2	8.5
71517	1-1/4	12	8.5
71518	1-1/2	13	9.0

- Our best hitch pin
- Our best selling pin
- Made of tensile steel
- DOUBLE HEAT TREATED
- One-piece forged pin
- Red vinyl coated handle
- Black powder coated pin finish
- Includes zinc plated clip
- 1-3/4" & 2" - Grade 8 alloy steel

Cold Forged & Machined Hitch Pins



Cold Forged Part No. W/Clip	Dia. (in.)	Usable Length (in.)	Wgt. Ea. (lbs.)
75180	3/8	3-1/2	0.3
75190	1/2	4-1/4	0.4
75200	5/8	4-1/4	0.6
74880	5/8	6-1/4	0.8
75210	3/4	4-1/4	0.9
74890	3/4	6-1/4	1.1
-	7/8	4-1/4	1.2
77880	7/8	6-1/4	1.5
-	1	4-1/4	1.5
77890	1	6-1/4	1.9
77900	1-1/8	6-1/4	2.4
78000	1-1/4	6-1/4	2.9
-	1-1/4	7-1/2	2.9

- High carbon steel
- Spring wire handle
- Includes clip or lynch pin and chain
- Zinc plated

Premium Hitch Pins



Part No.	Dia. (in.)	Usable Length (in.)	Wgt. Ea. (lbs.)
71600	1/2	4	0.4
71601	5/8	4	0.6
71602	5/8	6	0.8
71603	3/4	4-1/4	0.9
71604	3/4	6-1/4	1.1
71605	7/8	4-1/4	1.2
71606	7/8	6-1/2	1.6
71607	1	6-3/4	2.0
71608	1-1/8	7	2.6
71609	1-1/4	7	3.1

- One-piece forged pin
- High carbon steel
- Heat treated to grade 5
- Spring wire swivel handle
- Clip included
- Zinc plated
- For the toughest applications
- Meets or exceeds OEM specs

Economy (Clevis) Hitch Pins



Part No.	Dia. (in.)	Usable Length (in.)	Wgt. Ea. (lbs.)
77101	5/8	5-1/2	0.6
77102	3/4	5-1/2	0.8
77103	7/8	5-1/2	1.1
77104	1	5-3/4	1.5
77105	1-1/8	5-3/4	1.9

- Our lowest priced pin
- Medium carbon steel pin
- Zinc plated
- 3/4" and 1" can be used as top link pins with extra large head for worn holes

Drop Forged Hitch Pins



Part No.	Dia. (in.)	Usable Length (in.)	Wgt. Ea. (lbs.)
71415	7/16	3-1/2	0.3
71420	1/2	3-1/2	0.4
71425	5/8	3-3/4	0.6
71430	3/4	4	0.9
71435	7/8	4-1/4	1.2
71440	1	4-3/4	1.6
71445	5/8	6	0.8
71450	3/4	6-1/4	1.1
71455	7/8	6-1/2	1.5
71460	1	6-3/4	2.1
71465	1-1/8	7	2.7
71470	1-1/4	7	3.4

- Drop forged pin
- High tensile steel
- Heat treated
- Pin painted bright red
- Zinc plated, spring wire handle
- Includes zinc plated clip

Bent Hitch Pins



Part No.	Dia. (in.)	Usable Length (in.)	Wgt. Ea. (lbs.)
71410	1/2	3	0.3
71411	5/8	3	0.5
71412	3/4	3-1/2	0.8

- Fits lawn tractors and snow plows
- High carbon steel pin
- Zinc plated
- Includes zinc plated clip

Handle-Lok Hitch Pins



Part No.	Dia. (in.)	Usable Length (in.)	Wgt. Ea. (lbs.)
75195	1/2	4-1/4	0.5
75205	5/8	4-1/4	0.7
75215	3/4	4-1/4	1.0
74895	3/4	6-1/4	1.2
77885	7/8	6-1/4	1.5
77895	1	6-1/4	1.9

- Spring steel wire holds pin in place
- High carbon steel pin
- Zinc plated

Handle-Lok Hitch Pins - Small

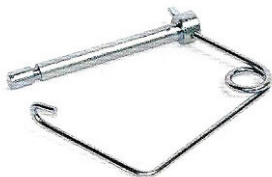

Part No.	Dia. (in.)	Usable Length (in.)	Wgt. Ea. (lbs.)
75142	1/4	1-3/4	0.6
75143	1/4	2-1/8	0.6
75162	5/16	2-1/4	1.0
75163	5/16	2-1/2	1.2
75182	3/8	1-1/2	1.5
75183	3/8	2-3/8	1.9
75124 Large size	1/2	3-1/2	0.5

- Spring steel wire holds pin in place
- Grooved pin to secure wire
- High carbon steel pin
- Zinc plated

Farm Straight Clevises



Part No.	Pin Dia. (in.)	Body Size (in.)	Opening (in.)	Max WLL* (lbs.)	Wgt. Ea. (lbs.)
78158	1/2	5/8 x 3-1/4	7/8	6,000	1.4
78134	5/8	3/4 x 3-3/4	1-5/16	12,000	2.3
78178	3/4	7/8 x 3-1/4	1-5/16	16,000	3.0
78187	3/4	7/8 x 4-1/4	1-5/16	16,000	3.6
78190	7/8	15/16 x 4-5/8	1-7/16	20,000	4.2
78195	1	5/8 x 3-1/4	2-1/8	25,000	6.0

- Black powder coated finish
- Zinc plated pin and clip
- Forged for better consistency in strength, quality and conformity

Farm Twisted Clevises



Part No.	Pin Dia. (in.)	Body Size (in.)	Opening (in.)	Max WLL* (lbs.)	Wgt. Ea. (lbs.)
78258	1/2	5/8 x 3	7/8	6,000	1.4
78234	5/8	3/4 x 3-1/2	1-5/16	12,000	2.3
78278	3/4	7/8 x 3	1-5/16	16,000	3.0
78287	3/4	7/8 x 3-7/8	1-5/16	16,000	3.6
78290	7/8	15/16 x 4-1/4	1-7/16	20,000	4.2
78295	1	1 x 5	2-1/8	25,000	6.0

- Black powder coated finish
- Zinc plated pin and clip
- Forged for better consistency in strength, quality and conformity

Farm Screw Pin Clevises



Part No.	Body Size (in.)	Max WLL* (lbs.)	Wgt. Ea. (lbs.)	Pkg. No.	Pkg. Type	Pcs/ Pkg.	Pkg. Wgt. (lbs.)
78646	1/4 x 1-1/8	1,000	0.12	98646	C	2	0.2
78647	5/16 x 1-1/4	2,000	0.2	98647	C	2	0.4
78648	3/8 x 1-7/16	3,000	0.3	98648	C	1	0.4
78649	7/16 x 1-11/16	4,000	0.5	98649	C	1	0.8
78650	1/2 x 15/16	6,500	0.75	98650	C	1	0.9
78651	5/8 x 2-1/2	9,000	1.3	98651	C	1	1.4
78652	3/4 x 3	13,000	2.2	98652	C	1	2.4
78653	7/8 x 3-1/4	15,000	3.5				
78654	1 x 3-3/4	17,000	5.0				

Package Type "B" Bagged • Package Type "C" Clamshell

- Black powder coated finish
- Zinc plated pin and clip
- Forged for better consistency in strength, quality and conformity

Farm Utility Clevises



Part No.	Body Size (in.)	Max WLL* (lbs.)	Opening (in.)	Wgt. Ea. (lbs.)	Pkg. No.	Pkg. Type	Pcs/ Pkg.	Pkg. Wgt. (lbs.)
78546	1/4 x 7/8	1,000	15/32	0.1	98546	C	2	0.2
78547	5/16 x 1	1,500	17/32	0.2	98547	C	2	0.4
78548	3/8 x 1-1/4	2,000	21/32	0.3	98548	C	1	0.6
78549	7/16 x 1-1/2	3,000	23/32	0.4	98549	C	1	0.7
78550	1/2 x 1-11/16	6,000	13/16	0.6	98550	C	1	0.7
78551	5/8 x 2	9,000	1-1/16	1.2	98551	C	1	1.3

Package Type "B" Bagged • Package Type "C" Clamshell

- Black powder coated finish
- Zinc plated pin and clip
- Forged for better consistency in strength, quality and conformity

General Purpose Clevis



Part No.	Body Size (in.)	Opening (in.)	Max WLL* (lbs.)	Wgt. Ea. (lbs.)
78465	3/4 x 6-3/16	2-1/2	10,000	3.3

- Black powder coated finish
- Zinc plated pin and clip
- Forged for better consistency in strength, quality and conformity

Farm Double Clevises



Part No.	Chain Size (in.)	Max WLL* (lbs.)	Wgt. Ea. (lbs.)	Pkg. No.	Pkg. Type	Pcs/ Pkg.	Pkg. Wgt. (lbs.)
78605	1/4 or 5/16	4,700	0.4	98605	C	1	0.4
78606	3/8	6,600	0.5	98606	C	1	0.6
78608	7/16 or 1/2	11,300	1.0	98608	C	1	1.0

Package Type "B" Bagged • Package Type "C" Clamshell

- One-piece forged steel
- HEAT TREATED
- Use with high test chain
- Black powder coated finish

T-Handle Clevis Pins

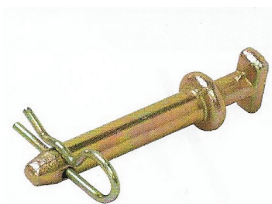

Part No.	Pin Dia. (in.)	Usable Length (in.)	Wgt. Ea. (lbs.)
78812	1/2	2-1/2	0.4
78813	5/8	3-1/8	0.5
78814	3/4	3-1/4	0.7
78815	7/8	3-3/4	1.2
78816	1	4-1/4	1.5

- High carbon steel
- Drop forged
- HEAT TREATED
- Zinc plated
- * Includes clip

Tractor Drawbar Hook



Fits all tractor drawbars with 3/4" holes, up to and including 1-1/4" thick. Use with chain sizes 5/16" to 1/2", including high-test chain. Working Load Limit - 9,000 lbs.

- Part No. 78834
- Hot forged, high carbon steel
- HEAT TREATED
- Includes 3/4" pin
- Hook - black powder coated
- Replacement pin and clip - Part No. 78835



78835

One-Piece Drawbars



Part No.	CAT	Lift Arm		Hole Dia. (in.)	Pin Dia. (in.)	Thickness (in.)	Width (in.)	Wgt. Ea. (lbs.)
		Spacing (in.)	No. Of Holes					
70418	0	20	7	5/8	5/8	5/8	2	6.8
70419	1	20	7	3/4	7/8	1	2-1/2	13.5
70411	1	26	11	3/4	7/8	1	2-1/2	16.5
70421	2	26	11	3/4	1-1/8	1-1/4	3	27.0
70432	2	32	13	3/4	1-1/8	1-1/4	3	33.0
70441	3	38	5	1-1/2	1-1/2	1-3/4	3-1/2	61.0

- One-piece 3-point hitch cross drawbars
- Black powder coated finish

Swinging Drawbar



Fits: Ford 2N, 8N, 9N, NAA; 630, 631, 640, 641, 650, 651, 660, 661; Ferguson T020, TP030; Massey-Ferguson 35 and 50

- Part No. 70412
- 30" (762mm) overall length
- 3/4" (19mm) first hitch pin hole
- 5/8" (16mm) second pin hole
- Weight: 15.9 lbs.
- Black powder coated finish

Stabilizer Arms & Kits

70176

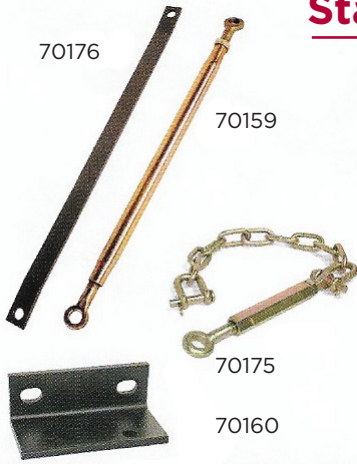

70159

70175

70160

Part No.	CAT	Type	Size (in.)	Holes (in.)	Centers (in.)	Wgt. Ea. (lbs.)
70176	1	Flat Bar	3/8 x 1-3/4	7/8	31-9/16	6.0
70177	1	Flat Bar	3/8 x 1-3/4	7/8	33-1/8	6.4
70178	1	Flat Bar	3/8 x 1-3/4	7/8	31-1/8 & 33-3/4	7.0
70159	1	Adjustable	7/8 Thread	7/8	27-1/2 & 35	6.5
70160	1	Bracket	Fits Kits	RH/LH	5/8	3.7
70175	-	Chain	-	-	-	5.0

Kit No. 70611
Fits: All Ferguson, MF 35 and 50, Ford 2N, 8N, 9N, 600 and 800

Kit No. 70612
Fits: MF 35, 50, 135, 150, 1962 and later low clearance

Kit No.	CAT	Type	Contains	Wgt. Ea. (lbs.)
70611	1	Flat Bar	2 x 70176, 2 x 73169, 2 x 72650, 2 x 70160	20.3
70612	1	Flat Bar	2 x 70177, 2 x 703169, 2 x 72650, 2 x 70160	20.8

- 70175 Universal stabilizer chain for most CAT 1 applications

Stay Straps



Part No.	Description	Application
70173	Lower Stay Strap	Cat 1 fits all Ferguson models. Ford 2N, 8N, 9N, NAA, 600, 700, 800, 900 Oliver550, and allOliver 3-point conversions, Massey-Ferguson 35 and 50
70174	Upper Stay Strap	Cat 1 fits all Ferguson models. Ford 2N, 8N, 9N, NAA, 600, 700, 800, 900 Oliver550, and allOliver 3-point conversions, Massey-Ferguson 35 and 50

- Black powder coated finish

Stabilizer Pins



Part No.	Pin Dia. (in.)	Thread			Replaces	Wgt. Ea. (lbs.)	Pkg.			
		Dia. (in.)	Usable (in.)	Overall (in.)			No.	Pkg. Type	Pcs/ Pkg. (lbs.)	
73169	7/8	5/8	3/8	2-5/8	Ford 230044 MF 181777M1	0.3	82260	B	2	0.7
							92260	C	2	0.8
70169	7/8	5/8	1/2	2-7/8	Same, but longer usable	0.3	82261	B	2	0.7
							92261	C	2	0.8
73107	7/8	5/8	7/8	3-1/8	Ford 141185	0.4				

- Zinc plated

Package Type "B" Bagged • Package Type "C" Clamshell

Ratchet Jack & Hydraulic Cylinder Pins



Part No.	Body Size (in.)	Opening (in.)	Max WLL* (lbs.)	Wgt. Ea. (lbs.)
71542	3/4 x 6-3/16	2-1/2	10,000	3.3

Part No.	Description	Pin Dia. (in.)	Usable Length (in.)	Overall Length (in.)	Wgt. Each (lbs.)	Pkg. No.	Pkg. Type	Pcs/Pkg.	Pkg. Wgt. (lbs.)
71544	w/2 Clips	1	2-3/4	3-1/2	0.7	91544	C	2	1.5
71545	w/2 Clips	1	3-1/4	3-7/8	0.8	91545	C	2	1.7
71546	w/2 Clips	1	3-3/8	4	.14	-	-	-	-
70017	Clip Only	-	-	-	.002	90017	C	4	.01

- Includes 2 pins & handle
- Black powder coated finish

Package Type "B" Bagged • Package Type "C" Clamshell

Forged Top Links



Part No.	CAT	Type*	Pin Holes Dia. (in.)	Thread Dia. (in.)	Body Length (in.)	Hole Center Adjustment (in.)	Wgt. Ea. (lbs.)
70330	1	Std.	1/2	1	11-1/4	16 to 23	6.7
70331	1	Std.	3/4	1-1/8	16	20-1/2 to 29	8.4
70332	1	Std.	3/4	1-1/8	16	20-1/2 to 29	7.6
70335	1	Std.	3/4	1-1/8	20	24-1/2 to 32	9.1
70338	1&2	Std.	3/4 & 1	1-1/8	16	20-3/4 to 31	9.4
70339	1&2	Std.	3/4 & 1	1-1/8	20	24-3/4 to 35	10.1
70480	1	Std.	3/4	1-1/8	13	17-1/2 to 26-1/2	7.7
70486	2	Std.	1	1-1/8	13	18 to 27-3/4	9.1
70336	2	Std.	1	1-1/8	16	21 to 33	10.4
70340	2	Std.	1	1-1/8	16	21 to 33	9.8
70337	2	Std.	1	1-1/8	20	25 to 36-1/2	11.1
73470	0	Std.	5/8	3/4	7-1/2	10-3/4 to 16-3/8	2.9
73473	2	H.D.	1	1-1/4	15	20-1/2 to 31-1/2	14.9
73474	2	H.D.	1	1-1/4	19	24-1/2 to 35-1/2	15.9
73477	3	H.D.	1-1/4	1-3/8	19	25-1/2 to 36-1/2	23.0
70333	1&2	Std.	-	-	-	Adjusting Rod	0.5
70348	1&2	Std.	-	1-1/8	-	Locking Collar	0.2

- Zinc plated ends

Superlinks/O.E.M. Links



Part No.	CAT	Pin Holes Dia. (in.)	Thread Dia. (in.)	Body Length (in.)	Hole Center Adjustment (in.)	Wgt. Ea. (lbs.)
73475	2	1	1-1/4	11-1/4	20-9/16 to 30-3/4	6.7
73476	3	1-1/4	1-3/8	16	25-13/16 to 35-3/16	8.4
73478*	1	25/32-1	1-1/8	16	21-5/8 to 30	7.6
73479*	2	1	1-1/8	20	21-5/8 to 31	9.1
73480**	2	1	1-1/4	16	22 to 29-3/4	9.4
73481***	2	3/4-HQ-2	1-1/4	20	22-3/4 to 30	10.1
73482**	2	7/8-1	1-1/4	13	22 to 29-3/4	13.70
73483***	2	7/8-HQ-2	1-1/4	13	22-3/4 to 30	16.75

*Top link w/locking clip
 **Top link w/locking clip & knuckle
 ***Top link w/locking clip, knuckle & quick hitch

- Top links that meet original equipment standards
- Twice as strong as the standard aftermarket top link
- Ultimate tensile strength - 61,380 lb.
- Safe working load limit - 20 tons
- Links for all makes suitable for John Deere

Part No.	Application
73475	Universal
73476	Universal
73482	John Deere 2510, 2520, 3020, 4000, 4030, 4040, 4050, and 4055 standard & row crop tractors
73483	John Deere 2510, 2520, 3020, 4000, 4030, 4040, 4050, and 4055 standard & row crop tractors
73478	Fits all Manheim utility tractors, except 3130, 3140, and 3040
73479	Fits most CAT 2standard and row crop tractors
73480	Fits Manheim utility tractors, plus 520, 530, 620, 630, 720, 730, 3010, and 4010
73481	Fits Manheim utility tractors, plus 520, 530, 620, 630, 720, 730, 3010, and 4010

Forged Top Link Replacement Ends



Part No.	Thread	CAT	Pin Holes Dia. (in.)	Thread Dia. (in.)	Wgt. Ea. (lbs.)
70342	LH	1	3/4	1-1/8	2.4
70343	RH	1	3/4	1-1/8	2.4
70346	LH	2	1	1-1/8	3.0
70347	RH	2	1	1-1/8	3.0
73246	LH	2 HD	1	1-1/4	5.5
73244	RH	2 HD	1	1-1/4	5.5
74951	LH	3 HD	1-1/4	1-3/8	5.9
74950	RH	3 HD	1-1/4	1-3/8	5.9

• Zinc plated

Lift Arm



Part No.	CAT	Pin Holes Dia. (in.)	Ball Centers (in.)	Wgt. Ea. (lbs.)
70500	1	7/8	31-3/4	10.8

- Fits: All Ferguson, Massey 35 and 50, Ford 2N, 8N, 9N, NAA Deere 1010
- Fits up to 50 h.p.
- Fits right or left hand
- Forged ball sockets
- Black powder coated finish
- Heavy duty

Lift Arm Leveling Assembly



Part No.	CAT	Thread (in.)	Overall (in.)	Wgt. Ea. (lbs.)
70152	1	7/8 NF	19-1/4	6.6

- Fits old Ford & Ferguson
- Replaces Ford NCA 577A
- Black powder coated finish

Forged Weld-On Ball Sockets



Part No.	Type	CAT	A (in.)	B (in.)	C (in.)	D (in.)	E (in.)	F (in.)	Pkg. Wgt. (lbs.)	Pkg. No.	Pkg. Type	Pcs/ Pkg.	Pkg. Wgt. (lbs.)
70310	Top Link	1	2	3/4	1-1/8	1/2	1-3/4	2-1/4	0.9	90310	C	1	1.0
70311	Top Link	2	2-3/8	1	1-1/8	1/2	2	2-5/8	1.4	90311	C	1	1.5
71338	Lift Arm-Straight	1	2-3/4	7/8	2-3/8	5/8	1-3/8	2-5/8	1.7	91338	C	1	1.8
71342	Lift Arm-Straight	2	3-1/8	1-1/8	2-3/4	3/4	1-3/4	3-1/8	2.8	91342	C	1	2.9
71344	Lift Arm-Straight	3	3-3/8	1-7/16	3	3/4	1-3/4	3-1/2	3.0				
71351	Lift Arm-Bent	1	4	7/8	1-7/8	5/8	1-3/8	2-5/8	2.0				
71352	Lift Arm-Bent	2	4	1-1/8	1-7/8	5/8	1-3/4	3-1/8	2.7				

Package Type "B" Bagged • Package Type "C" Clamshell

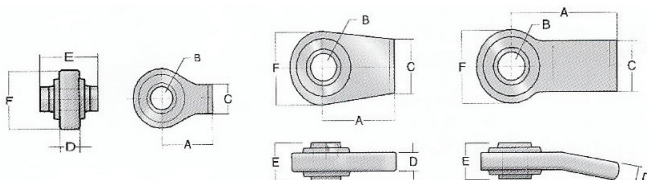

Replacement Balls



Part No.	CAT	Type	Pin Hole (in.)	O.D. (in.)	Width (in.)	Replaces	Wgt. Each (lbs.)	Pkg. No.	Pkg. Type	Pcs/ Pkg.	Pkg. Wgt. (lbs.)
								82273	B	2	2.3
70056	1	Ford - Lift Arm	7/8	2-1/4	1-3/8	E1ADDN995233	1.1	82277	B	1	1.2
								90056	C	1	1.3
70057	2	Ford - Lift Arm	1-1/8	2-1/4	1-3/4	C5NN557A	1.1	82274	B	2	2.3
								82278	B	1	1.2
								90057	C	1	1.3
73057	2	Ford - Lift Arm Narrow	1-1/8	2-1/4	1-3/8	C5NN557B	0.9	82275	B	2	1.9
								82282	B	1	1.0
								93057	C	1	1.1
73054	1	Deere & Oliver Top Link	3/4	2	1-3/4	F2680 105968A	0.9	82270	B	1	1.0
								93054	C	1	1.1
73055	2	Deere & Oliver Top Link	1	2	1-3/4	F2681 104585A	0.8	82271	B	1	0.9
								93055	C	1	0.9
73056	2	Oliver - Lift Arm	1-1/8	2	1-3/4	104591A	0.8	82272	B	2	1.7
								82279	B	1	0.9
								93056	C	1	1.0

Package Type "B" Bagged • Package Type "C" Clamshell

Lift Arm Pins

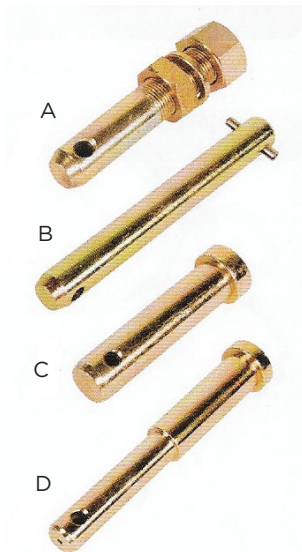

Part No.	CAT	Type	Style	Usable	Pin Dia. (in.)	Thread Dia. (in.)	Overall (in.)	Wgt. Ea. (lbs.)
73137	0	Adjustable	A	Adjustable	5/8	5/8	4	0.4
73031	1	Clevis	C	4-1/4	7/8	1-1/4	5-1/4	2.7
73134	1 & 2	Clevis	C	8	7/8	-	-	2.8
70211	1	Adjustable	A	Adjustable	7/8	7/8	5-5/16	1.1
70200	1	Forged	A	1-3/4	7/8	7/8	5-1/2	1.1
73000	1	Adjustable-XL	A	Adjustable	7/8	7/8	6-1/4	1.3
73004	1	Forged-XL	A	2-1/4	7/8	7/8	6-1/2	1.3
73001	1 to 2	Adjustable	A	Adjustable	1-1/8	7/8	5-3/16	1.4
70202	1 to 2	Forged	A	1-3/4	1-1/8	7/8	5-1/4	1.5
73178	1 to 2	Forged-XL	A	2-1/4	1-1/8	7/8	6-5/16	1.6
73022	2 to 1	Forged	A	1-3/4	7/8	1-1/8	5-3/4	1.8
70213	1 & 2	Forged	A	2-1/16	7/8 & 1-1/8	1	8	1.9
73002	2	Adjustable	A	Adjustable	1-1/8	1-1/8	6-1/4	2.3
73006	2	Forged	A	1-3/4	1-1/8	1-1/8	6-1/4	2.3
73005	2 to 3	Forged	A	1-7/8	1-7/16	1-1/8	5-7/8	3.0
73007	2	Forged	A	2	1-7/16	1-3/8	5-7/8	3.5
73133	2	Clevis	C	5	1-1/8	-	-	1.8
73032	2	Clevis	B	4-7/16	1-1/8	-	6-1/2	1.8
73132	2	Clevis	B	7-5/8	1-1/8	-	9-1/4	2.9
73033	3	Clevis	C	4-11/16	1-7/16	-	6-1/2	2.9
73039	2 & 3	Clevis	D	4 & 4-1/2	1-1/8 & 1-7/16	-	9-1/4	3.4

- High carbon steel pin
- Zinc plated

Top Link Pins

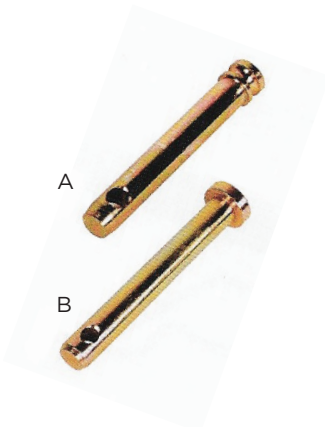

Part No.	CAT	Style	Replaces	Dia. (in.)	Usable (in.)	Overall (in.)	Wgt. Ea. (lbs.)
73173	0	A	-	5/8	2-3/4	4-7/16	0.4
70073	1	A	Ford 9N-560 MF 195647M1	3/4	2-3/4	4-1/2	0.5
70074	1	A	MF 195589M1 AC 339942	3/4	3-7/8	5-1/2	0.6
70077	1	A	Ford E381T9	3/4	4-3/4	6-3/8	0.8
77102	1	B	-	3/4	5-1/2	-	1.0
70076	2	A	Ford C5NN560A MF 185873M91	1	3-9/16	5-1/4	1.2
73011	2	A	Ford C5NN486A	1	4-5/16	6	1.3
77104	2	B	-	1	5-3/4	-	1.6
73026	3	A	-	1-1/4	4-7/16	6-1/2	2.1

- Carbon steel pin
- Zinc plated
- Forged ball sockets
- Type B features extra large head for worn or oversized holes

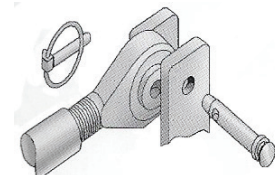

Universal (Adjustable) Clevis Pins



Bulk No.	Pin Hole (in.)	Overall (in.)	Wgt. Each (lbs.)	Pkg. No.	Pkg. Type	Pcs./Pkg.	Pkg. Wgt. (lbs.)
71100	1/4	2	.02	82310	B	4	.08
				92310	C	4	.10
71101	5/16	2	.04	82311	B	4	.16
				92311	C	3	.13
71102	3/8	2	.05	82312	B	2	.10
				92312	C	2	.11
71103	7/16	2	0.8	82313	B	2	.16
				92313	C	2	.17
71104	1/2	2	.11	82314	B	2	.22
				92314	C	3	.25
71105	7/16	2-1/2	.14	92315	C	3	.30
71106	1/2	2-1/2	.13	82316	B	2	.26
				92316	C	2	.27
71107	7/16	3	.14	92317	C	2	.30
71108	1/2	3	.15	92318	C	2	.32
71109	5/8	3	.16	92319	C	2	.34
71110	3/4	3	.17	92320	C	1	.36

- Multiple holes
- Adjustable length
- Cut off excess length
- Zinc plated

Package Type "B" Bagged • Package Type "C" Clamshell

Lynch Pins



72703



72648

Bulk No.	Pin Dia. (in.)	Type	CAT	Pcs./Ctn.	Wgt. Each (lbs.)	Pkg. No.	Pkg. Type	Pcs./Pkg.	Pkg. Wgt. (lbs.)
73548	3/16	Std.	0	100	.02	82204	B	2	.05
						82211	B	25	.62
						92204	C	4	.10
72646	3/16	w/Chain	0	100	.07	-	-	-	-
72709	5/16	Std.	1 & 2	100	1.0	82205	B	2	.20
						82212	B	10	1.0
						92205	C	4	.40
72647	5/16	w/Chain	1 & 2	100	6.0	-	-	-	-
72704	1/4	Std.	1 & 2	100	.07	82201	B	2	.15
						82207	B	5	.37
						82213	B	10	.75
						92207	C	4	.30
						92213	B	10	.75
72648	1/4	w/Chain	1 & 2	100	.12	-	-	-	-
72703	7/16	Std.	1 & 2	100	.10	82200	B	2	.20
						82206	B	5	.53
						82214	B	25	2.6
						82219	B	10	1.1
						92206	C	4	.43
72650	7/16	w/Chain	1 & 2	100	.15	82203	B	2	.30
						92203	C	2	.33
72698	7/16	Long	1, 2, 3	100	.12	82215	B	2	.25
						82216	B	10	1.2
						92215	C	4	.50
73027	7/16	Black HD	1, 2, 3	100	.12	82202	B	2	.26
						82217	B	10	1.3
						92202	C	4	.50
						93027	C	2	.26

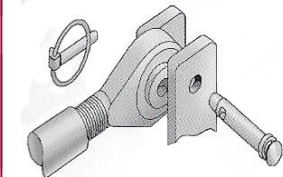

- Carbon steel forged pins
- Spring steel snap rings
- Zinc plated
- No. 73027 Ring powder coated

Package Type "B" Bagged • Package Type "C" Clamshell

Top Link & Lift Arm Bushings

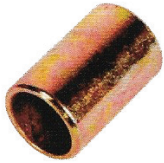

Part No.	Type	CAT	I.D. (in.)	O.D. (in.)	Overall Length (in.)	Wgt. Ea. (lbs.)	Pkg.			
							Pkg. No.	Pkg. Type	Pcs/ Pkg.	Wgt. (lbs.)
70353	Top Link	1 to 2	3/4	1	2	.18	82250 93250	B C	1 2	1.9 2.0
73530	Top Link	1 to 2	3/4	1	1-5/8	.15	-	-	-	-
73008	Top Link	2 to 3	1	1-1/4	2	.24	82251 93008	B C	1 1	1.0 1.1
70351	Lift Arm Ford C7NN6992A	1 to 2	7/8	1-1/8	1-3/4	.19	82252 93252	B C	1 1	1.0 1.1
73510	Lift Arm Deere F2684	1 to 2	7/8	1-1/8	1-3/8	.18	-	-	-	-
73009	Lift Arm	2 to 3	1-1/8	1-7/16	1-3/4	.28	82253 93009	B C	2 2	.57 .60
73012	Lift Arm	2 to 3	1-1/8	1-7/16	2-3/4	.50	82255 92255	B C	2 2	1.1 1.2
73013	Lift Arm	2 to 3	1-1/8	1-7/16	3-1/4	.52	-	-	-	-
73010	Lift Arm	2 to 3	1-1/8	1-1/16	2-1/2	.44	82254 93010 82262 92262	B C B C	2 2 3 3	.89 .90 .57 .60
							Contains: 70353 x 1 70351 x 2			
							83162 B 3 .81 93162 C 3 .85			
							Contains: 73008 x 1 73009 x 2			

• Zinc plated

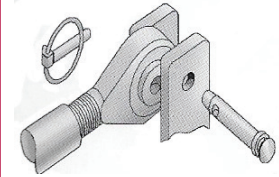

Package Type "B" Bagged • Package Type "C" Clamshell

Hair Pin Clips

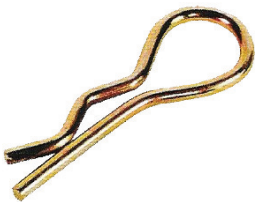

Part No.	Wire Dia. (in.)	Overall (in.)	Fits Pin Dia. (in.)	Wgt. Ea. (lbs.)	Pkg.				
					Pkg. No.	Pkg. Type	Pcs/ Pkg.	Wgt. (lbs.)	
70007	3/32	2-5/16	1/4 to 5/8	.010	-	-	-	-	
70008	5/64	1-3/4	5/16 to 1/2	.007	83108 93108	B C	12 9	.07 .07	
70009	3/32	1-3/4	3/8 to 5/8	.008	83109 93109	B C	12 9	.08 .09	
70010	1/8	2-1/16	1/2 to 7/8	.022	83110 93110	B C	8 6	.22 .20	
70012	5/32	3	5/8 to 1	.038	83112 93112	B C	7 5	.38 .30	
70013	3/16	4-3/16	3/4 to 1-1/4	.075	83113 93113	B C	3 2	.75 .52	
70014	1/4	4-1/4	7/8 to 1-1/2	.116	83114 93114	B C	2 2	1.2 1.3	
70015	5/16	3-7/8	3/4 to 1-1/4	.195	83115 93115	B C	2 1	2.0 2.1	
70017	-	-	1	.01	90017	C	4	.10	
70019	3/8	3-5/8	3/4 to 1-1/4	.150	83119 93119 83116 93116	B C B C	2 2 14 14	1.5 1.6 .50 .51	
					Contains: 70009 x 3, 70010 x 4, 70012 x 4, 70013 x 3				

• Spring steel wire
• Zinc plated

Package Type "B" Bagged • Package Type "C" Clamshell

Twist Clips

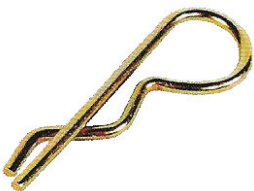

Part No.	Wire Dia. (in.)	Overall (in.)	Fits Pin Dia. (in.)	Wgt. Ea. (lbs.)	Pkg.			
					Pkg. No.	Pkg. Type	Pcs/ Pkg.	Wgt. (lbs.)
70020	1/8	2-1/16	1/2 to 7/8	.022	93120	C	6	.030
70021	5/32	3	5/8 to 1	.038	93121	C	5	.045
70022	3/16	4-3/16	3/4 to 1-1/4	.075	93122	C	2	.085

• Spring steel wire
• Zinc plated

Package Type "B" Bagged • Package Type "C" Clamshell

PTO Adapters



Part No.	Description	Max. H.P.	Female Spline (in.)	Male Spline (in.)	Extends PTO (in.)	Overall (in.)	Similar to Hub City No.	Pkg. Wgt. (lbs.)
70253	Forged Increaser	70	1-1/8 x 6	1-3/8 x 6	1-1/8	3	03-32-00018	1.4
70249	Sleeve Increaser Fits all except Ford	70	1-1/8 x 6	1-3/8 x 6	0	2-1/4	03-32-00352	0.2
70250	Sleeve Increaser	70	1-3/8 x 6	1-1/8 x 6	0	1-7/8	03-32-00363	0.2
70252	Forged Increaser	70	1-3/8 x 6	1-1/8 x 6	2-1/2	4-5/8	03-32-03531	1.3
70251	Forged Reducer	70	1-3/8 x 6	1-1/8 x 6	2-3/4	5-3/8	03-32-00400	1.4
70255	Forged Extender	70	1-3/8 x 6	1-3/8 x 6	3	5-3/8	03-32-00378	2.0
73029	21 to 6 Spline 1000 to 540 RPM	70	1-3/8 x 6	1-3/8 x 6	3-1/4	5-7/8	03-32-00373	2.0
73030	21 to 6 Spline QR 1000 to 540 RPM	70	1-3/8 x 6	1-3/8 x 6	4-1/8	6-3/8	03-32-01375	3.2
73034	QR Extender	70	1-3/8 x 6	1-3/8 x 6	4-1/8	6-3/8	03-32-00010	2.8
73028	21 QR Extender 1000 RPM	70	1-3/8 x 21	1-3/8 x 21	4-1/8	5-7/8	03-32-02121	3.1
73038	6 to 21 Spline QR 540 to 1000 RPM	70	1-3/8 x 6	1-3/8 x 21	4-1/8	5-7/8	03-32-00013	3.2
73035	20 to 6 Spline	100	1-3/4 x 20	1-3/8 x 6	4-5/8	7-1/2	03-32-00020	6.1
73041	**20 to 6 Spline Heavy-duty	150	1-3/4 x 20	1-3/8 x 6	5	7-7/8	03-32-00076	6.6
73036	20 to 21 Spline	100	1-3/4 x 20	1-3/8 x 21	4-5/8	7	03-32-00021	6.1
73042	**20 to 21 Spline Heavy-duty	150	1-3/4 x 20	1-3/8 x 21	5-1/2	7-7/8	03-32-00077	6.7
70660	Over-running Clutch Extender	*	1-3/8 x 6	1-3/8 x 6	3-3/4	6-3/4	03-31-00660	5.0
70670	Over-running Clutch Increaser	*	1-1/8 x 6	1-1/8 x 6	3-3/4	6-3/4	03-31-00670	5.0

- Used to increase or reduce the diameter, or extend the length of the tractor's power take-off shaft to fit an implement's PTO shaft
- Zinc plated finish
- **Newer, Heavy-duty, 20-spline models have been redesigned to be stronger, smaller and lighter to reduce rotating mass at higher RPM's

* Over-running clutches provide a safe means to protect operators and expensive machinery from situations when the inertia of a PTO driven implement exceeds and over-runs the tractor PTO speed. In such a case, the over-running coupler will free-wheel smoothly and safely. Over-running clutches will normally withstand applications requiring up to 65h.p. at 540 rpm and 100 h.p. at 1000 rpm. Extreme shock loads or drive line angularity will reduce this capability.

Quick Hitch Adapters

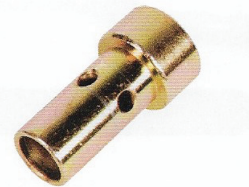

Quick Hitch Adapter Bushings

Bulk	CAT	I.D. (in.)	O.D. (in.)	Wgt. Ea. (lbs.)	Pkg. No.	Pkg. Type	Pcs/ Pkg.	Pkg. Wgt. (lbs.)
73015	2 to 3	1-1/8	1-7/16	1.1	93014	C	2	2.2
73016	1 to 3	7/8	1-7/16	1.4	93016	C	2	2.2
71148	Roll Pin	-	-	.01				

Package Type "B" Bagged • Package Type "C" Clamshell

- Fits most category 3 quick hitches
- Converts category 2 lift pins to category 3
- Two required per unit
- Use 7/16" x 1-3/8" roll pin to secure
- Clampak includes 2 roll pins
- Zinc plated

PTO Accessories



Part No.	Description	Type	Pin Dia. (in.)	Usable (in.)	Wgt. Ea. (lbs.)	Pkg. No.	Pkg. Type	Pcs/ Pkg.	Pkg. Wgt. (lbs.)
70264	Lock Pin	Round	1/4	2-1/4	0.2	92263	C	2	0.5
						92264	C	4	0.9
70266	Lock Pin	Round	5/16	2-1/4	0.2	82266	B	2	0.5
						92266	C	2	0.6
						92269	C	4	1.1
70276	Lock Pin	Square	5/16	2-1/4	0.2	82276	B	2	0.5
						92276	C	2	0.6
70265	Lock Pin	Round	3/8	2-1/4	0.2	92265	C	2	0.7
70275	Lock Pin	Square	3/8	2-1/4	0.2	92275	C	2	0.7
70278	Lock Pin	Square	3/8	2-1/2	0.2	-	-	-	-
71090	Yoke Pin Assy./PTO drive	-	-	-	0.3	91090	C	1	0.4
71091	Q.R. Pin Assy. Q.R. Adapter	-	-	-	0.3	91091	C	1	0.4
71145	Roll Pin fits 00660/00670	-	5/16	2	0.1	82283	B	5	0.3
						92283	C	5	0.3
71146	Roll Pin fits 00253	-	5/16	1-1/8	0.1	-	-	-	-

Package Type "B" Bagged • Package Type "C" Clamshell

- Spring steel wire
- Zinc plated

Wheelspinners



Part No.	Description	Wgt. Ea. (lbs.)
70949	Red Vinyl Wheel Spinner	.03
70950C	Camo Deluxe Wheel Spinner	
70951	Bake Lite Wheel Spinner	.03

Package Type "C" Clamshell

- Premium ball bearing suspension
- Bright zinc plated base and hardware

GATEWARE™



Part No.	Description	Pkg. Wgt. (lbs.)
77000	Two-Way Lockable gate latch, designed to accept padlock. Round tube gates 1-1/4" to 1-1/2" OD	5
77001	Gate anchor, holds livestock gate open in any position. Round tube gates 1-3/4" to 2" OD	4
77002	Gate wheel, allows gate to open and close with ease. Round Tube Gates 1-5/8" to 2" OD	4.1
77003	One-Way Lockable gate latch, designed to accept padlock. Round tube gates 1-5/8" to 2" OD	3.2
77006	Gate Hinge designed for round tube gates with 1-5/8" to 2" OD. 5/8" diameter and 6" long bolts	2.6
77007	Gate Hinge designed for round tube gates with a 2" OD. 3/4" diameter and 12" long bolts	5.9
77009	Tall Gate wheel, adjusts for gates with high ground clearance. Round tubes 1-5/8" to 2" OD	12
77010	Two-Way Lockable gate latch, designed to accept padlock. Round tube gates 1-5/8" to 2" OD	5

Benefits of Galvanized GATEWARE

- Corrosion Resistance
- Longevity
- Low Maintenance
- Versatility
- Toughness and Durability
- Resistant to Mechanical Damage
- Aesthetic Appeal

Assortments



Part No.	Description	Pkg. Wgt. (lbs.)
71005	5 x 7/8 in. x 1 in. hitch clips, 6 x 7/8 x 1-1/4 in. hitch clips, 20 x 5/8 in. x 1 in. hitch clips, 20 x 1/2 in. x 3/4 in. hitch clips, 30 x 3/8 in. x 1/2 in. hitch clips, 20 x 1/4 in. x 1/2 in. hitch clips	1
71040	16 - 3/16 in. x 1 7/16 in. lynch pins, 18 - 1/4 in. x 1 3/4 in. lynch pins, 6 - 5/16 in. x 1 3/4 in. lynch pins, 10 - 7/16 in. x 1 3/4 in. lynch pins	1
71070	150 cotter pins measuring 1/16 in. x 1 in., 150 x 3/32 in. x 1 in., 100 x 3/32 in. x 1 1/2 in., 75 x 1/8 in. x 1 1/4 in., 50 x 1/8 in. x 2 in., 30 x 5/32 in. x 2 1/2 in.	1
74109	Grease Zerk Fittings; Assorted; Metric grease fitting assortment: 31 pieces - Contains 6 -M6 straight, 3 -M6 90 degree, 4 -M6 45 degree, 3 -M8 straight, 3 -M8 90 degree, 2 -M10 straight, 2 M10 45 degree, 2 -M10 90 degree.	1
79104	Grease Zerk Fittings; Assorted; Grease fitting Assortment: 32 pieces. Contains 6 - 1/4"-28 straight, 3 - 1/4"-28 45 degree, 3 - 1/4"-28 90 degree, 4 - 3/26" drive, 4 - 5/16" drive, 6 - 1/8" pipe 45 degree, 3 - 1/8" pipe 90 degree	1

- Available in diverse assortments for convenient packaging
- Each assortment offers a variety of quantities, sizes, and styles
- Simple installation process
- Stringent quality control measures implemented to guarantee adherence to product standards

Roller Chain



Part No.	Chain No.	Unit (ft.)	Pitch (in.)	Part No.	Chain No.	Unit (ft.)	Pitch (in.)
76351	35	10	3/8	76603	60-H	10	3/4
76355	35	50	3/8	76801	80	10	1
76352	35-2	10	3/8	76805	80	50	1
76411	41	10	1/2	76802	80-2	10	1
76415	41	50	1/2	76803	80-H	10	1
76401	40	10	1/2	76100	100	10	1-1/4
76405	40	50	1/2	76120	120	10	1-1/2
76501	50	10	5/8	76241	A2040	10	1
76505	50	50	5/8	76245	A2040	50	1
76502	50-2	10	5/8	76251	A2050	10	1-1/4
76601	60	10	3/4	76255	A2050	50	1-1/4
76605	60	50	3/4	76261	A2060	10	1-1/2
76602	60-2	10	3/4	76551	CA550	10	1-41/64

Connecting/Offset Links



Connecting Links

Offset Links

Pkg. No.	Chain No.	Bagged Qty.	Pitch (in.)	Pkg. No.	Chain No.	Bagged Qty.	Pitch (in.)
56351	35	4	3/8	66351	35	4	3/8
56352	35-2	4	3/8	66352	35-2	4	3/8
56411	41	4	1/2	66411	41	4	1/2
56401	40	4	1/2	66401	40	4	1/2
56501	50	4	5/8	66501	50	4	5/8
56502	50-2	4	5/8	66502	50-2	4	5/8
56601	60	3	3/4	66601	60	3	3/4
56602	60-2	3	3/4	66602	60-2	3	3/4
56603	60-H	3	3/4	66603	60-H	3	3/4
56801	80	2	1	66801	80	2	1
56802	80-2	2	1	66802	80-2	2	1
56803	80-H	2	1	66803	80-H	2	1
56100	100	2	1-1/4	66100	100	2	1-1/4
56120	120	2	1-1/2	66120	120	2	1-1/2
52040	A2040	4	1	62040	A2040	4	1
52050	A2050	3	1-1/4	62050	A2050	3	1-1/4
52060	A2060	3	1-1/4	62060	A2060	3	1-1/2

• Packaged in carded bags



Roller Chain Breakers

Part No.	Item	Fits
75050*	Breaker	#25 to #60 Chain
75051*	Breaker	#60 to #100 Chain
75053	Replacement tip assembly	75050 Breaker
75054	Replacement tip assembly	75051 Breaker

- Black oxide & zinc plated
- Tips made from tool steel
- *Packaged in resealable clamshell

Tractor Tool Boxes



Part No.	Package
75013	Tool Box Tractor Red Portable 16"
75014	Tool Box Mountable 16" Green
75015	Tool Box Tractor Black 20"

- Easy mounting to your tractor or equipment
- Hardware and brackets for universal mounting included

Stroke Controls



Part No.	Fits Shaft Sizes (in.)	Segment (in.)	Wgt. (lbs.)
70098	1-3/8 & 1-1/2	3/4, 1, 1-1/4, & 1-1/2	1.5
70099	1-1/8 & 1-1/4	3/4, 1, 1-1/4, & 1-1/2	1.5
79697	1-3/4, 1-7/8, & 2	1, 1-1/4, 2, & 4	3.9
79899	1-1/8, 1-1/4, 1-3/8, & 1-1/2	3/4, 1, 1-1/4, & 1-1/2	1.8

- Aluminum

Rain Caps



Part No.	Size (in.)	Min. Exhaust O.D. (in.)	Max. Exhaust O.D. (in.)
71032	1-1/4	1-1/4	1-7/16
71033	1-1/2	1-1/2	1-11/16
71034	1-3/4	1-3/4	1-15/16
71035	2	2	2-3/16
71036	2-1/4	2-1/4	2-7/16
71037	2-1/2	2-1/2	2-11/16
71038	2-3/4	2-3/4	2-15/16
71039	3	3	3-3/16
71041	3-1/2	3-1/2	3-11/16
71042	3-3/4	3-3/4	3-15/16
71043	4	4	4-3/16
71044	5	5	5-3/16

- Automatic exhaust pipe protection
- Keeps out moisture when engine is off
- Protective grey powder coating
- Each cap permanently marked with size
- Complete range of sizes

Set Collars

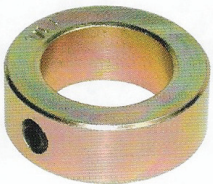

Part No.	Bore Size (in.)	Outside Dia. (in.)	Width (in.)	Pkg. No.	Pkg. Type	Pcs/ Pkg.	Pkg. Wgt. (lbs.)
70360	3/8	3/4	3/8	82360	B	2	0.6
70361	1/2	1	1/2	82361	B	2	1.2
70362	5/8	1-1/8	9/16	82362	B	2	1.9
70363	3/4	1-3/8	5/8	82363	B	2	2.9
70364	7/8	1-1/2	5/8	82364	B	2	0.8
70365	1	1-5/8	5/8	82365	B	2	1.3
70366	1-1/8	1-3/4	5/8	82366	B	1	1.9
70367	1-1/4	2	11/16	82367	B	1	5.7
70368	1-3/8	2-1/8	3/4	82368	B	1	6.7

- Machine sized for exact fit
- Allen head set screw

Package Type "B" Bagged • Package Type "C" Clamshell

Post Drivers



75523



75521

Part No.	Description	Length (in.)	O.D. (in.)	I.D. (in.)	Wgt. (lbs.)
75520	Post Driver	29-1/2	2-3/8	2-1/16	12
75521	Post Driver - Heavy-duty	23-3/8	3	2-3/4	16
75523	Post Driver - Heavy-duty	24	3	2-3/4	13.5

- Helps drive steel posts into the ground
- Easy grip handles

Sprockets



Part No.	Sprockets For #40 Chain	Part No.	Sprockets For #50 Chain	Part No.	Sprockets For #60 Chain
75300	Sprocket #40 Chain V-Hub 12 T	75319	Sprocket #50 Chain W-Hub 15 T	75326	Sprocket #60 Chain W-Hub 12 T
75301	Sprocket #40 Chain V-Hub 13 T	75321	Sprocket #50 Chain X-Hub 17 T	75328	Sprocket #60 Chain X-Hub 15 T
75302	Sprocket #40 Chain V-Hub 14 T	75322	Sprocket #50 Chain X-Hub 18 T	75329	Sprocket #60 Chain X-Hub 18 T
75303	Sprocket #40 Chain V-Hub 15 T	75323	Sprocket #50 Chain X-Hub 22 T		
75304	Sprocket #40 Chain W-Hub 16 T	75325	Sprocket #50 Chain X-Hub 36 T		
75306	Sprocket #40 Chain W-Hub 18 T				
75308	Sprocket #40 Chain X-Hub 20 T				
75312	Sprocket #40 Chain X-Hub 32 T				
75314	Sprocket #40 Chain X-Hub 40 T				
75315	Sprocket #40 Chain X-Hub 48 T				

- #40, #50, and #60 plate sprockets feature a flat, hubless design for easy drilling and custom mounting to your equipment

Hubs



Part No.	Weld-On Hubs V-Series	Part No.	Weld-On Hubs W-Series	Part No.	Weld-On Hubs X-Series
75331	Hub 1/2" V-Hub	75335	Hub 1/2" W-Hub	75343	Hub 3/4" X-Hub
75332	Hub 5/8" V-Hub	75336	Hub 5/8" W-Hub	75345	Hub 1" X-Hub
75333	Hub 3/4" V-Hub	75337	Hub 3/4" W-Hub	75346	Hub 1-1/8" X-Hub
75334	Hub 7/8" V-Hub	75338	Hub 7/8" W-Hub	75347	Hub 1-1/4" X-Hub
		75339	Hub 1" W-Hub	75348	Hub 1-3/8" X-Hub
		75340	Hub 1-1/8" W-Hub	75350	Hub 1-1/2" X-Hub
		75341	Hub 1-1/4" W-Hub		

Idlers



Part No.	Flat Idler Puller	Part No.	Idler Sprockets
75369	Pulley Idler 4" OD 1/2" Bore	75351	Sprocket Idler #40 17 T 1/2" Bore
75370	Pulley Idler 4" OD 5/8" Bore	75352	Sprocket Idler # 40 17 T 8/8" Bore
		75353	Sprocket Idler #50 15 T 1/2" Bore
		75354	Sprocket Idler #50 15 T 5/8" Bore
		75355	Sprocket Idler #60 13 T 5/8" Bore

- Engineered high-quality Flat Idler Pulleys and Sprockets built for dependable farm and agricultural performance

Pulleys



Part No.	Pulleys For A, B, and C Belts
75356	Pulley 2-1/2" V-Hub
75357	Pulley 3" V-Hub
75358	Pulley 3-1/2" W-Hub
75359	Pulley 4" W-Hub
75360	Pulley 5" W-Hub
75361	Pulley 6" W-Hub
75362	Pulley 6-1/2" W-Hub
75363	Pulley 7" W-Hub
75364	Pulley 8" W-Hub
75365	Pulley 10" W-Hub
75366	Pulley 12" W-Hub
75367	Pulley 14" W-Hub
75368	Pulley 16" W-Hub

- Precision-engineered A, B, and C belt pulleys to keep your agricultural and outdoor equipment running strong

Merchandising Program

Category-coded clamshell packaging



Agralink™ offers a simple to understand merchandising program that benefits your customers, your sales efforts and your brand. At the end of the day, next generation point of sale systems should allow you to increase the category product turns as it also becomes a more efficient marketing tool for you. This well implemented POS system from Agralink will result in reduced marketing expenditures and increase sales volume.

Point-of-Sale product identification hangtags



The use of effective signage on this display attracts attention, engages your consumer, and offers distinct advantages over the standard 3-point tractor linkage product displays. It engages the customer by presenting the product at eye level and in multiple compartments. And finally, our point of sale display set will act like an extra sales person in your store. It offers a distinct advantage or value proposition by including both copy and visuals explaining what the product is and where it's used.

Point-of-Sale informative headers

agra link™ | Tractor 3-Point Hitch Parts

Typical Parts Used on a 3-Point Hitch Assembly

- 1 Top Link Pin
- 2 Top Link
- 3 Upper Stay Strap
- 4 Lift Arm Levelling Assembly
- 5 Stabilizer Bracket
- 6 Check Chain Eye Bolt
- 7 Lift Arm
- 8 Adjustable Stabilizer Arm
- 9 Stabilizer Chain
- 10 Check Chain Clevis
- 11 Power-Take-Off PTO
- 12 Swinging Drawbar Hanger
- 13 Swinging Drawbar
- 14 Drawbar
- 15 Lower Stay Strap
- 16 Lynch Pin
- 17 Draw Pin

agra link™ | Tractor 3-Point Categories

Maximum Drawbar Horsepower	Top Link Pin Diameter	Pull or Draw Pin Diameter	Standard Lift Arm Spacing
Cat. 0 - up to 20	5/8"	5/8"	20"
Cat. 1 - up to 45	3/4"	7/8"	26"
Cat. 2 - 40 to 100	1"	1-1/8"	32"
Cat. 3 - 80 to 225	1-1/4"	1-7/16"	38"

agra link™ | Tractor 3-Point Linkage Parts

Top Link Connection

Lift Arm Connection

Contact your Agralink sales representative at 800-821-9542 for more details.



agraTronix™

1790 Miller Parkway
Streetsboro, Ohio 44241 USA
p: 330-562-2222 • f: 330-562-7403

800-821-9542 | www.agratronix.com



Supplied by:



Our Strength Lies in Our Roots.