



WARNING

Protective clothing and equipment should always be worn when using this product.



WARNING

Please keep the product and all parts away from children before full assembly has been completed by a responsible adult. Unassembled product contains small parts and potentially harmful sharp edges.

VII. Dimensions of Entire Tricycle

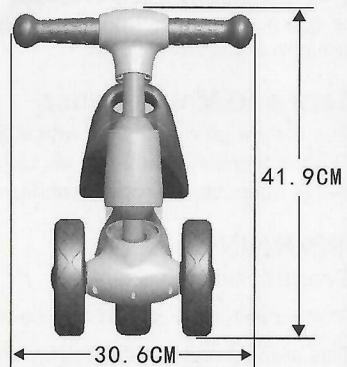
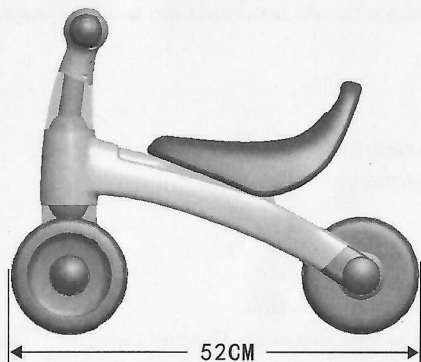

Mini Racer Trike

Read Operation Instructions Carefully Before Use



Please read the installation instructions carefully before installation

Assembly Help/Tech Support/Missing Parts

BEST RIDE ON CARS

11937 Denton Dr

Suite # 101

Dallas, TX 75234

Ph:1-888-411-1786

K07-SMS-136-018

018-02

Contents







- I. Product Specifications and Parameters
- II. Components List
- III. Assembly Diagram
- IV. Function and Operation
- V. Care and Maintenance
- VI. WARNING
- VII. Dimensions of entire car

MADE IN CHINA

I. Product Specifications and Parameters

- This product is suitable for the children of 2-4 years old, and shall be used under adult supervision!
- Product dimensions: 52 × 30.6 × 41.9 CM
- Product maximum load weight: 23 kg
- Product operating ambient temperature: 0-40 °C

II. Components List

1. Car Body 	4. Seat 	7. Screw 5×45PM 
2. Car front directive wheel 	5. Grip rubber sleeve 2PCS 	
3. Handlebar 	6. Seat screw 4×43BAB(D=7.5) 	

III. Assembly Diagram

1. Installation of seat

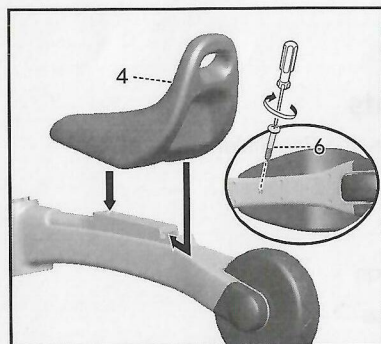

Install the seat (part 4) in the specified position (as shown by the arrow in the figure) of the vehicle body, tightly press it in place, turn over the vehicle body, and then tighten the seat screw (part 6).

2. Install grip and steering wheel

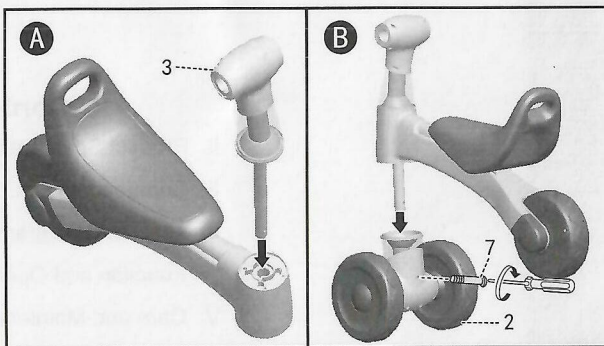

A Install the grip (part 3) in the specified position of the vehicle body. **B** Then, install steering wheel (part 2) in the specified position of the vehicle body as shown in the figure, align the position of each hole before installation and then tighten it with screws (part 7).

3. Install grip rubber sleeve.

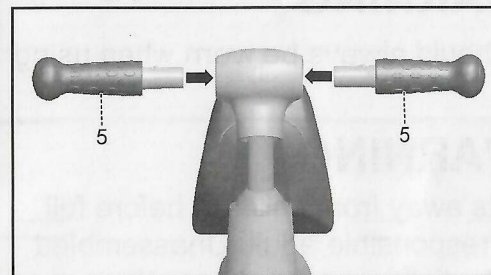

Insert grip rubber sleeve (part 5) into specified positions at two sides and then clamp it tightly.

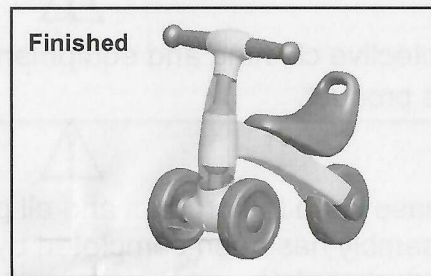

IV. Function and Operation

My little friend, you can sit on the sliding car, tightly hold the handle with both hands and pedal backwards with both feet to sliding freely.

V. Care and Maintenance

- 1) Regularly wipe and clean it with a piece of cloth.
- 2) The rotating parts of the car should be checked regularly to determine whether any foreign matter obstructs the rotation and to keep lubricating state of normal operation.

VI. WARNING

1. Product warning

- 1) Product assembly should only be undertaken by a responsible adult.
- 2) This product must be thoroughly checked for safety before allowing a child to use it.
- 3) It is recommended that children always wear shoes and other protective clothing and equipment (e.g. helmet, gloves, kneepads etc.) during use.
- 4) This product must only be used on a flat level surface. Do not use it on a public road or near dangerous areas such as steps, uneven ground, water etc.
- 5) This car must only be used by a single child, maximum load 23kg.
- 6) Small parts possibly fall off when this product is used improperly. So, it is unsuitable for children under 2 years old.
- 7) The product packaging is not a toy and must be kept away from children. To avoid suffocation, remove all packaging material after product assembly.
- 8) These instructions contain important information, please retain them after product assembly.

2. WARNING



WARNING

To reduce the risk of injury, adult supervision is required at all times. In the interests of safety, **DO NOT** use this product on public roads, near motor vehicles, uneven ground, swimming pools or where there is water.

Product must only be used by one child at a time.