



**Gardening
Made Easier.
Anytime,
Anywhere.**

Contact Us

 +1 (866) 597-1888

 Vegö Garden Academy

 hello@vegogarden.com

 vegogarden.com

 vego_garden

 Houston, TX



General Manual for Woodgrain Metal Raised Garden Bed - Evergrove Series

Gardening Made Easier. Anytime, Anywhere.







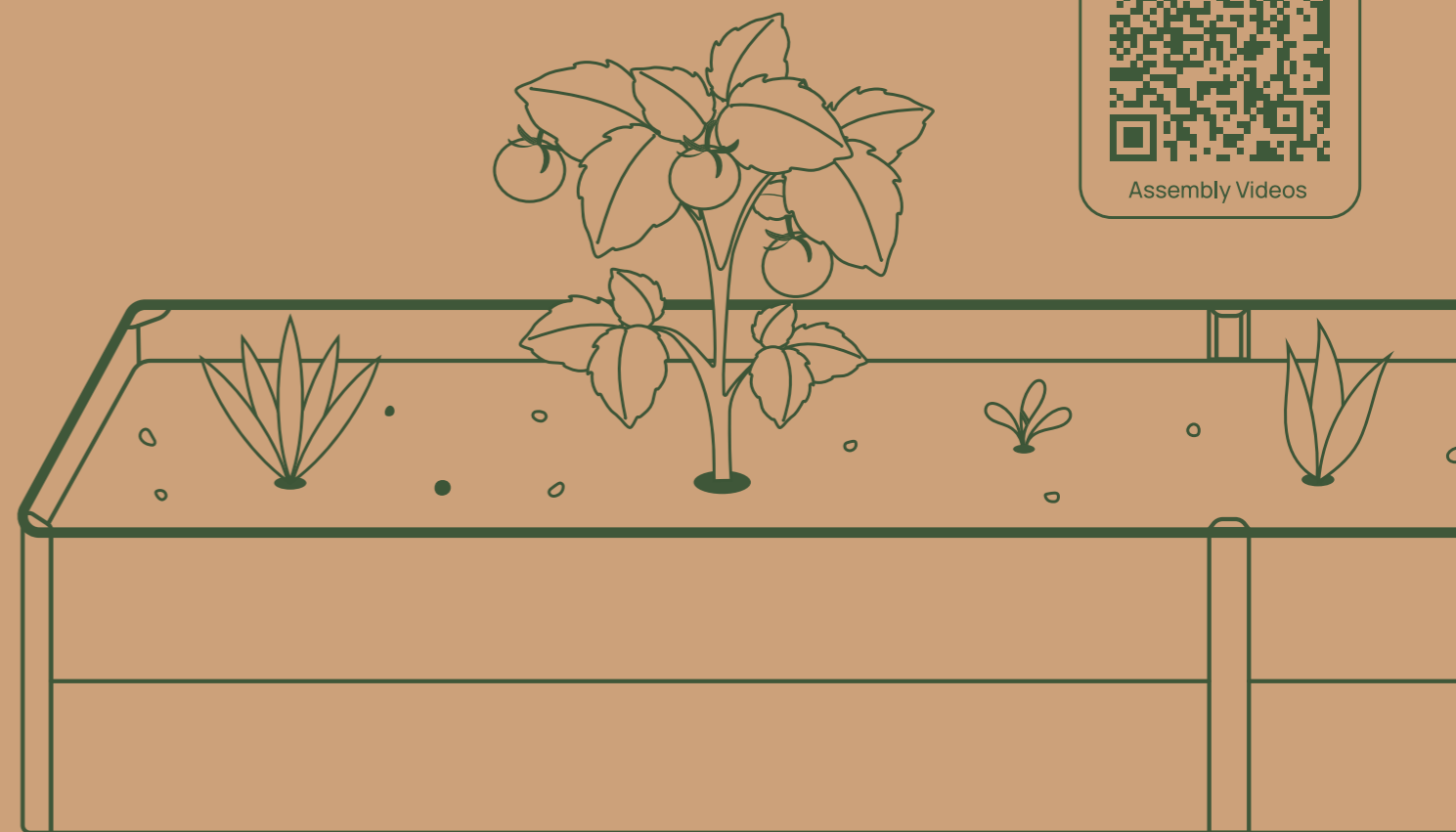

Copyright © 2025 Vegö

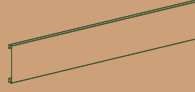

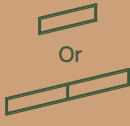
Assembly Videos

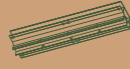
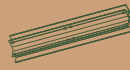

Parts List

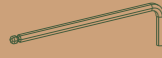
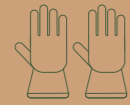
Configuration \ Part Name	4ft x 8ft	4ft x 4ft	2ft x 8ft
4ft Metal Slat 	12	8	8
2ft Metal Slat 			4
Bracing Frame  Or 	1		1
In-line Connector 	2		2
Corner Post 	4	4	4
S1 Aluminum Cap 	4	4	4
S2 Aluminum Cap 	2		2
F2 Bolt 	52	32	52
Wrench 	1	1	1
Glove 	1	1	1

Safety Precautions

This product may contain sharp metal corners and edges. To prevent injury:

- Handle with care at all times
- Wear gloves, closed-toe shoes & long pants when handling
- Work on a stable, clean surface away from children and pets
- Follow all instructions carefully and use tools only as directed

If you are unsure about any step, pause and seek assistance.



Assembly Tips

- Additional tools are needed to complete this assembly, see below:



- During assembly, we recommend placing the unpacked box flat on the ground to serve as a protective mat.

Assembly Guide

www.vegogarden.com/assembly

- 1 To safeguard the product's surface during transportation, a protective film is applied to the exterior of each slat. Please remove the film before assembly.

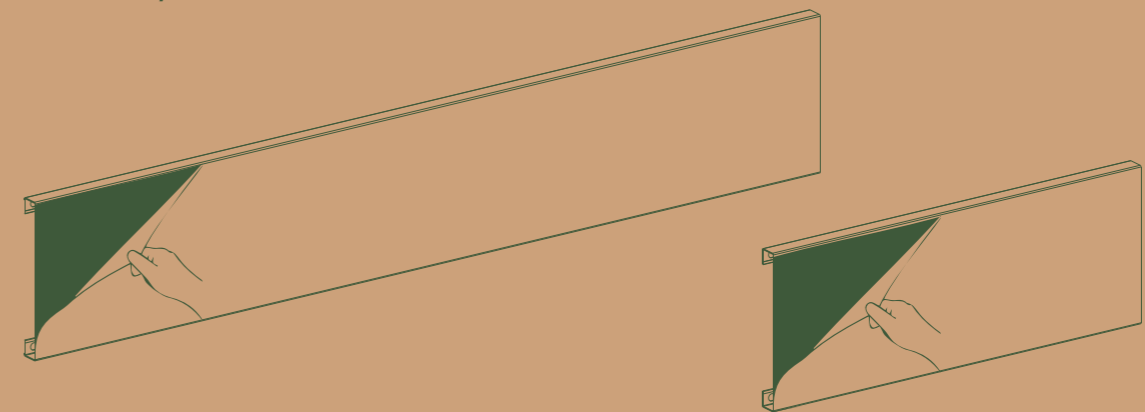

- 2** Start assembling the Evergrove Garden Bed from any corner. First, insert the metal slat into the corner post from the side, aligning the holes on the metal slat with those on the corner post.

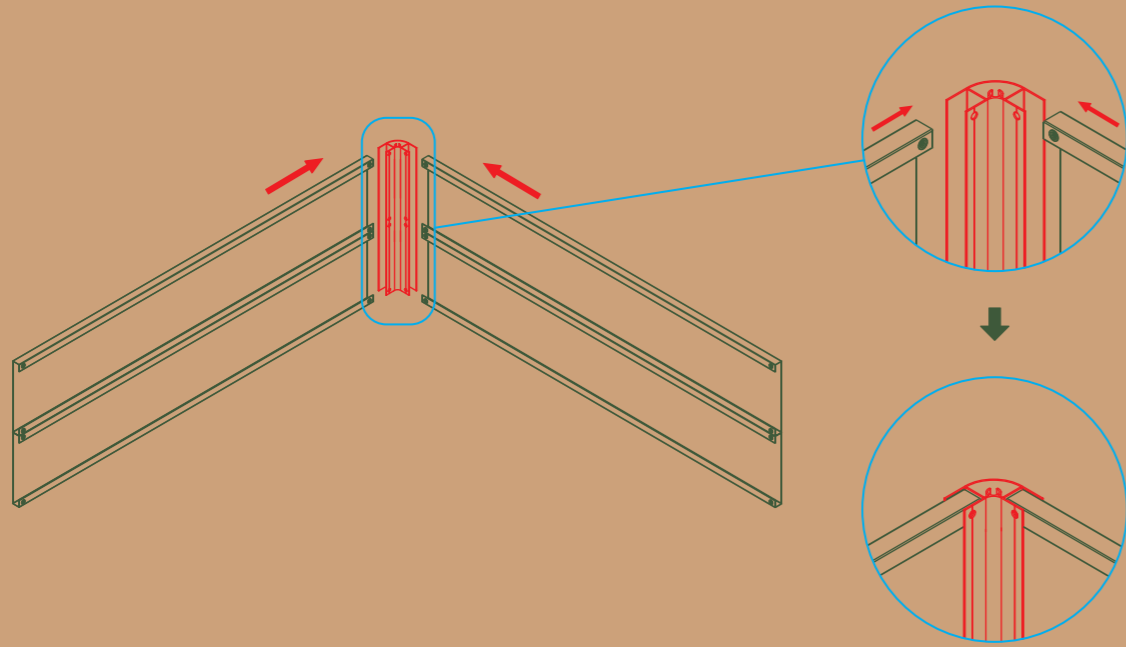

Then, secure them using F2 bolts and wrench. Each corner post and metal slat connection has a total of eight holes that need to be tightened.

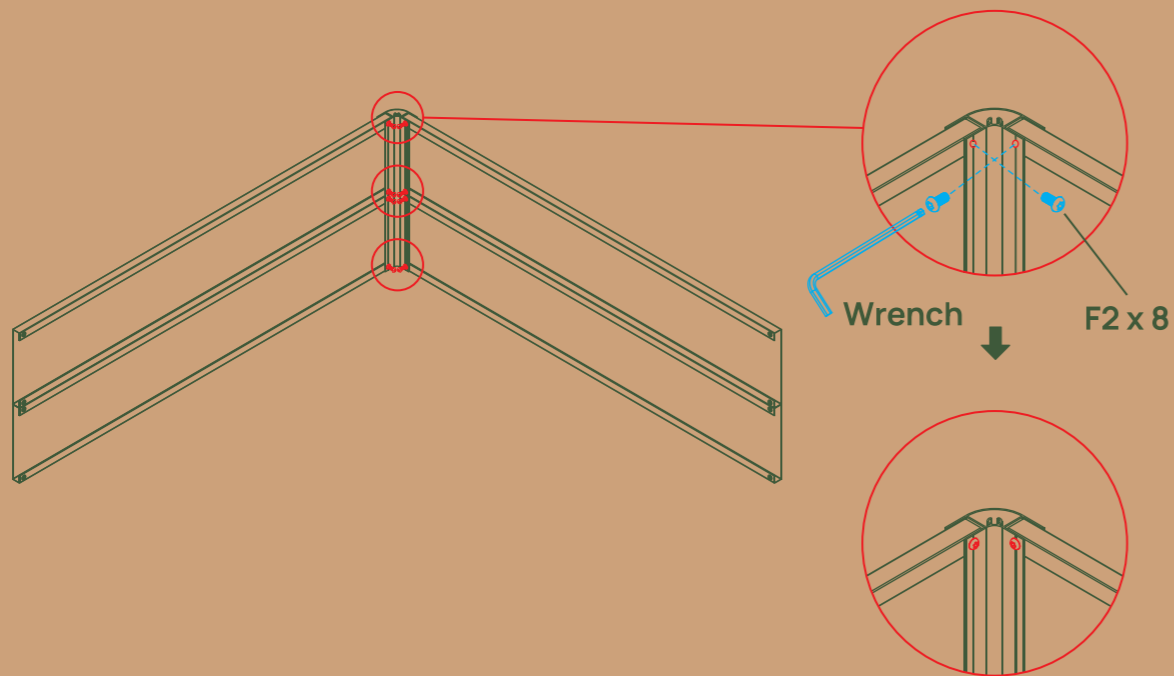

- 3** For the 4ft x 8ft and 2ft x 8ft rectangular garden beds, use the in-line connectors to assemble the long sides. Insert the in-line connectors and metal slats from the side, then secure them tightly using the F2 bolts and Wrench.

For the 4ft x 4ft Garden Bed, skip this step and move on to Step 4.

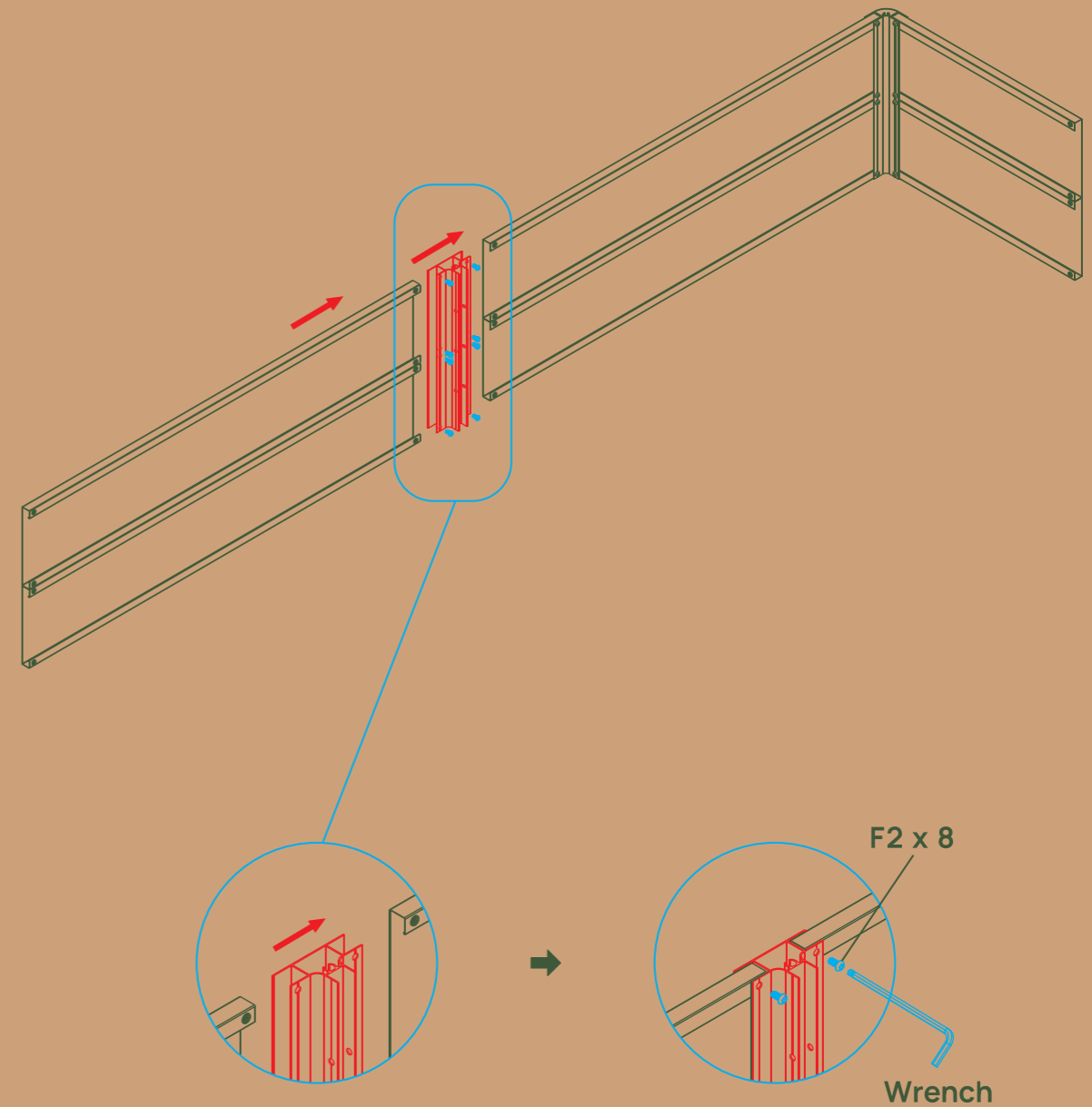

4 Repeat Step 2 and Step 3 to complete the assembly of all four sides of the Garden Bed.

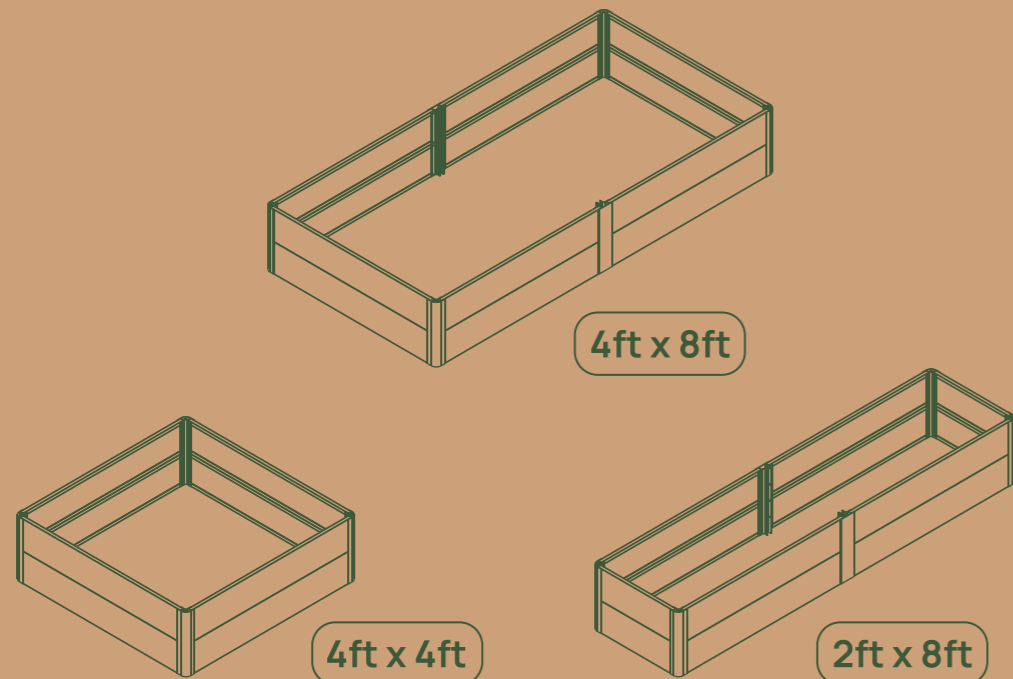

5 Assemble the Bracing Frame onto the Garden Bed.

For the 4ft x 4ft Garden Bed, no bracing frame is required.
For 4ft x 8ft and 2ft x 8ft garden beds, use the F2 bolts to attach the bracing frame to the two holes at the bottom of the in-line connector.

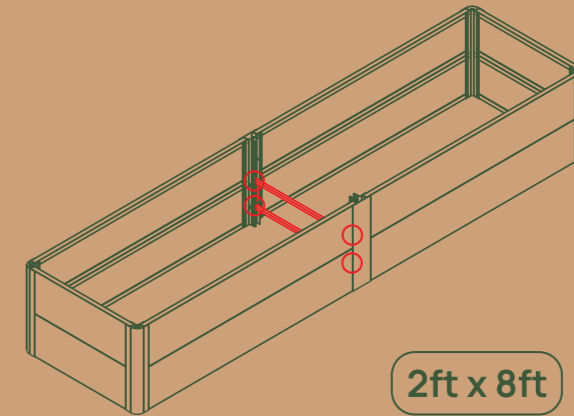
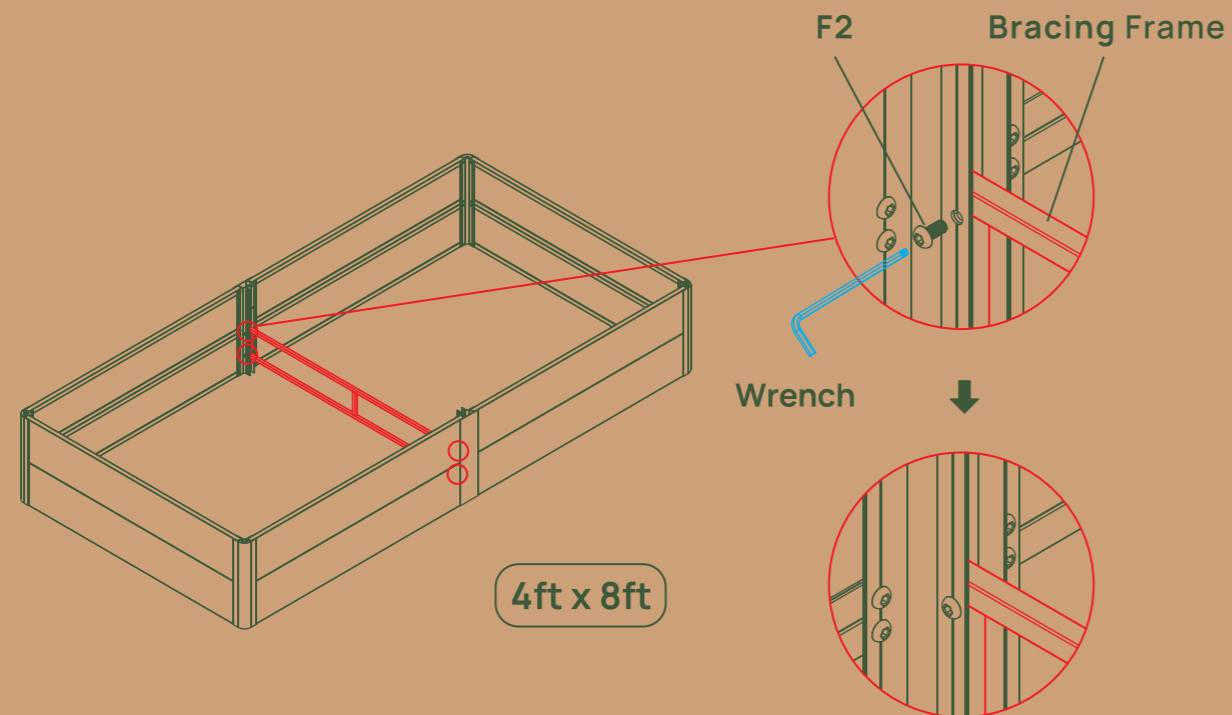

6 Insert S1/S2 into the corner post and in-line connector, then tap them down gently with a rubber hammer.

