

OSAKAPR

CHAIN SAW **58CC**

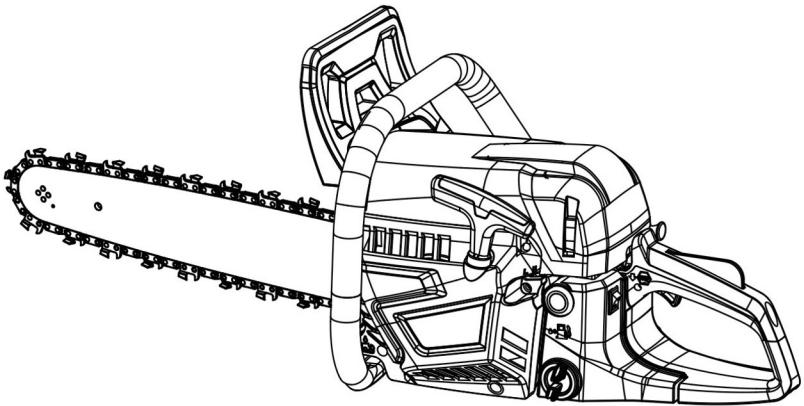

ATTENTION:

1. Please check the manual carefully and make sure you have received all the parts.
2. If there is any missing, please let us know the letter of the parts you need.
3. If there is any damage, please send clear photos to us, we will check and offer you best solution soon.

Contents

1. For Safe Operation-----1
 2. Explanation of Symbols on the Machine-----4
 3. Installing Guide Bar and Saw Chain-----5
 4. Fuel and Chain Oil-----6
 5. Operating the Engine-----8
 6. Sawing-----11
 7. Maintenance-----13
 8. Maintenance of Saw Chain and Guide Bar-----15
 9. Troubleshooting Guide-----16
 10. Specifications-----17

Dear Customer,





Firstly, we wish to thank you for having chosen our products and hope that the use of this machine will be extremely satisfying for you and fully meet your expectations. This manual has been drawn up to allow you to get to know your machine well and use it in safe and efficient conditions; please do not forget that it is an integral part of the machine and keep it to hand to be consulted at all times and consign it with the machine if you should sell or lend it to others.

Your new machine has been designed and manufactured to current standards and is safe and reliable if used in full respect of the instructions contained in this manual (forecast use); any other use or failure to comply with the instructions for safe use, maintenance and repair shall be considered as "improper use", cause the warranty to become null and void and relieve the Manufacturer from all responsibility, with the user becoming responsible for charges for damages or personal or third party injury.

If any slight differences are found between the description herein and the machine you own, please bear in mind that due to continual product improvement, the information contained in this manual is subject to modification without prior notice or obligatory updating although the essential features for the purposes of safety and operation remain unchanged. In the event of doubt, please contact your dealer. Enjoy your work!

1. For Safe Operation

EXPLANATION OF SYMBOLS AND SAFETY WARNINGS

-  Read operator's instruction book before operating this machine.
-  Use the chain saw with two hands.
-  Read, understand and follow all warnings.
-  Wear head, eye and ear protection.
-  Warning! Danger of kickback.



WARNING!!!



RISK OF DAMAGING HEARING

IN NORMAL CONDITIONS OF USE,
 THIS MACHINE MAY INVOLVE A DAILY
 LEVEL OF PERSONAL EXPOSURE TO
 NOISE FOR THE OPERATOR EQUAL
 TO OR GREATER THAN
 85 dB(A)

1. For Safe Operation



1. Never operate a chain saw when you are fatigued, ill, or upset, or under the influence of medication that may make you drowsy, or if you are under the influence of alcohol or drugs.



8. Do not allow other persons to be near the chain saw when starting or cutting. Keep bystanders and animals out of the work area. Children, pets and bystanders should be a minimum of 10 m away when you start or operate the chain saw.



2. Use safety footwear, snug fitting clothing and eye, hearing and head protection devices. Use the vibration-proof glove.



9. Never start cutting until you have a clear work area, secure footing, and a planned retreat path from the falling tree.

3. Keep the saw chain sharp and the saw, including the AV system, well maintained. A dull chain will increase cutting time, and pressing a dull chain through wood will increase the vibrations transmitted to your hands. A saw with loose components or with damaged or worn AV buffers will also tend to have higher vibration levels.



10. Always hold the chain saw firmly with both hands when the engine is running. Use a firm grip with thumb and fingers encircling the chain saw handles.

4. All the above mentioned precautions do not guarantee that you will not sustain whitefinger disease or carpal tunnel syndrome. Therefore, continual and regular users should monitor closely the condition of their hands and fingers. If any of the above symptoms appear, seek medical advice immediately.



11. Keep all parts of your body away from the saw chain when the engine is running.



12. Before you start the engine, make sure the saw chain is not contacting anything.



13. Always carry the chain saw with the engine stopped, the guide bar and saw chain to the rear, and the muffler away from your body.



5. Always use caution when handling fuel. Wipe up all spills and then move the chain saw at least 3 m from the fueling point before starting the engine.



14. Always carry the chain saw with the engine stopped, the guide bar and saw chain to the rear, and the muffler away from your body.

6. Eliminate all sources of sparks or flame (i.e. smoking, open flames, or work that can cause sparks) in the areas where fuel is mixed, poured, or stored.



15. All chain saw service, other than the items listed in the Owner's Manual, should be performed by competent chain saw service personnel. (E.g., if improper tools are used to remove the flywheel, or if an improper tool is used to hold the flywheel in order to remove the clutch, structural



7. Do not smoke while handling fuel or while operating the chain saw.





damage to the flywheel could occur which could subsequently cause the flywheel to disintegrate.)

16. Always shut off the engine before setting it down.



17. Use extreme caution when cutting small size brush and saplings because slender material may catch the saw chain and be whipped toward you or pull you off balance.

18. When cutting a limb that is under tension, be alert for springback so that you will not be struck when the tension in the wood fibers is released.



19. Never cut in high wind, bad weather, when visibility is poor or in very high or low temperatures. Always check the tree for dead branches which could fall during the felling operation.

20. Keep the handles dry clean and free of oil or fuel mixture.



21. Operate the chain saw only in well ventilated areas. Never start or run the engine inside a closed room or building. Exhaust fumes contain dangerous carbon monoxide.



22. Do not operate the chain saw in a tree unless specially trained to do so.



23. Guard against kickback. Kickback is the upward motion of the guide bar which occurs when the saw chain at the nose of the guide bar contacts an object. Kickback can lead to dangerous loss of control of the chain saw.

24. When transporting your chain saw, make sure the appropriate guide bar scabbard is in place.

KICKBACK SAFETY PRECAUTIONS FOR CHAIN SAW USERS

⚠ WARNING!

Kickback may occur when the nose or tip of the guide bar touches an object, or when the wood closes in and pinches the saw chain in the cut. Tip contact in some cases may cause a lightning fast reverse reaction, kicking the guide bar up and back towards the operator.



Pinching the saw chain along the top of the guide bar may push the guide bar rapidly back towards the operator. Either of these reactions may cause you to lose control of the saw, which could result in serious personal injury.

Do not rely exclusively on the safety devices built into your saw. As a chain saw user you should take several steps to keep cutting jobs free from accident or injury.

1. With a basic understanding of kickback you can reduce or eliminate the element of surprise. Sudden surprise contributes to accidents.



2. Keep a good grip on the saw with both hands, the right hand on the rear handle, and the left hand on the front handle, when the engine is running. Use a firm grip with thumbs and fingers encircling the chain saw handles. A firm grip will help you reduce kickback and maintain control of the saw.



3. Make certain that the area in which you are cutting is free from obstructions. Do not let the nose of the guide bar contact a log, branch, or any other obstruction which could be hit while you are operating the saw.



4. Cut at high engine speeds.

5. Do not overreach or cut above shoulder height.



6. Follow the manufacturer's sharpening and maintenance instructions for the saw chain.

7. Only use replacement bars and chains specified by the manufacturer or the equivalent.

2. Explanation of Symbols on the Machine

⚠ WARNING! For safe operation and maintenance, symbols are carved in relief on the machine. According to these indications, please be careful not to make any mistake.



The port to refuel "MIX GASOLINE"
Position: Fuel cap



The port to top up chain oil
Position: Oil cap



Setting the switch to the "I" position, the engine starts. Setting the switch to the "O" position, the engine stops immediately.
Position: Front at the top of the rear handle



Starting the engine. If you pull out the choke knob (at the back-right of the rear handle) to the point of the arrow, you can set the starting mode as follows:
First-stage position - starting mode when the engine is warm.
Second-stage position - starting mode when the engine is cold.
Position: Upper-right of the aircleaner cover

H

The screw under the "H" stamp is The High-speed adjustment screw.

L

The screw under the "L" stamp is The Slow-speed adjustment screw.

T

The screw at the left of the "T" stamp is the Idle adjustment screw.
Position: Left side of the rear handle

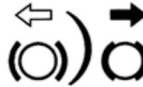

Shows the directions that the chain brake is released (white arrow) and activated (black arrow).
Position: Front of the chain cover



If you turn the rod by screwdriver follow the arrow to the 'MAX' position, the chain oil flow more, and if you turn to the 'MIN' position, less.
Position: Bottom of the power unit

3. Installing Guide Bar and Saw Chain

A standard saw unit package contains the items as illustrated.

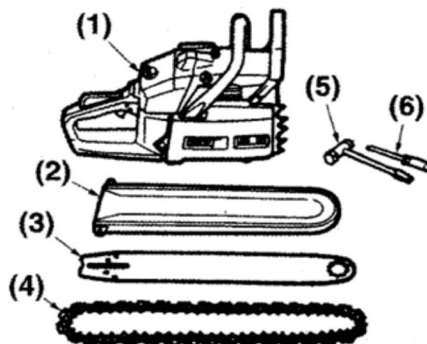

- (1) Power unit
- (2) Bar protector
- (3) Guide bar
- (4) Saw chain
- (5) Plug wrench
- (6) Screwdriver for carburetor adjustment

Open the box and install the guide bar and the saw chain on the power unit as follows:

⚠ WARNING! The saw chain has very sharp edges. Use thick protective gloves for safety.

1. Pull the guard towards the front handle to check that the chain brake is not engaged.
2. Loosen the nuts and remove the chain cover.

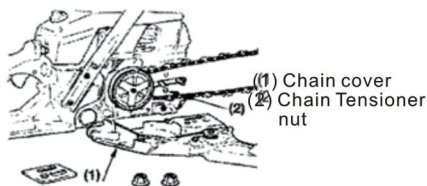

3. Gear the chain to the sprocket and, while fitting the saw chain around the guide bar, mount the guide bar to the power unit. Adjust the position of chain tensioner nut

NOTE

Pay attention to the correct direction of the saw chain.



4. Fit the chain cover to the power unit and fasten the nuts to finger tightness.
5. While holding up the tip of the bar, adjust the chain tension by turning the tensioner screw until the tie straps just touch the bottom side of the bar rail.
6. Tighten the nuts securely with the bar tip held up (12 - 15 Nm). Then check the chain for smooth rotation and proper tension while moving it by hand. If necessary, readjust with the chain cover loose.
7. Tighten the tensioner screw.

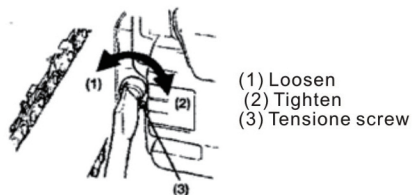

NOTE

A new chain will expand its length in the beginning of use. Check and readjust the tension frequently as a loose chain can easily derail or cause rapid wear of itself and the guide bar.

4. Fuel and Chain Oil

•FUEL

⚠ WARNING! Gasoline is very flammable. Avoid smoking or bringing any flame or sparks near fuel.

Make sure to stop the engine and allow it cool before refueling the unit.

Select outdoor bare ground for fueling and move at least 3 m (10 ft) away from the fueling point before starting the engine.



- The engines are lubricated by oil specially formulated for air-cooled 2-cycle gasoline engine use. Use an anti-oxidant added quality oil expressly labeled for air-cooled 2-cycle engine use (JASO FC GRADE OIL or ISO EGC GRADE)
- Do not use BIA or TCW (2-stroke water-cooling type) mixed oil.



•RECOMMENDED MIXING RATIO GASOLINE 50:OIL 1

- Exhaust emission are controlled by the fundamental engine parameters and components (eq., carburation, ignition timing and port timing) without addition of any major hardware or the introduction of an inert material during combustion.
- These engines are certified to operate on unleaded gasoline.

Make sure to use gasoline with a minimum octane number of 89RON (USA/Canada: 87AL).

- If you use a gasoline of a lower octane value

than prescribed, there is a danger that the engine temperature may rise and an engine problem such as piston seizing may consequently occur.

- Unleaded gasoline is recommended to reduce the contamination of the air for the sake of your health and the environment.
- Poor quality gasolines or oils may damage sealing rings, fuel lines or fuel tank of the engine.

•HOW TO MIX FUEL

⚠ WARNING! Pay attention to agitation.

1. Measure out the quantities of gasoline and oil to be mixed.
2. Put some of the gasoline into a clean, approved fuel container.
3. Pour in all of the oil and agitate well.
4. Pour in the rest of gasoline and agitate again for at least one minute. As some oils may be difficult to agitate depending on oil ingredients, sufficient agitation is necessary for the engine to last long. Be careful that, if the agitation is insufficient, there is an increased danger of early piston seizing due to abnormally lean mixture.
5. Put a clear indication on the outside of the container to avoid mixing up with gasoline or other containers.
6. Indicate the contents on outside of container for easy identification.

•FUELING THE UNIT

1. Untwist and remove the fuel cap. Rest the cap on a dustless place.
2. Put fuel into the fuel tank to 80% of the full capacity.
3. Fasten the fuel cap securely and wipe up any fuel spillage around the unit.

⚠ WARNING!

1. Select flat and bare ground for fueling.
2. Move at least 10 feet (3 meters) away from the fueling point before starting the engine.
3. Stop the engine before refueling the unit. At that time, be sure to sufficiently agitate the mixed gasoline in the container.

•FOR YOUR ENGINE LIFE, AVOID:

1. FUEL WITH NO OIL (RAW GASOLINE) - It will cause severe damage to the internal engine parts very quickly.
2. GASOHOL - It can cause deterioration of rubber and/or plastic parts and disruption of engine lubrication.
3. OIL FOR 4-CYCLE ENGINE USE - It can cause spark plug fouling, exhaust port blocking, or piston ring sticking.
4. Mixed fuels which have been left unused for a period of one month or more may clog the carburetor and result in the engine failing to operate properly.
5. In the case of storing the product for a long period of time, clean the fuel tank after rendering it empty. Next, activate the engine and empty the carburetor of the composite fuel.
6. In the case of scrapping the used mixed oil container, scrap it only at an authorized repository site.

Moreover, normal wear and change in product with no functional influence are not covered by the warranty. Also, be careful that, if the usage in the instruction manual is not observed as to the mixed gasoline, etc. described therein, it may not be covered by the warranty.

•CHAIN OIL

Use motor oil SAE #10W-30 all year round or SAE 30~ #40 in summer and SAE #20 in winter.

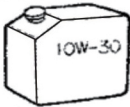
**NOTE**

Do not use wasted or regenerated oil that can cause damage to the oil pump.

5. Operating the Engine

⚠ WARNING! It is very dangerous to run a chainsaw that mounts broken parts or lacks any parts. Before starting engine, make sure that all the parts including bar and chain are installed properly.

• STARTING THE ENGINE

1. Fill fuel and chain oil tanks respectively, and tighten the caps securely.



(1) Chain oil
(2) Fuel

2. Set the switch to "I" position.

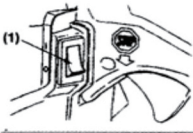

(1) Switch
(2) Throttle lever
(3) Throttle interlock

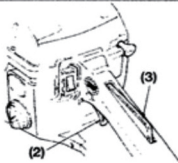

3. While holding the throttle lever together with the trigger safety, push in the side latch and release the throttle lever to leave it at the starting position.

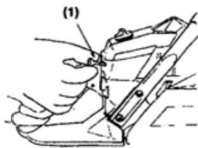

(1) Choke knob:
(a) When the engine is cool
(b) When the engine is warm up
(c) After the engine starts

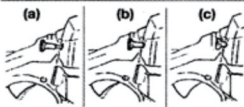

NOTE

When restarting immediately after stopping the engine, set the Choke knob in the first-stage position (choke open and throttle lever in the starting position).

NOTE

Once the choke knob has been pulled out, it will not return to the operating position even if you press down on it with your finger. When you wish to return the choke knob to the operating position, pull out the throttle lever instead.

4. If your machine has a primer (3), press it 3-4 times to aid starting.
5. While holding the saw unit securely on the ground, pull the starter rope vigorously.

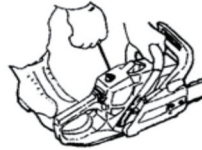

⚠ WARNING!

Do not start the engine while the Chain saw hangs in one hand. The saw chain may touch your body. THIS is very dangerous.

6. When engine has ignited, first push in the choke knob to the first-stage position and then pull the starter again to start the engine.
7. Allow the engine to warm up with the throttle lever pulled slightly.

⚠ WARNING!

Keep clear of the saw chain as it will start rotating upon starting of engine.

• CHECKING THE OIL SUPPLY

⚠ WARNING!

Make sure to set up the bar and the chain when checking the oil supply. If not, the rotating parts may be exposed. It is very dangerous.

After starting the engine, run the chain at medium speed and see if chain oil is scattered off as shown in the figure.



(1) Chain oil

The chain oil flow can be changed by inserting a screwdriver in the hole on bottom of the clutch side. Adjust according to your work conditions.

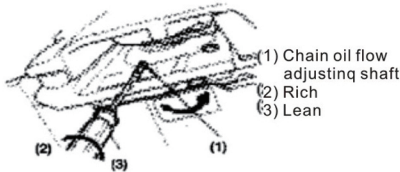

NOTE

The oil tank should become nearly empty by the time fuel is used up. Be sure to refill the oil tank every time when refueling the saw.

• ADJUSTING THE CARBURETOR

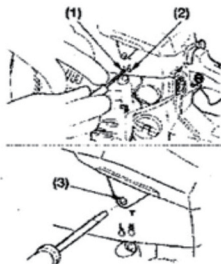

(1) "1" needle
(2) "H" needle
(3) Idle adjusting screw

The carburetor has been adjusted at the factory. Should your unit need readjustment due to the changes in altitude or operating conditions, please let your skillful dealer make the adjustment.

A wrong adjustment may cause damage to your unit.

If you have to make the adjustment yourself, please follow the procedure below carefully.

Before adjusting the carburetor, make sure that the provided air/fuel filters are clean and fresh and the fuel, properly mixed.

When adjusting, take the following steps:

NOTE

Be sure to adjust the carburetor with the bar chain attached.

- "H" and "L" needles are restricted within the number of turn as shown below.
"H" needle: -1/4
"L" needle: -1/4
- Start the engine and allow it to warm up in low speed for a few minutes.
- Turn the idle adjusting screw (T) counterclockwise so that the saw chain does not turn. If the idling speed is too slow, turn the screw clockwise.
- Make a test cut and adjust the "H" needle for best cutting power, not for maximum speed.

NOTE

Over revolution of "H" needle causes a lack of power or a poor acceleration. In such a case please turn the "H" needle a little counterclockwise.

• CHAIN BRAKE

This machine is equipped with an automatic brake (stop) saw chain rotation upon occurrence of kickback during saw cutting.

The brake is automatically operated by inertial force, which acts on the weight fitted inside the front guard.

This brake can also be operated manually with the front guard turned down to the guide bar.

To release the brake, pull up the front guard toward the front handle till a "click" sound is heard.

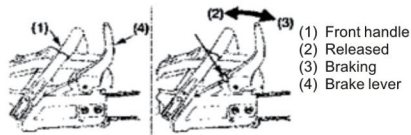

(1) Front handle
(2) Released
(3) Braking
(4) Brake lever

Caution

Be sure to confirm brake operation during daily inspection.

How to confirm:

- Turn off the engine.

- Holding the chain saw horizontally, release your hand from the front handle, hit the tip of the guide bar to a stump or a piece of wood, and confirm brake operation. Operating level varies by bar size.

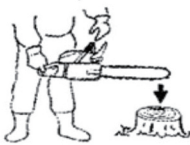

In case the brake is not effective, ask our dealer for inspection and repairs.

If the engine keeps rotating at high speed with the brake engaged, the clutch will overheat causing trouble.

When the brake engages during operation, immediately release the throttle lever to stop the engine.

• CARBURETOR ANTI-FREEZE MECHANISM

Operating chain saws in temperatures of 0 - 5°C at times of high humidity may result in ice forming within the carburetor, and this in turn may cause the output power of the engine to be reduced or for the engine to fail to operate smoothly.

This product has accordingly been designed with a ventilation hatch on the right side of the surface of the cylinder cover to allow warm air to be supplied to the engine and to thereby prevent icing from occurring.

Under normal circumstances the product should be used in the normal operating mode, i.e., in the

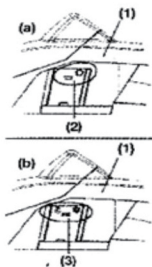

- (1) Cylinder cover
 (2) "Sunshine" mark
 (3) "Snow" mark
 i: a) Normal operating mode
 (b) Anti-freeze mode

mode which it is set at the time of shipment. However when the possibility exists that icing may occur, the unit should be set to operate in the anti-freeze mode before use

NOTE

Continuing to use the product in the anti-freeze mode even when temperatures have risen and returned to normal, may result in the engine failing to start properly or in the engine failing to operate at its normal speed, and for this reason you should always be sure to return the unit to the normal operating mode if there is no danger of icing occurring.

HOW TO SWITCH BETWEEN OPERATING MODES

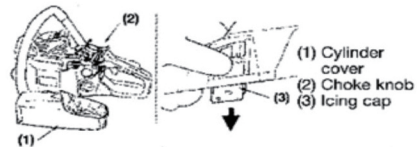

- Flip the engine switch to turn off the engine.
- Remove the cover to the air filter, remove the air filter, and then remove the choke knob from the cylinder cover.
- Loosen the screws holding the cylinder cover in place (i.e., the three screws on the inside and the one screw on the outside of the cover), and then remove the cylinder cover.
- Press with your finger down on the icing cap located on the right-hand side of the cylinder cover to remove the ICing cap.
- Adjust the icing cap so that the "snow" mark faces upwards and then return it to its original position in the cylinder cover.
- Fix the cylinder cover back into its original position, and then fix all other parts back into their proper positions.

STOPPING THE ENGINE

- Release the throttle lever to allow the engine to idle for a few minutes
- Set the switch to the "O" (STOP) position.



6. Sawing

⚠ WARNING!



- Before proceeding to your job, read the section "For Safe Operation". It is recommended to first practice sawing easy logs. This also helps you get accustomed to your unit.



- Always follow the safety regulations. The chain saw must only be used for cutting wood. It is forbidden to cut other types of material. Vibrations and kickback vary with different materials and the requirements of the safety regulations would not be respected. Do not use the chain saw as a lever for lifting, moving or splitting objects. Do not lock it over fixed stands. It is forbidden to hitch tools or applications to the PTO other than those specified by the manufacturer.

- It is not necessary to force the saw into the cut. Apply only light pressure while running the engine at full throttle.

- When the saw chain is caught in the cut, do not attempt to pull it out by force, but use a wedge or a lever to open the way.

• GUARD AGAINST KICKBACK



- This saw is equipped with a chain brake that will stop the chain in the event of kickback if operating properly. You must check the chain brake operation before each usage by running the saw at full the throttle for 1-2 seconds and pushing the front hand guard forward. The chain should stop immediately with the engine at full speed. If the chain is slow to stop or does not stop, replace the brake band and clutch drum before use.



- It is extremely important that the chain brake be checked for proper operation before each use and that the chain be sharp in order to maintain the kickback safety level of this saw. Removal of the safety devices, inadequate maintenance, or incorrect replacement of the bar or chain may increase the risk to serious personal injury due to kickback.

• FELLING A TREE

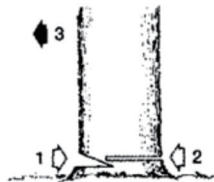

- (1) Notch cut
- (2) Felling cut
- (3) Felling direction

1. Decide the felling direction considering the wind, lean of the tree, location of heavy branches, ease of completing the task after felling and other factors.

2. While clearing the area around the tree, arrange a good foothold and retreat path

3. Make a notch cut one-third of the way into the tree on the felling side.
4. Make a felling cut from the opposite side of the notch and at a level slightly higher than the bottom of the notch.

⚠ WARNING! When you fell a tree, be sure to warn neighboring workers of the danger.

Bucking and Limbing

⚠ WARNING!

- Always ensure your foothold. Do not stand on the log.
- Be alert to the rolling over of a cut log. Especially when working on a slope, stand on the uphill side of the log.
- Follow the instructions in "For Safe Operation" to avoid kickback of the saw.

Before starting work, check the direction of bending force inside the log to be cut. Always finish cutting from the opposite side of the bending direction to prevent the guide bar from being caught in the cut.

A log lying on the ground

Saw down halfway, then roll the log over and cut from the opposite side.



A log hanging off the ground

In area "A", saw up from the bottom one-third and finish by sawing down from the top. In area "B", saw down from the top one-third and finish by sawing up from the bottom.

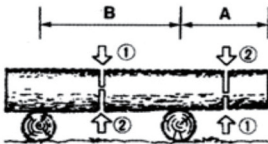

Cutting the limbs of Fallen Tree

First check to which side the limb is bent. Then make the initial cut from the bent side and finish by sawing from the opposite side.

⚠ WARNING! Be alert to the springing back of a cut limb.

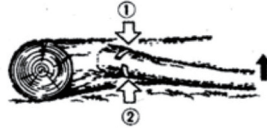

Pruning of Standing Tree

Cut up from the bottom, finish down from the top.

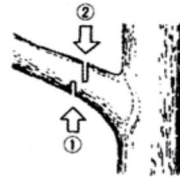

⚠ WARNING!

Do not work standing on unstable bases or rung ladders.
Do not overreach.
Do not cut above shoulder height.
Always use both your hands to hold the saw.

7. Maintenance

⚠ WARNING! Before cleaning, the inspecting or repairing the unit, make sure that engine has stopped and is cool. Disconnect the spark plug to prevent accidental starting.

• MAINTENANCE AFTER EACH USE

1. Air filter

Loosen the knob and remove the air cleaner cover.

Take off the filter element and brush off attached sawdust. When the filter is clogged with dust, separate it in halves and shake-wash with gasoline.

When using compressed air, blow from the inside.

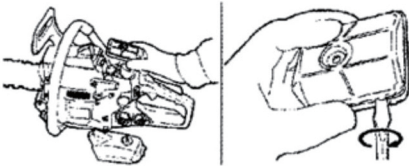

To assemble the cleaner halves, press the rim until it clicks.

NOTE

When installing the main filter, make sure that the grooves on the filter edge are correctly fit with the projections on the cylinder cover.

2. Oiling port

Dismount the guide bar and check the oiling port for clogging.

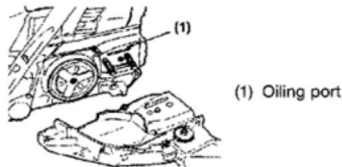

3. Guide bar

When the guide bar is dismounted, remove sawdust in the bar groove and the oiling port. Grease the nose sprocket from the feeding port on the tip of the bar

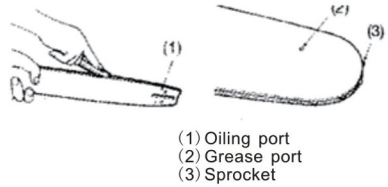

4. Others

Check for fuel leakage and loose fastenings and damage to major parts, especially handle joints and guide bar mounting.

If any defects are found, make sure to have them repaired before operating the saw again.

• PERIODICAL SERVICE POINTS

1. Cylinder fins

Dust clogging between the cylinder fins will cause overheating of the engine.

Periodically check and clean the cylinder fins after removing the air cleaner and the cylinder cover.

When installing the cylinder cover, make sure that switch wires and grommets are positioned correctly in place.



NOTE

Be sure to block the air intake hole.

2. Fuel filter

- Using a wire hook, take out the filter from the filler port.

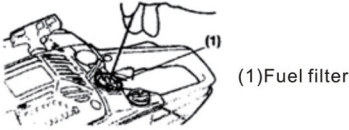

- Disassemble the filter and wash with gasoline. or replace with a new one if needed

NOTE

- After removing the filter, use a pinch to hold the end of the suction pipe.
- When assembling the filter, take care not to allow filter fibers or dust inside the suction pipe.

3. Spark plug

Clean the electrodes with a wire brush and reset the gap to 0.65 mm as necessary.

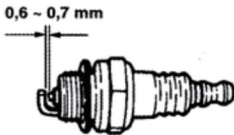

4. Sprocket

Check for cracks and for excessive wear interfering with the chain drive. If the wear is considerable, replace it with new one. Never fit a new chain on a worn sprocket, or a worn chain on a new sprocket.

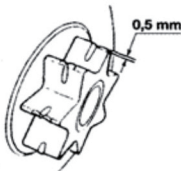

5. Front and Rear dampers

Replace if adhered part is peeled or crack is observed on the rubber part. Replace if the inside of the rear damper metal has been beaten by the stopper bolt and the clearance of the metal increased.

8. Maintenance of Saw Chain and Guide Bar

1. Saw Chain

⚠ WARNING! It is very important for smooth and safe operation to always keep the cutters sharp.

The cutters need to be sharpened when:

- Sawdust becomes powder-like.
- You need extra force to saw in.
- The cut path does not go straight.
- Vibration increases.
- Fuel consumption increases.

Cutter setting standards

⚠ WARNING! Be sure to wear safety gloves.

Before filing:

- Make sure the saw chain is held securely.
- Make sure the engine is stopped.
- Use a round file of proper size for the chain (see "Chain maintenance table").

Place the file on the cutter and push straight forward.
Keep the file position as illustrated.

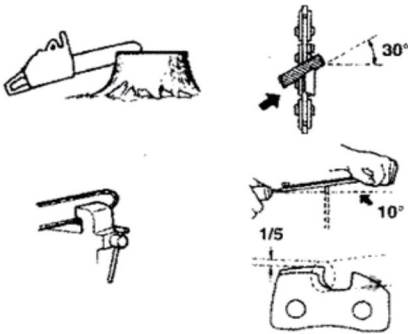

After each cutter has been filed, check the depth gauge and file it to the proper level as illustrated.

⚠ WARNING! Be sure to round off the front edge to reduce the chance of kickback or tie-strap breakage.

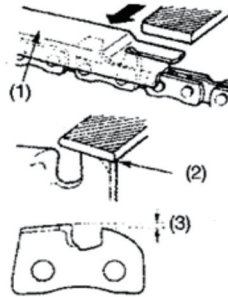

- (1) Appropriate gauge checker
- (2) Depth gauge standard
- (3) Make the shoulder round: (see "Chain maintenance table")

Make sure every cutter has the same length and edge angles as illustrated.

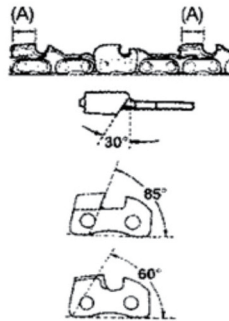

- (A) Cutter length
- (300) Filing angle
- (850) Side plate angle
- (600) Top plate cutting angle

2. Guide Bar

- Reverse the bar occasionally to prevent partial wear.
- The bar rail should always be square.

Check for wear of the bar rail. Apply a ruler to the bar and the outside of a cutter. If a gap is observed between them, the rail is normal. Otherwise, the bar rail is worn. Such a bar needs to be corrected or replaced.

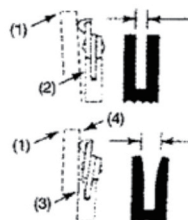

- (1) Ruler
- (2) Gap
- (3) No gap
- (4) Chain tilts

3. Chain maintenance table

⚠ WARNING! The characteristic data of the chain and bar homologated for this machine are shown in the “EC Conformity Statement” that accompanies same machine. Do not use other types of chain or. bar for safety reasons.

The table gives the sharpening data for different types of Chain. without this giving the possibility of using chains other than me homologated one.

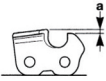
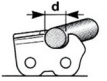
Chain stroke		limiter tooth level(a)		File diameter(d)	
					
inches	mm	inches	mm	inches	mm
3/8mini	9,35	0,018	0,45	5/32	4,0
0,325	8,25	0,026	0,65	3/16	4,8
3/8	9,32	0,026	0,65	13/64	5,2
0,404	10,26	0,031	0,80	7/32	5,6

9. Troubleshooting Guide

PROBLEME	CAUSE	REMEDY
1) Starting failure WARNING Make sure the icing prevention system is not working.	Check fuel for water or substandard mixture.	Replace with proper fuel.
	Check for engine flooding;*	Remove and dry the spark plug. Then pull the starter again with no choke.
	Check spark ignition.	Replace with a new plug.
2) Lack of power/Poor acceleration/Rough idling	Check fuel for water or substandard mixture.	Replace with proper fuel.
	Check air filter and fuel filter for clogging.	Clean.
	Check carburetor for inadequate adjustment.	Readjust speed needles.
3) Oil does not come out	Check oil for substandard quality.	Replace.
	Check oil passage and ports for clogging.	Clean.

10. Specifications

1	Chain saw Model	W46542538/W46542539/W46542840
2	Mass (without guide bar and chain)	5.50 (kg)
3	Dimensions (without guide bar and chain)	410x235x265 (mm)
4	Fuel	Mixture (Gasoline 40: Two-cycle oil 1)
5	Fuel tank capacity	550 (ml)
6	Chain oil	Motor oil SAE#10W-30
7	oil tank capacity	260 (ml)
8	Engine displacement	58cc
9	Maximum engine power	2.4kw
10	Maximum engine speed with cutting attachment	12000rpm
11	Maximum Engina speed at idling	3000±200rpm
12	Maximum cutting length	500/550(MM)
13	Sprocket	7Tx0.325
14	Saw chain type	CHINESE/OREGON
15	Saw chain pitch	0.325(in)
16	Saw chain gauge	0.058(in)
17	Guide bar type	Sprocket nose or Hard nose
18	Saw e bar size	20/22" (in)
19	Oil feeding system	Automatic pump with adjuster

NOTICE: Specifications are subject to change without notice.