

NUU  **GARDEN**[®]

———— ENJOY LIFE · SHARE HAPPINESS ————

INSTRUCTION MANUAL

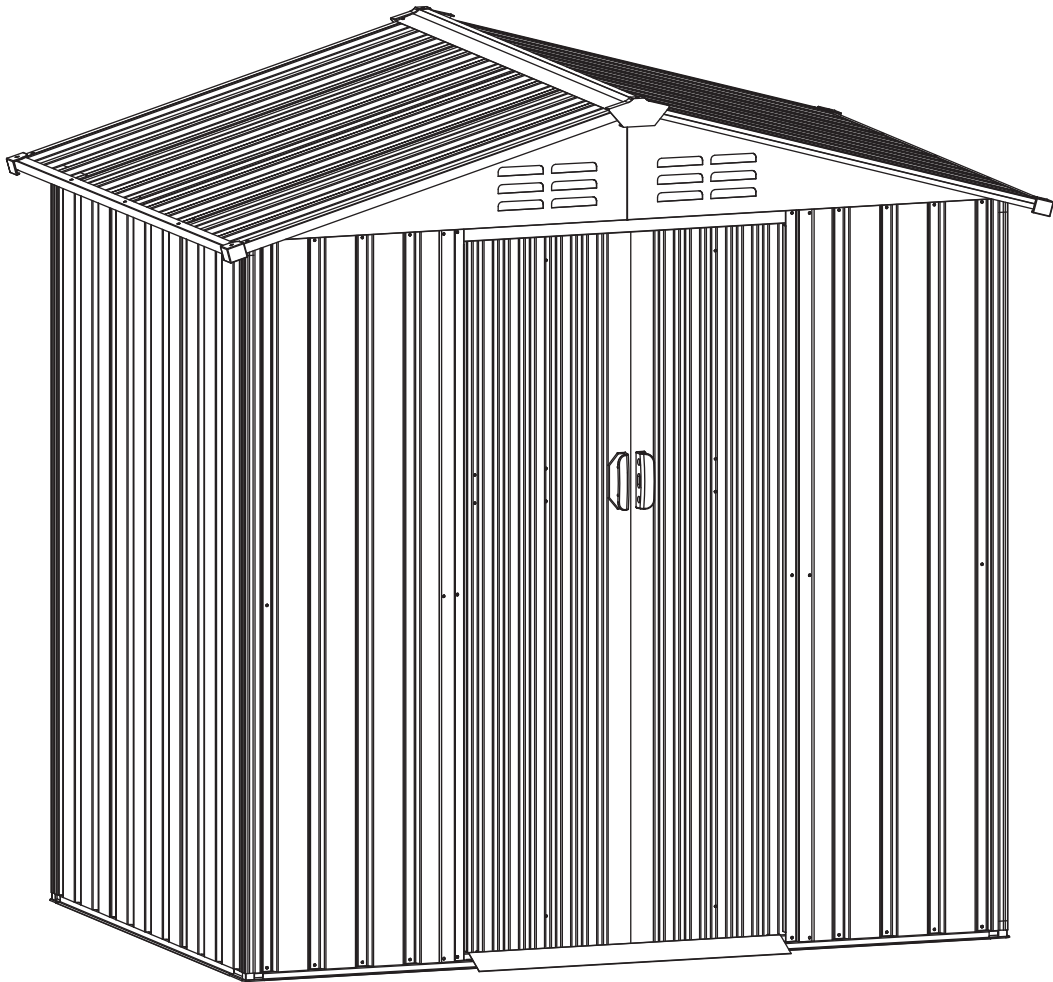

Galvanized Sheet Tool Room

GS001-01/G002-BN/G002-BK

INTRODUCTION









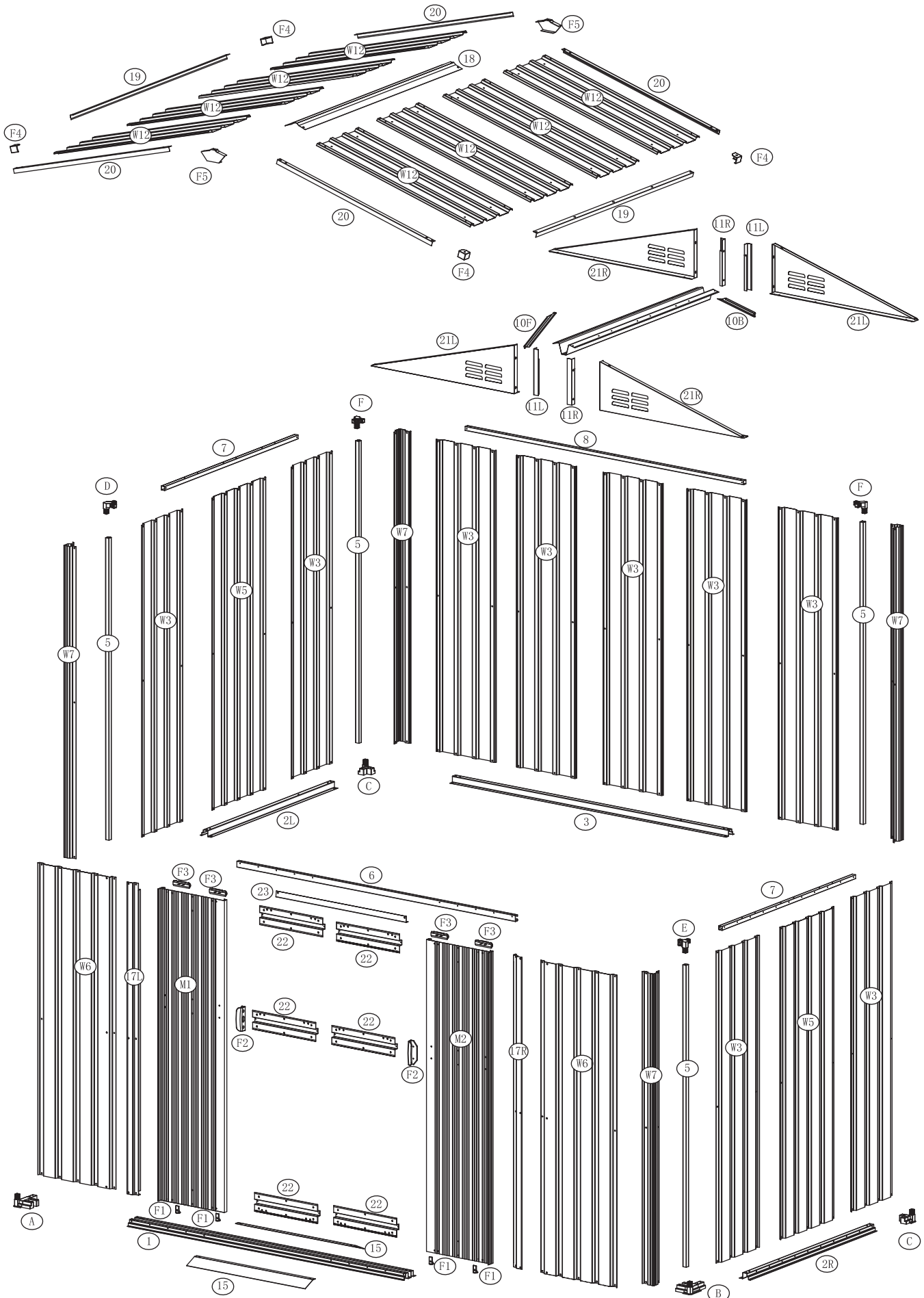

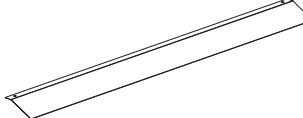
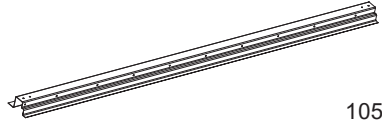
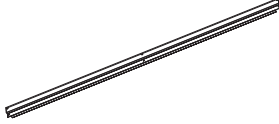
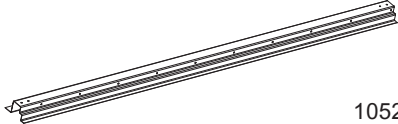
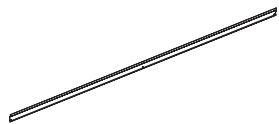
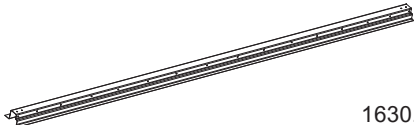
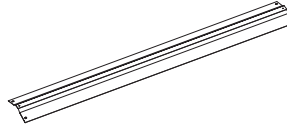
Thanks for purchasing and trusting NUUGARDEN with your home decorating plans. This product is a piece of furniture designed and made by NUUGARDEN Corp.

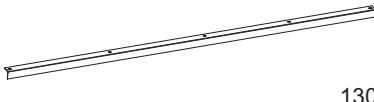

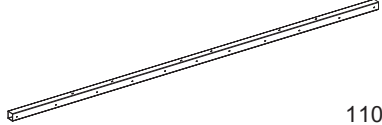

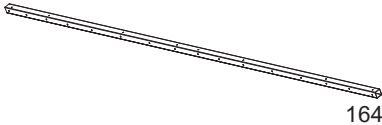

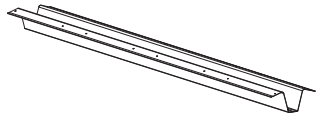
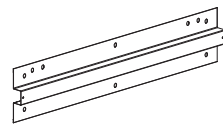
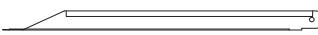
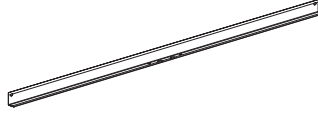
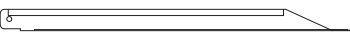
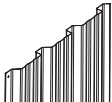
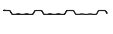

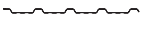

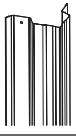
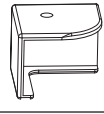
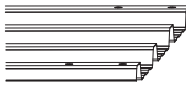
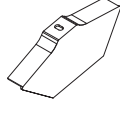
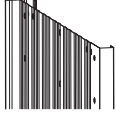

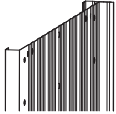
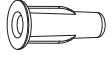
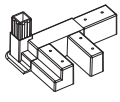

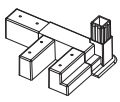

We are committed to R&D and innovation and creating the most exquisite and diverse outdoor series.

After unpacking and before every use, check whether the item shows any damage. In addition, check that you have all parts and hardware before assembly. If there is any damage, please do not use it and call customer service at (800) 257-7108 or email service@nuugarden.com. If you do not have all the parts lists, have your dealer contact us and we will send them to you immediately.

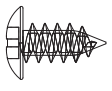
This item of furniture is intended for indoor and outdoor use. Please take time to read and follow the instructions below. Then, use this item as described in this operating manual. We accept no liability for damage caused by improper use.



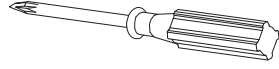

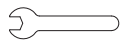
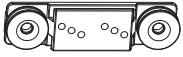
NO.	PART.	Qty.	NO.	PART.	Qty.
1	 1630.2mm	1	15	 700mm	2
2L	 1052.4mm	1	17L	 1560mm	1
2R	 1052.4mm	1	17R	 1560mm	1
3	 1630.2mm	1	18	 1304mm	1
5	 1510mm	4	19	 1304mm	2
6	 1643.4mm	1	20	 951mm	4
7	 1108.4mm	2	21L		2
8	 1643.4mm	1	21R		2
9	 1195mm	1	22	 372mm	6
10F	 353mm	1	23	 770mm	1
10B	 353mm	1	W3	 1560mm	9
11L	 230mm	2	W5	 1560mm	2
11R	 230mm	2	W6	 1560mm	2

NO.	PART.	Qty.	NO.	PART.	Qty.
W7	 1560mm	4	F4		4
W12	 943mm	8	F5		2
M1	 1560mm	1	F7		230
M2	 1560mm	1	F8		36
A		1	F9		2
B		1	S4		226
C		2	S6		56
D		1	S7		56
E		1	S8		12
F		2	S9		4
F1		4	S12		1
F2		2	S15		1
F3		4			

ASSEMBLY INSTRUCTIONS

! CAVEAT

Note: Please tighten the bolts after each installation step.

NO.	PART.	Qty.
1	 1630, 2mm	1
15	 700mm	2
S4		4

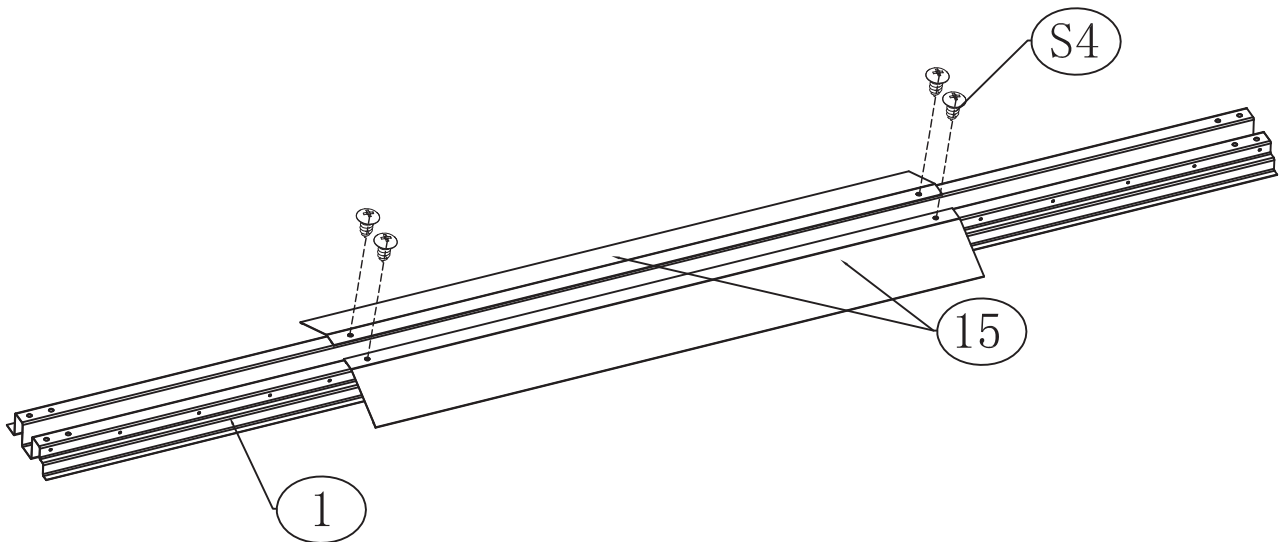







STEP 1

Attach frame (1) to 2 pedals (15) using 4 screws (S4).

ASSEMBLY INSTRUCTIONS

CAVEAT

Note: Please tighten the bolts after each installation step.

NO.	PART.	Qty.	NO.	PART.	Qty.
2L	 1052.4mm	1	A		1
2R	 1052.4mm	1	B		1
3	 1630.2mm	1	C		2
			S4		20

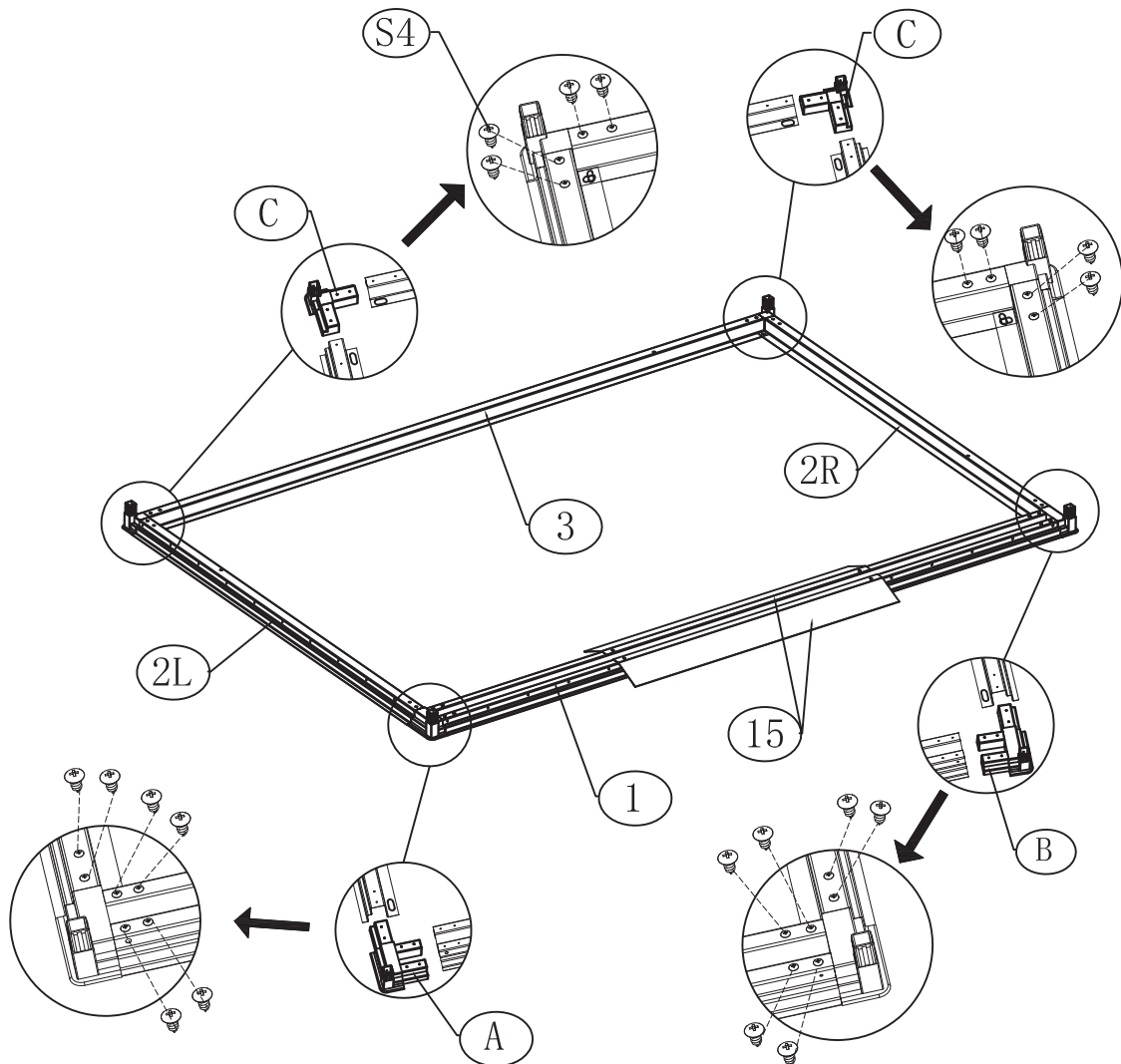

STEP 2

1. Attach frame (1) to frames (2L&2R) with connectors (A&B) using 12 screws (S4).
2. Attach frame (3) to frames (2L&2R) with 2 connectors (C) using 8 screws (S4).

ASSEMBLY INSTRUCTIONS



CAVEAT

Note: Please tighten the bolts after each installation step.

NO.	PART.	Qty.
5	 1510mm	4

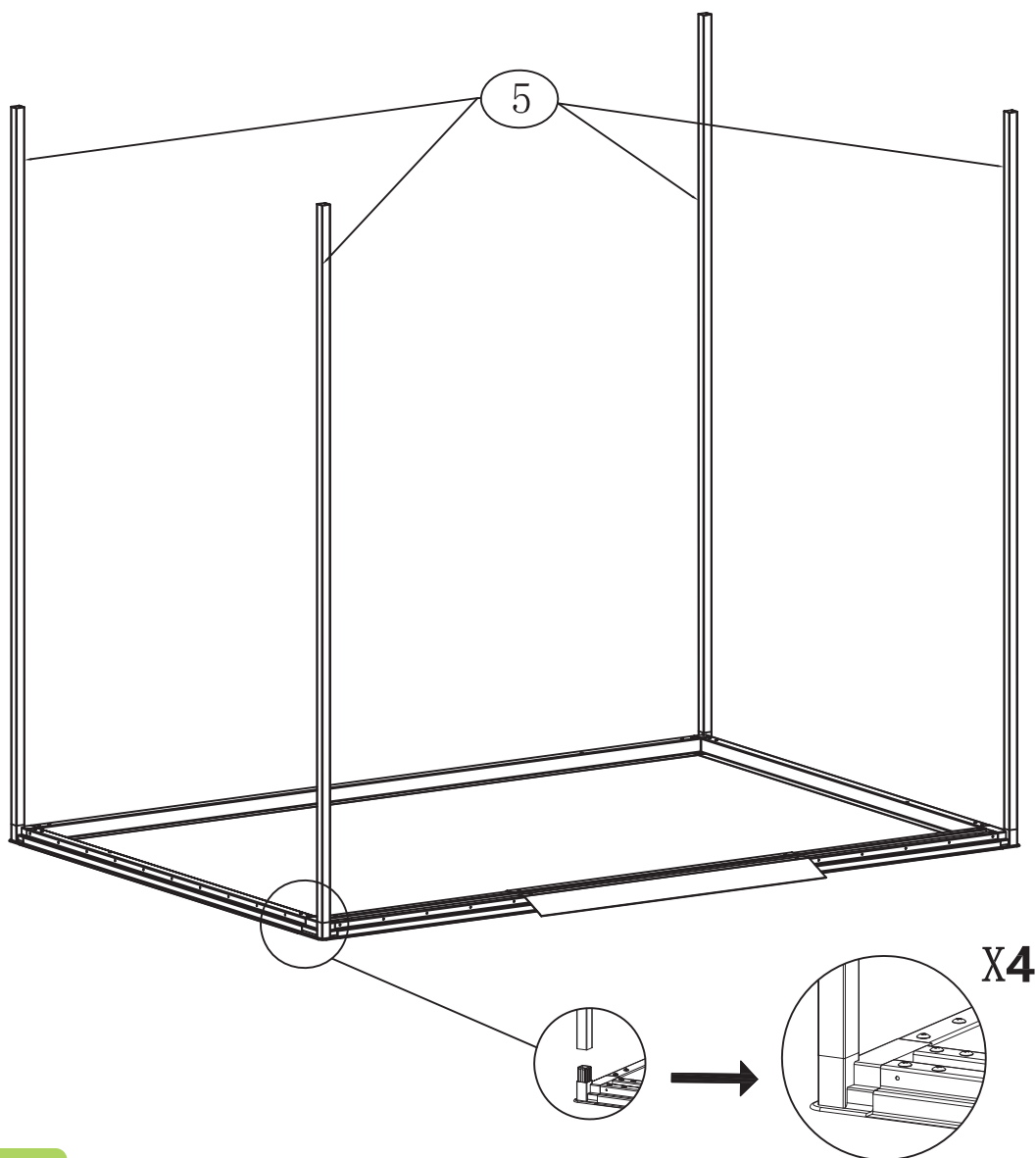

STEP 3

Insert support rods (5) at the four corners.

ASSEMBLY INSTRUCTIONS

! CAVEAT

Note: Please tighten the bolts after each installation step.

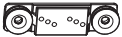
NO.	PART.	Qty.
6	 1643.4mm	1
F3		4

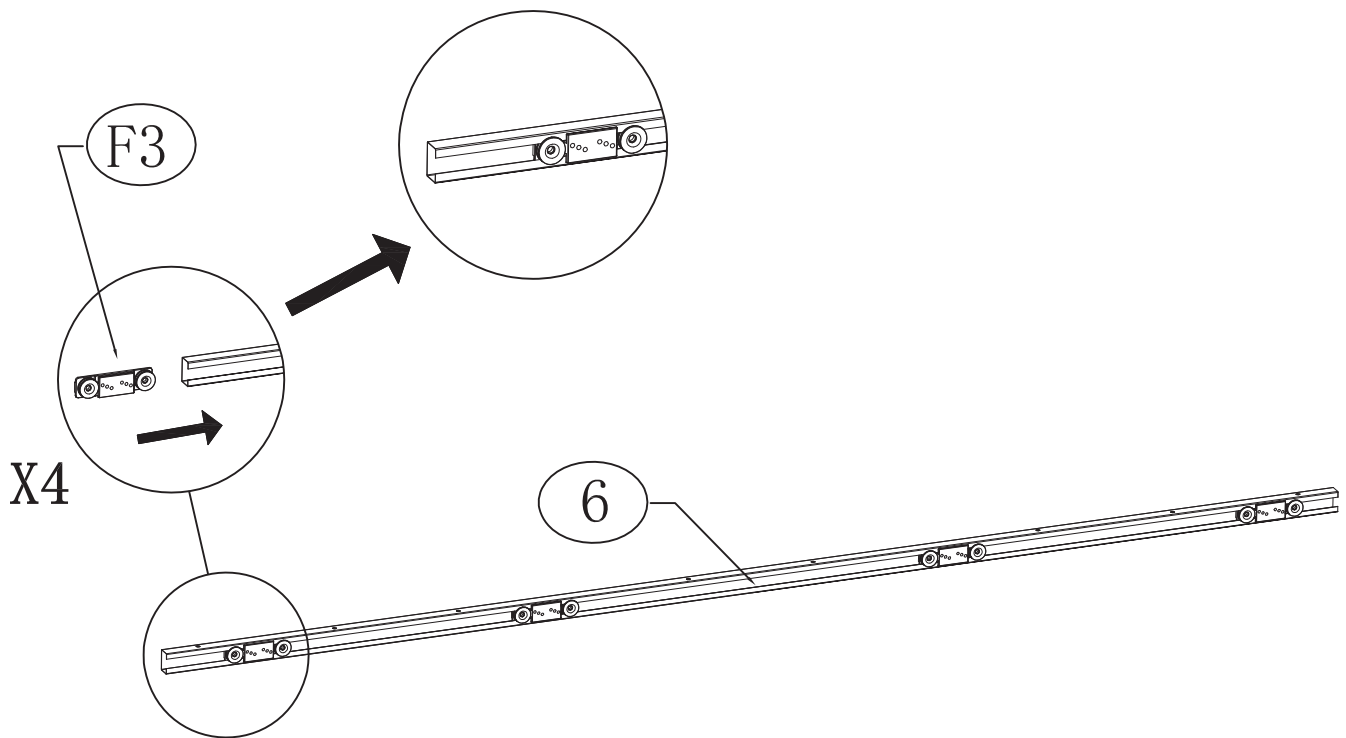







STEP 4

Install 4 connectors (F3) in frame (6).

ASSEMBLY INSTRUCTIONS

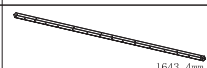
CAVEAT

Note: Please tighten the bolts after each installation step.

NO.	PART.	Qty.	NO.	PART.	Qty.
7	 1108.4mm	2	D		1
8	 1643.4mm	1	E		1
			F		2
			S4		6

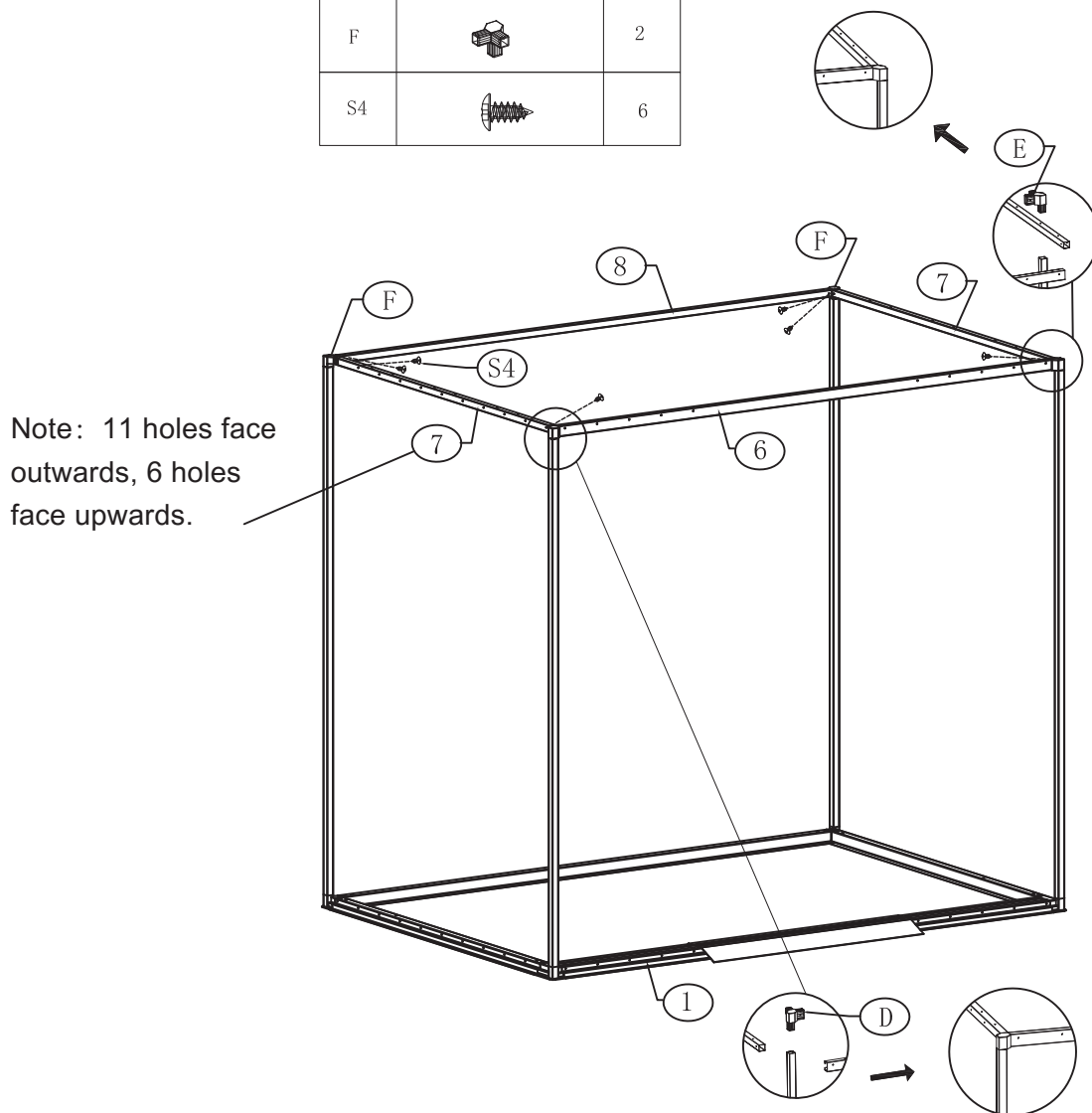







STEP 5

Attach 4 frames (6&7&8) to 4 support rods (5) with 4 connectors (D&E&F) using 6 screws (S4).

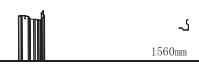
ASSEMBLY INSTRUCTIONS

CAVEAT

Note: Please tighten the bolts after each installation step.

NO.	PART.	Qty.	NO.	PART.	Qty.
W7		2	S4		22
W3		2	S6		4
W5		1	S7		4
			F7		26

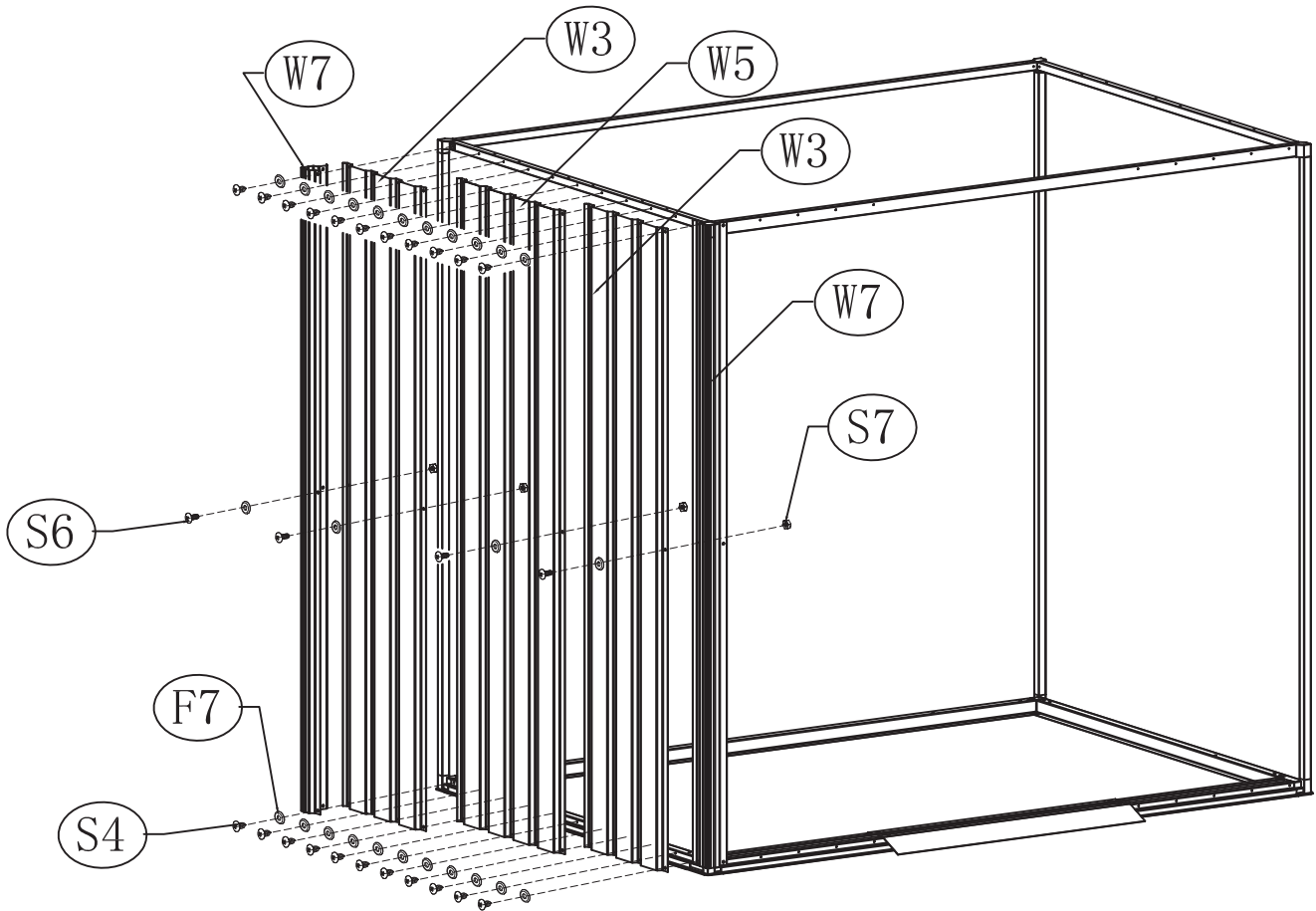







STEP 6

Install one side frames (W7&W3&W5) using 22 screws (S4), 4 screws (S6), 4 nuts (S7) and 26 washers (F7).

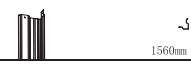
ASSEMBLY INSTRUCTIONS

CAVEAT

Note: Please tighten the bolts after each installation step.

NO.	PART.	Qty.	NO.	PART.	Qty.
W7	 1560mm	2	S4		22
W3	 1560mm	2	S6		4
W5	 1560mm	1	S7		4
			F7		26

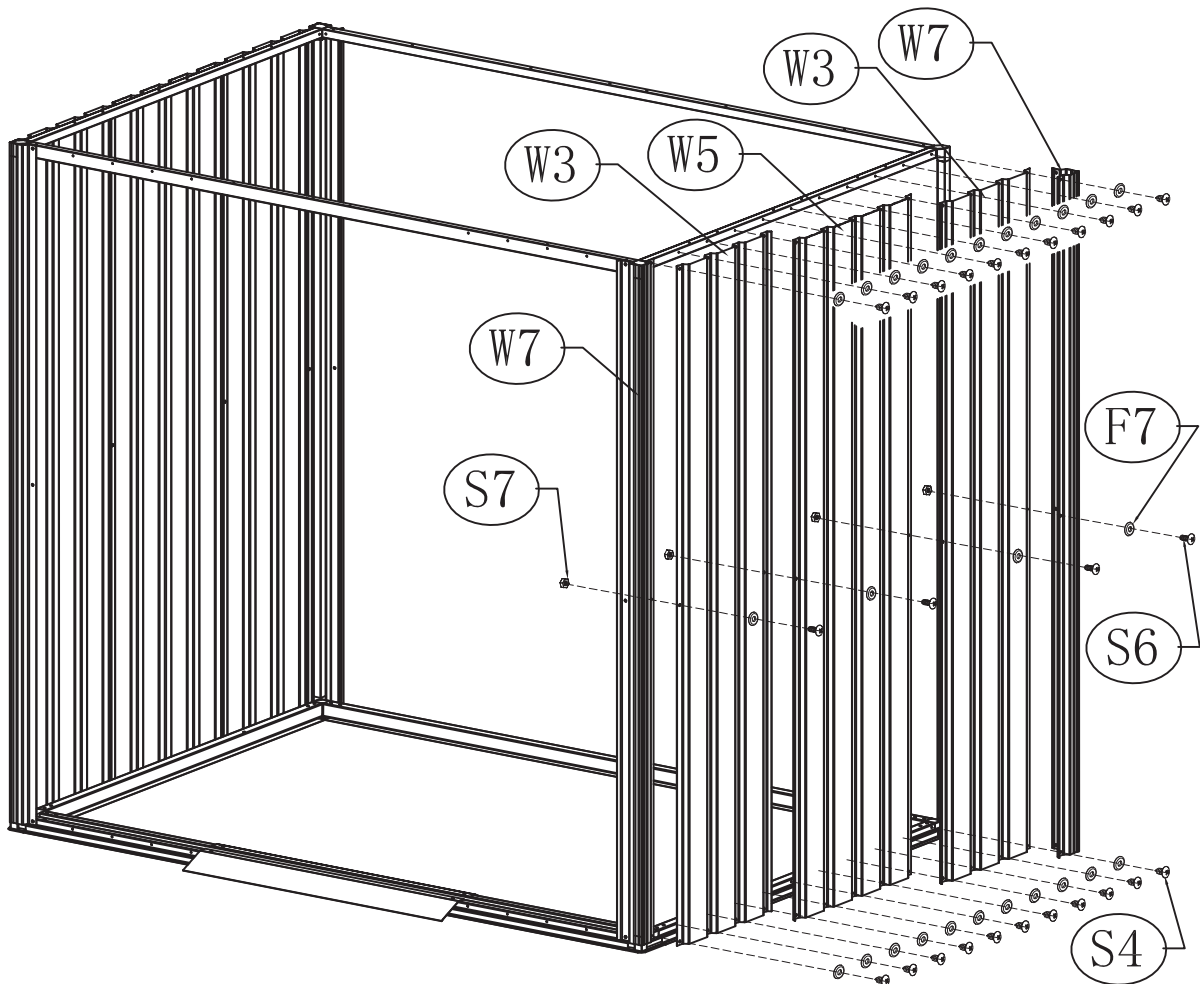





STEP 7

Install the other side frames in the same way.

ASSEMBLY INSTRUCTIONS

CAVEAT

Note: Please tighten the bolts after each installation step.

NO.	PART.	Qty.
W3	 1560mm	5
S4		32
S6		6
S7		6
F7		38

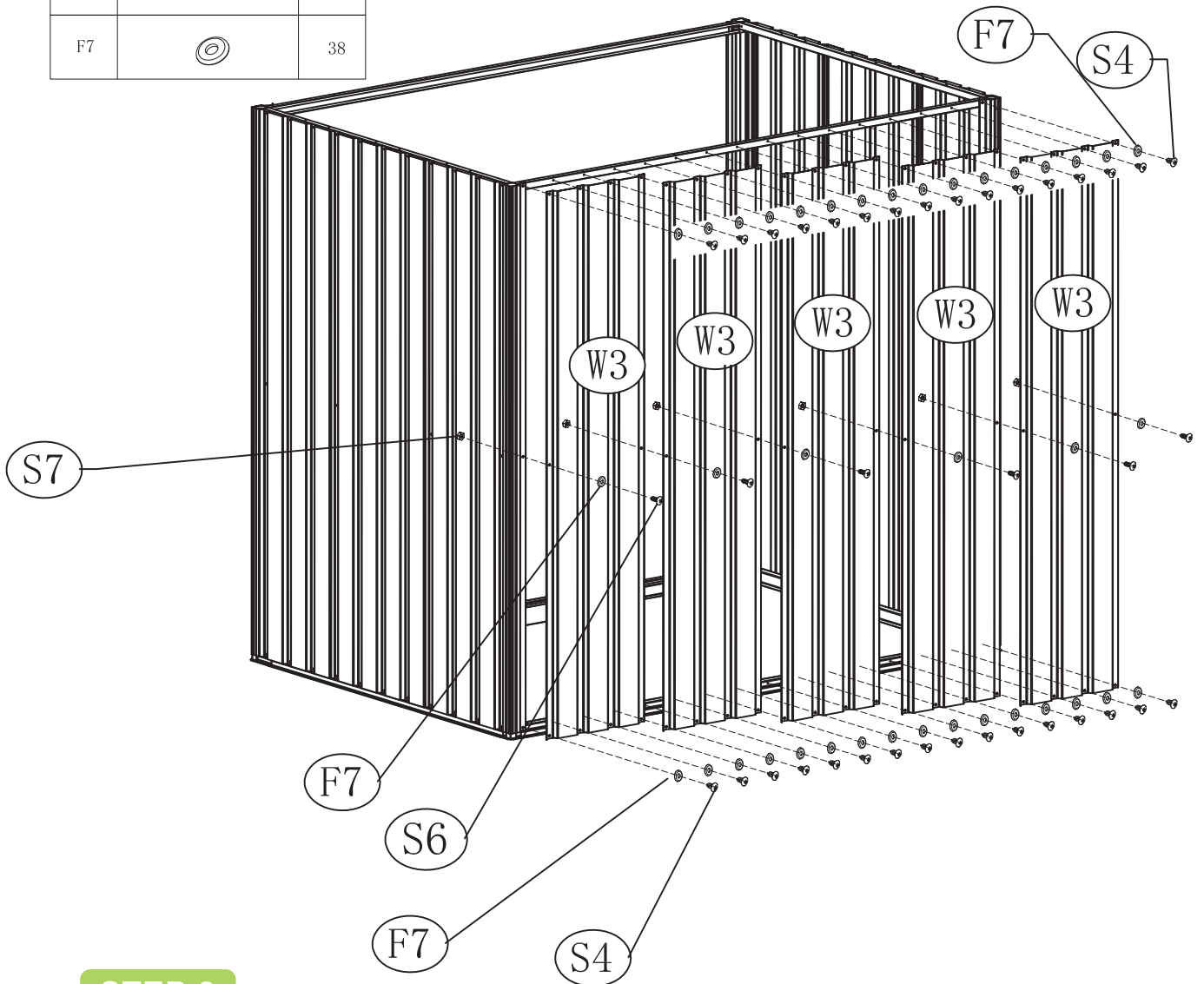







STEP 8

Install 5 frames (W3) using 32 screws (S4), 6 screws (S6), 6 nuts (S7) and 38 washers (F7).

ASSEMBLY INSTRUCTIONS

CAVEAT

Note: Please tighten the bolts after each installation step.

NO.	PART.	Qty.	NO.	PART.	Qty.
17L		1	S6		8
17R		1	S7		8
W6		2	F7		8

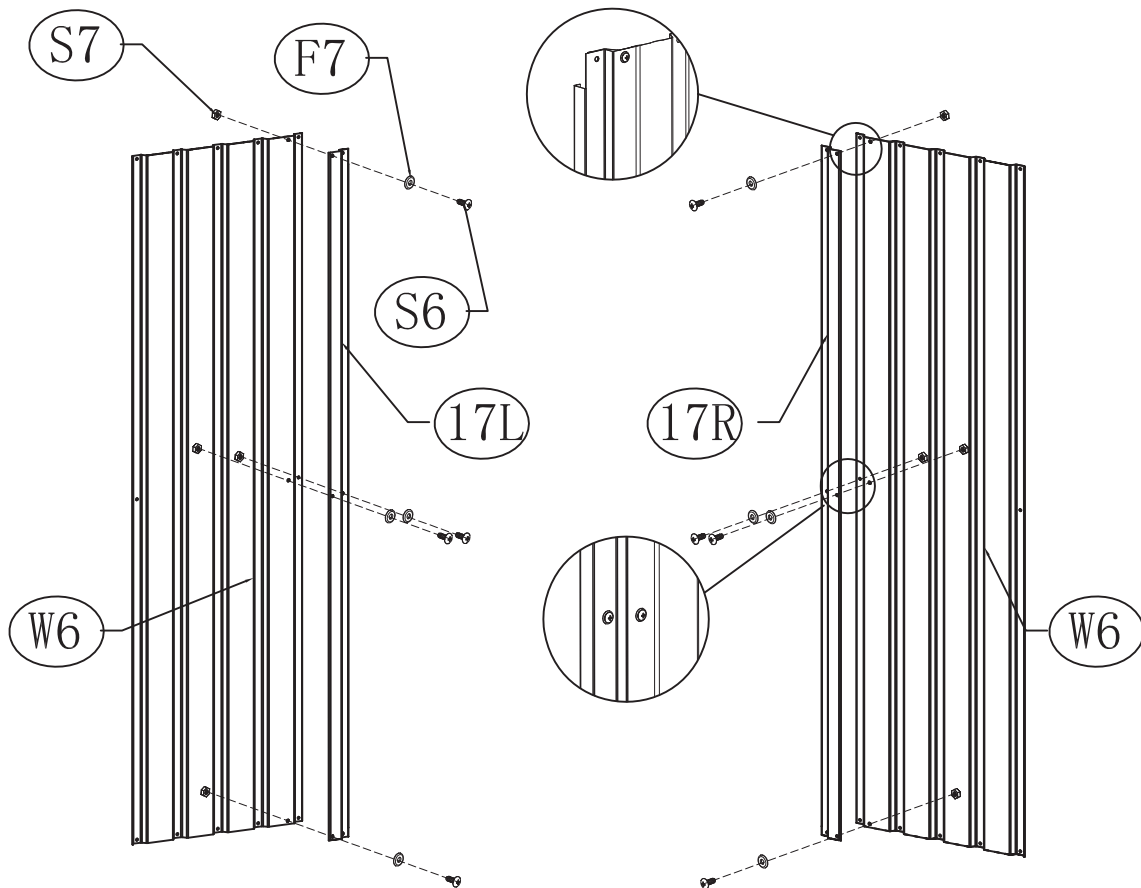





STEP 9

Attach frame (W6) to frame (17L) using 4 screws (S6), 4 nuts (S7) and 4 washers (F7). Install frame (W6) and frame (17R) in the same way.

ASSEMBLY INSTRUCTIONS

CAVEAT

Note: Please tighten the bolts after each installation step.

NO.	PART.	Qty.
23	 770mm	1
S4		20
S6		2
S7		2
F7		22

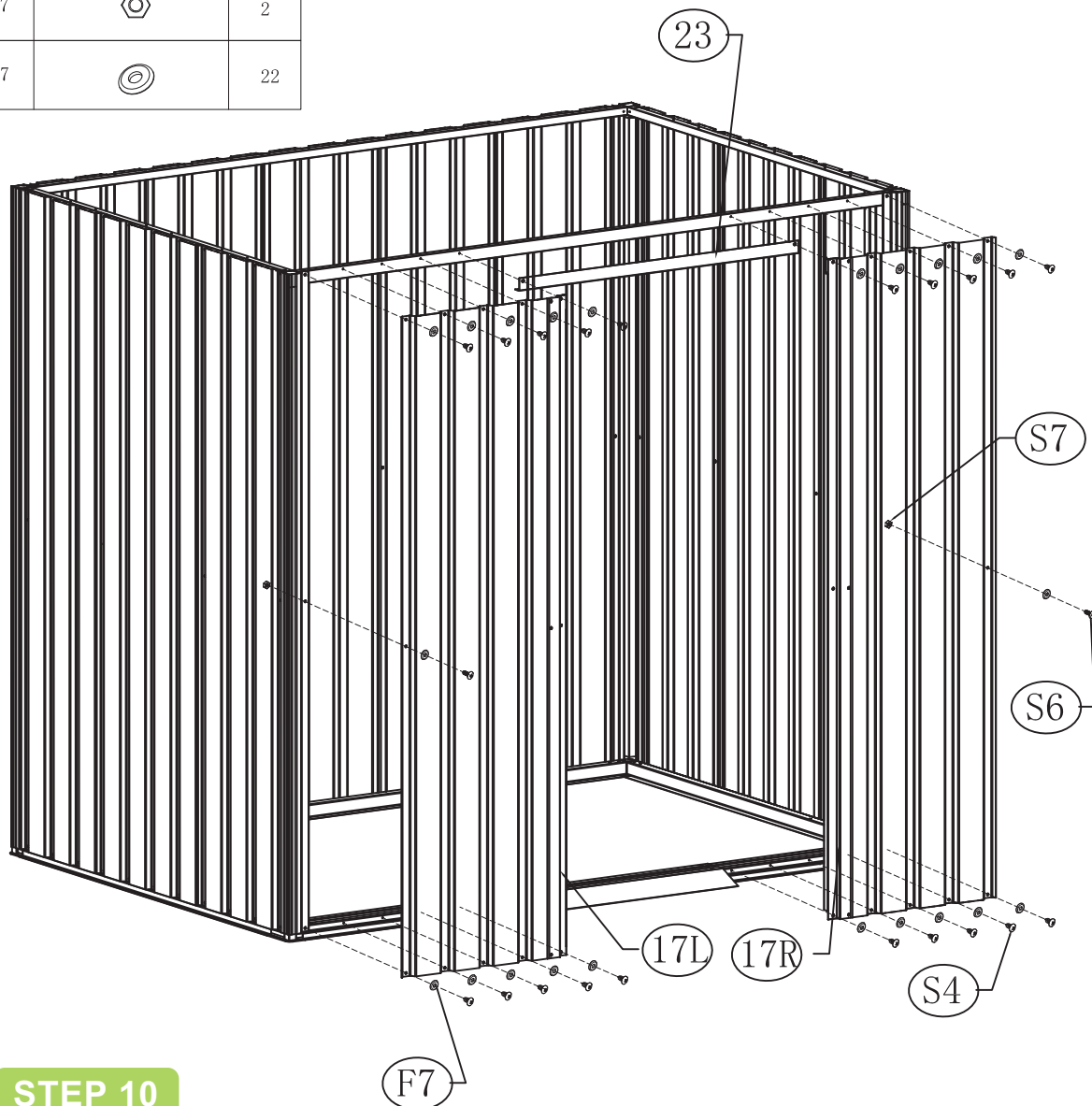









STEP 10

Install the frames (17L&17R) which installed in the previous step and frame (23) onto the main frame using 20 screws (S4), 2 screws (S6), 2 nuts (S7) and 22 washers (F7).

ASSEMBLY INSTRUCTIONS

CAVEAT

Note: Please tighten the bolts after each installation step.

NO.	PART.	Qty.	NO.	PART.	Qty.
21L		2	10F	 353mm	1
21R		2	10B	 353mm	1
11L	 230mm	2	S6		4
11R	 230mm	2	S7		4

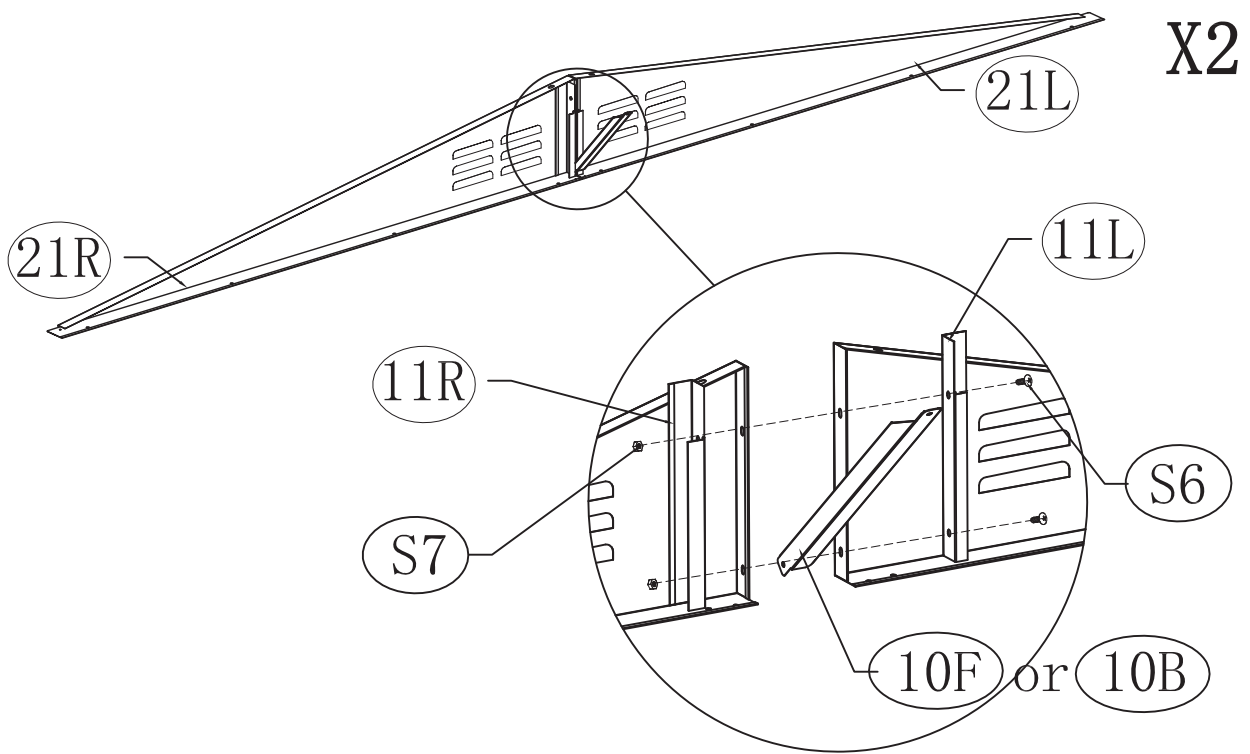

STEP 11

Attach windows (21R&21L) to frames (11R&11L) with connector (10F or 10B) using 4 screws (S6) and 4 nuts (S7).

ASSEMBLY INSTRUCTIONS

CAVEAT

Note: Please tighten the bolts after each installation step.

NO.	PART.	Qty.
S4		16

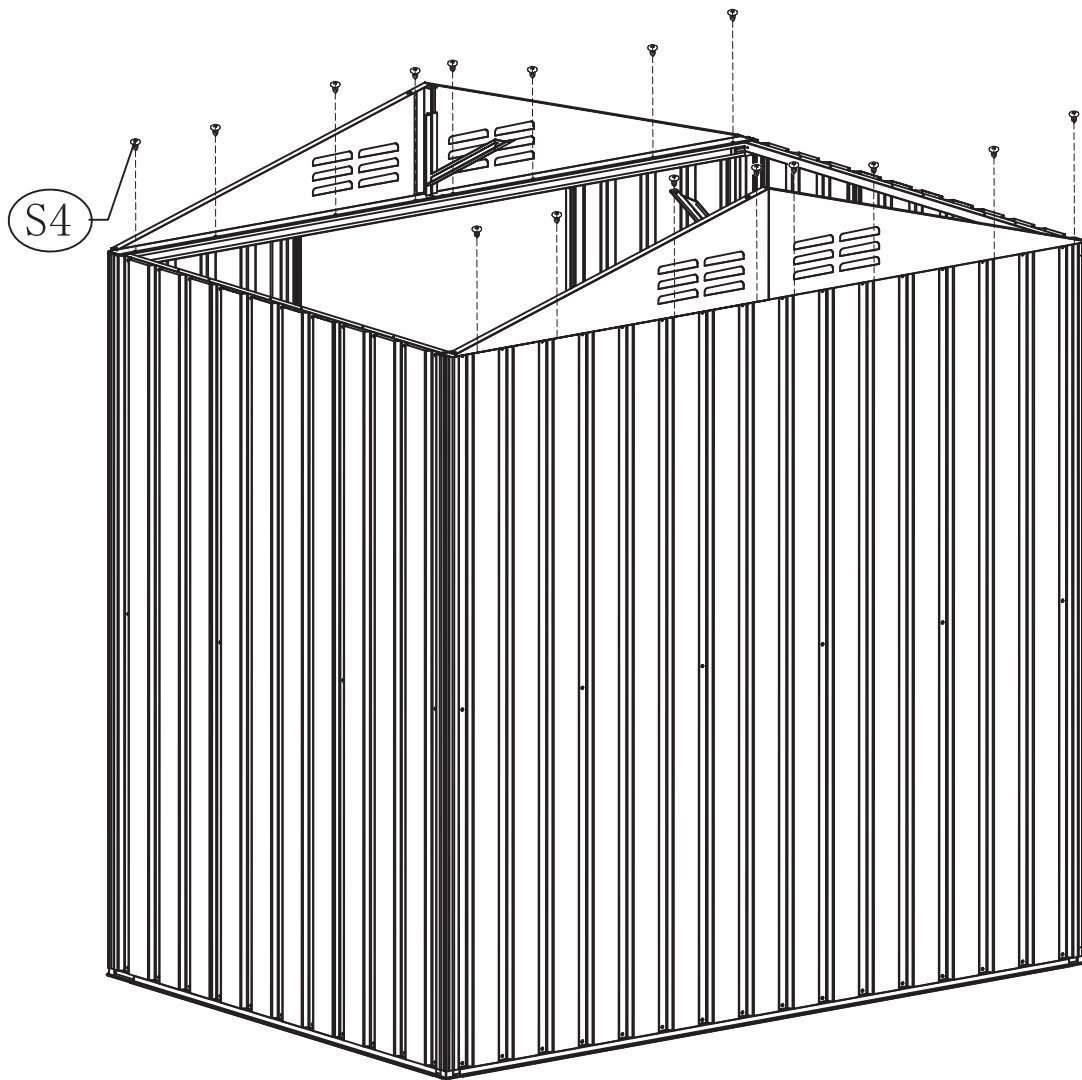

STEP 12



Install the spliced windows onto the main frame using 16 screws (S4).

ASSEMBLY INSTRUCTIONS



CAVEAT

Note: Please tighten the bolts after each installation step.

NO.	PART.	Qty.
9	 1195mm	1
S4		2

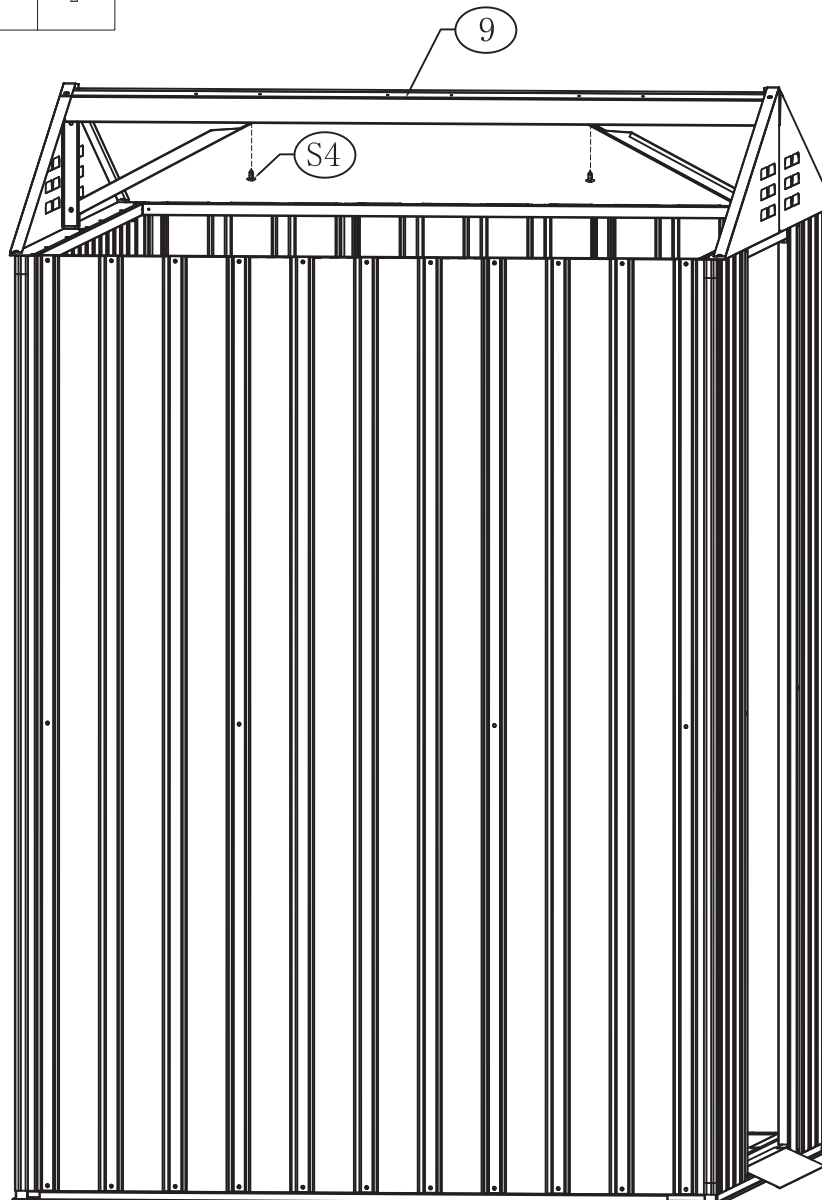





STEP 13

Attach the beam (9) to windows using 2 screws (S4).

ASSEMBLY INSTRUCTIONS

 **CAVEAT**

Note: Please tighten the bolts after each installation step.

NO.	PART.	Qty.
W12	  943mm	8
S4		50
F7		50

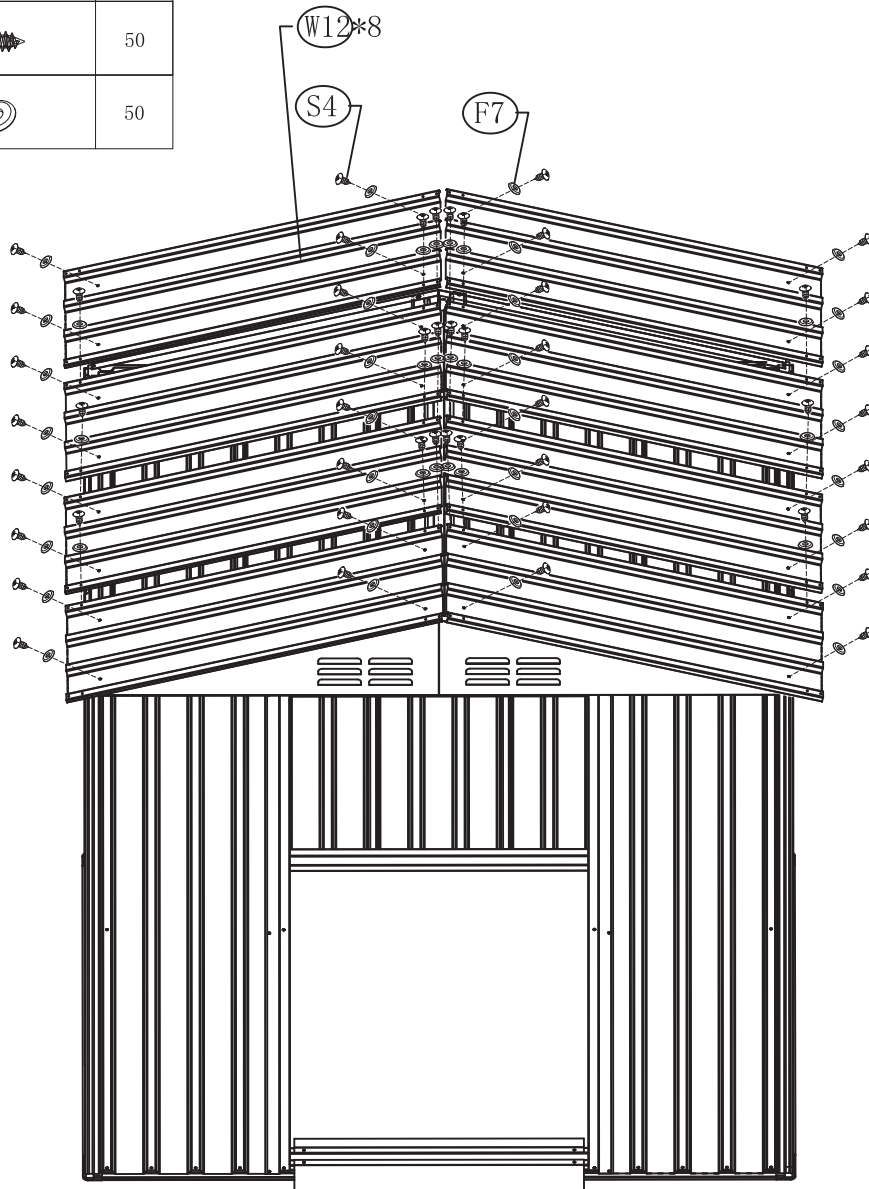



STEP 14

Install 8 roof frames (W12) using 50 screws (S4) and 50 washers (F7).

ASSEMBLY INSTRUCTIONS

CAVEAT

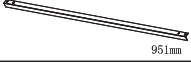
Note: Please tighten the bolts after each installation step.

NO.	PART.	Qty.
20		4
S4		8
F7		8

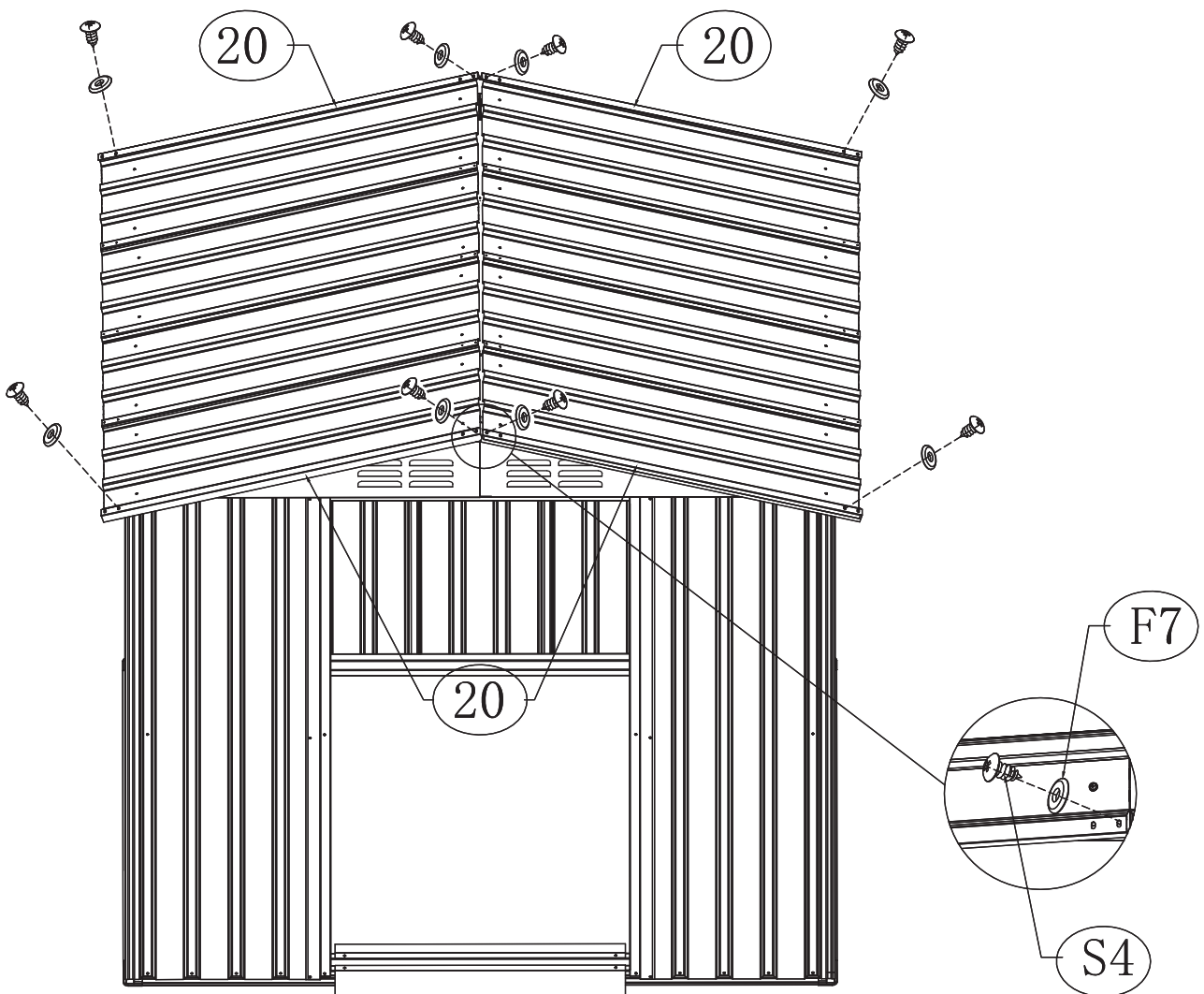





STEP 15

Attach 4 frames (20) to roof using 8 screws (S4) and 8 washers (F7).

ASSEMBLY INSTRUCTIONS

CAVEAT

Note: Please tighten the bolts after each installation step.

NO.	PART.	Qty.
19	 1304mm	2
F4		4
S4		6
S8		4
F7		10

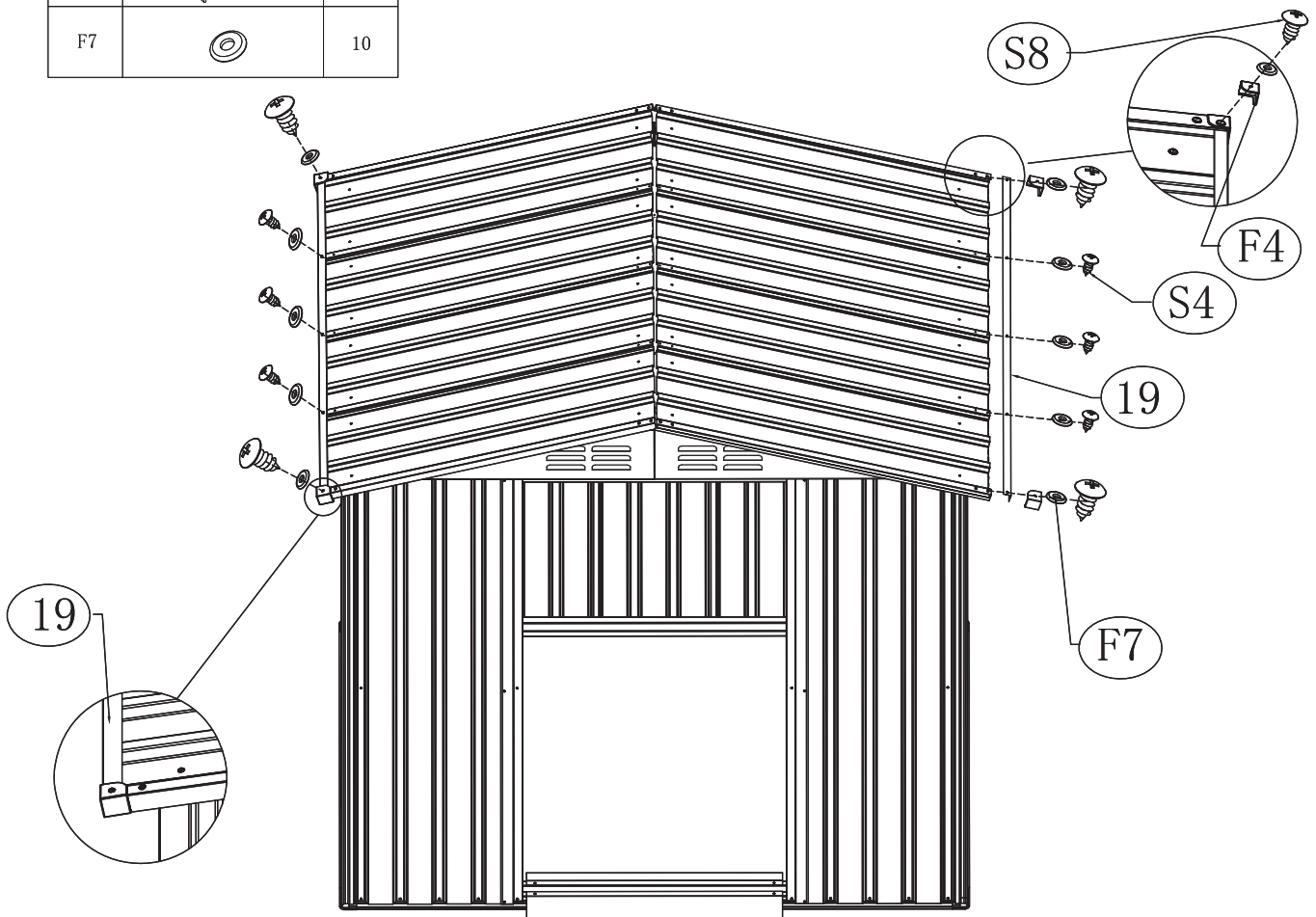

STEP 16

Install 2 frames (19) and 4 connectors (F4) using 6 screws (S4), 4 screws (S8) and 10 washers (F7).

ASSEMBLY INSTRUCTIONS

CAVEAT

Note: Please tighten the bolts after each installation step.

NO.	PART.	Qty.
F8		36

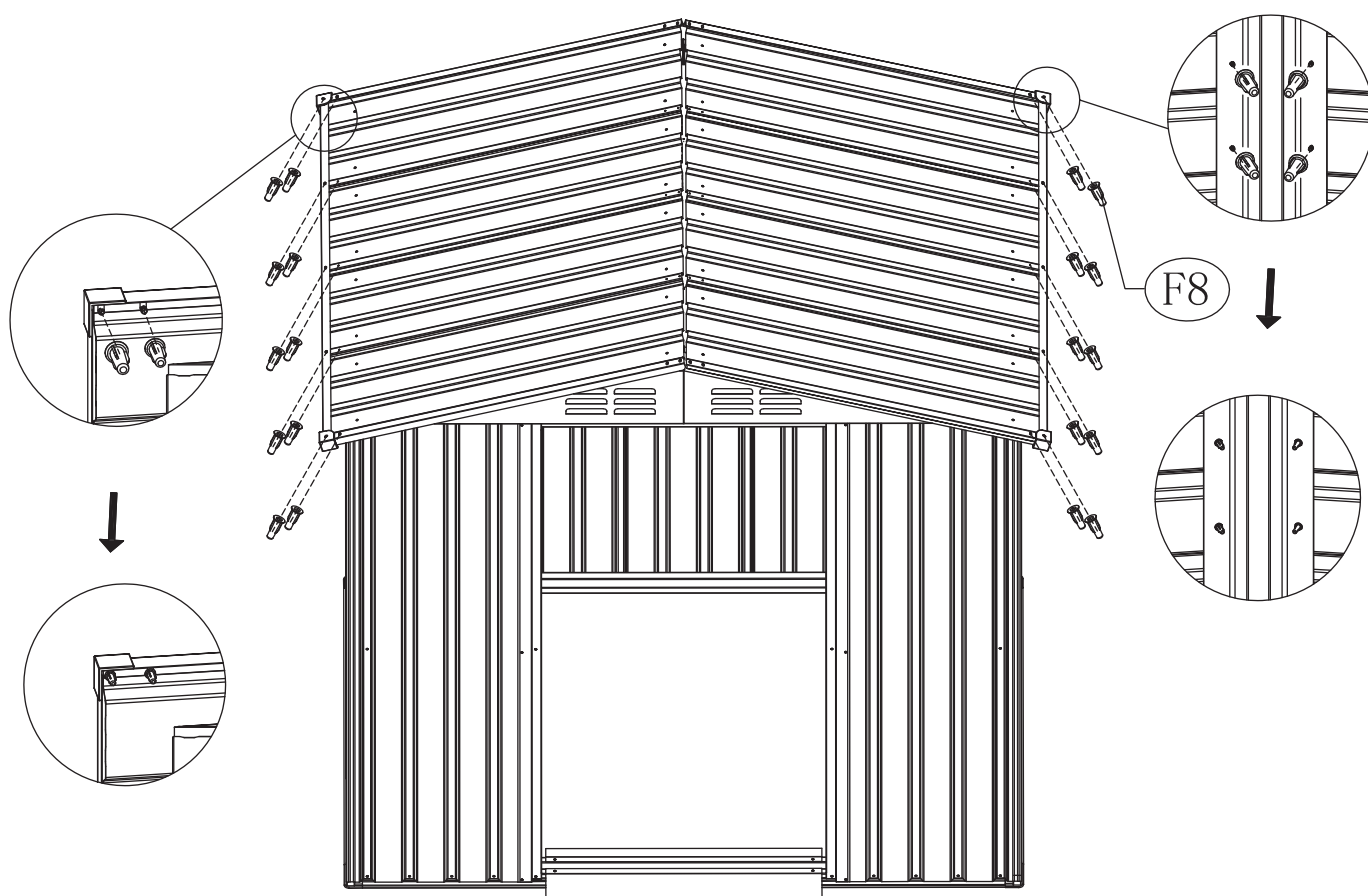





STEP 17

Install 36 roof screws (F8).

ASSEMBLY INSTRUCTIONS

CAVEAT

Note: Please tighten the bolts after each installation step.

NO.	PART.	Qty.
18	 1304mm	1
F5		2
S4		6
F7		6

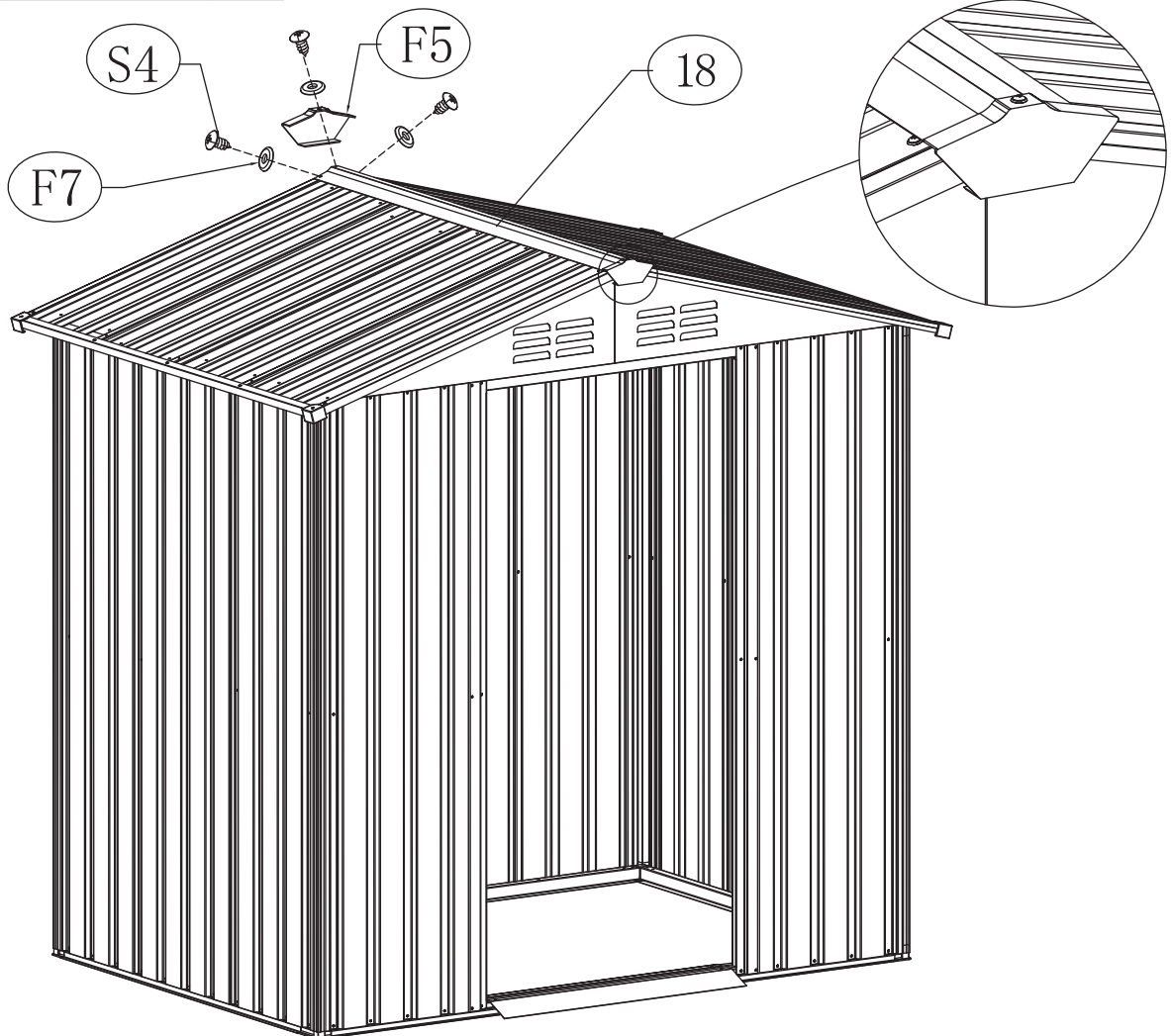







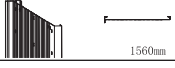

STEP 18

Install roof frame (18) and 2 plastic parts (F5) using 6 screws (S4) and 6 washers (F7).

ASSEMBLY INSTRUCTIONS

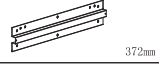
CAVEAT

Note: Please tighten the bolts after each installation step.

NO.	PART.	Qty.	NO.	PART.	Qty.
M1		1	S4		12
M2		1	S6		24
22		6	S7		24
F1		4	F7		36

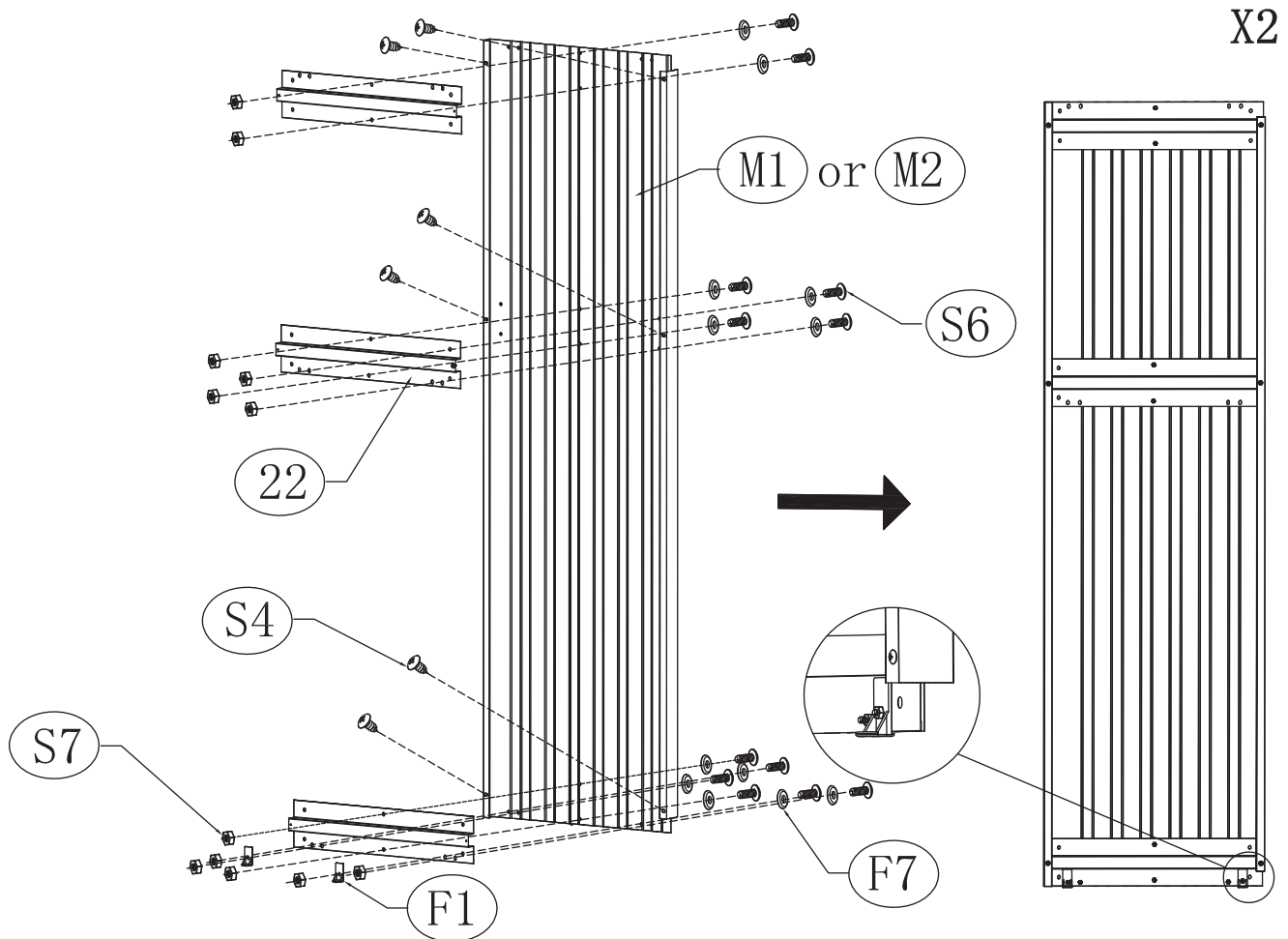





STEP 19

Attach 3 connectors (22) and 2 connectors (F1) to the door (M1) using 6 screws (S4), 12 screws (S6), 12 nuts (S7) and 18 washers (F7). Install the door (M2) in the same way.

ASSEMBLY INSTRUCTIONS

CAVEAT

Note: Please tighten the bolts after each installation step.

NO.	PART.	Qty.
M1	 1560mm	1
M2	 1560mm	1
S6		4
S7		4
F2		2

X2

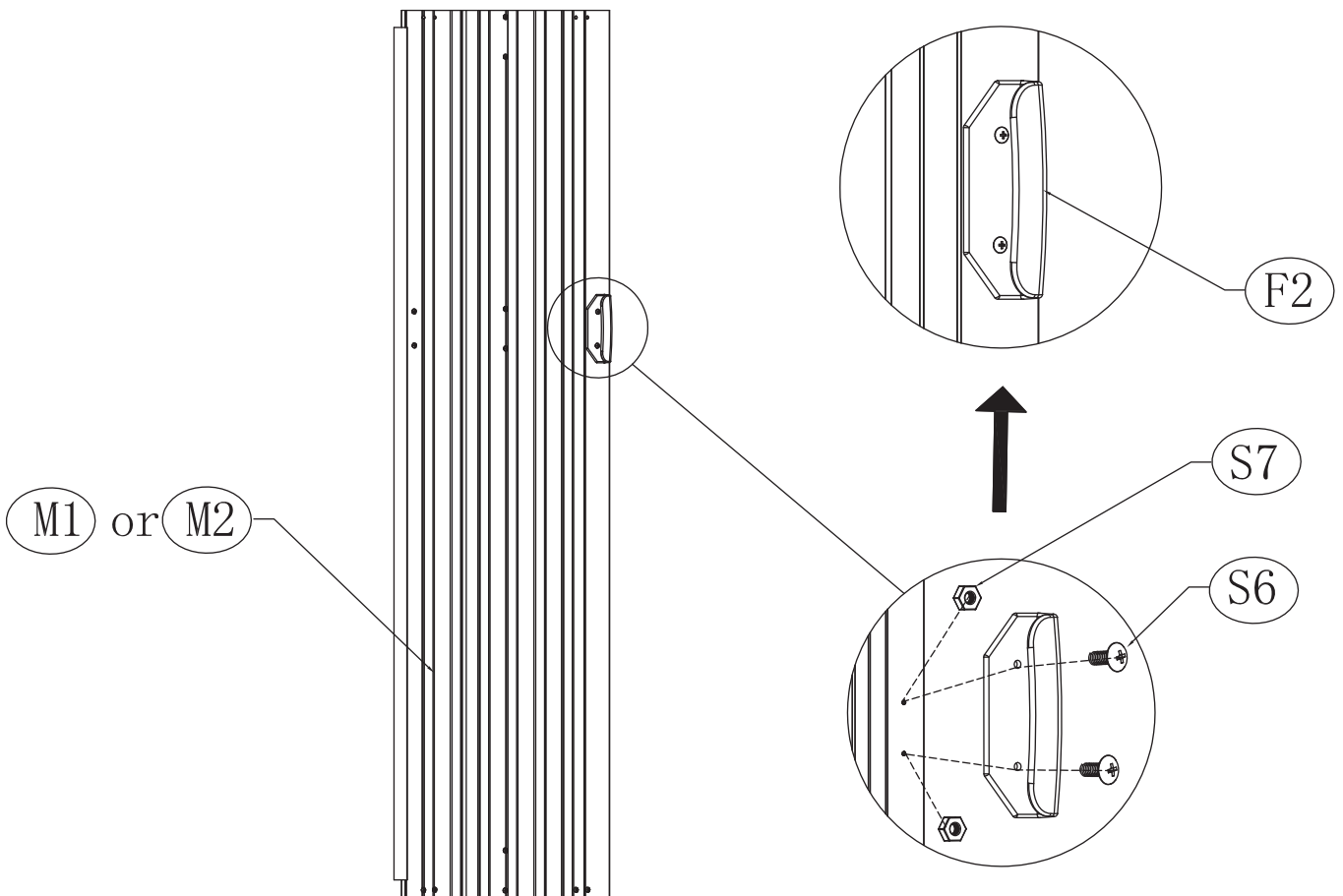

STEP 20

Install the 2 door handles (F2) on the doors (M1&M2) using 4 screws (S6) and 4 nuts (S7).

ASSEMBLY INSTRUCTIONS

 **CAVEAT**

Note: Please tighten the bolts after each installation step.

NO.	PART.	Qty.
S8		8

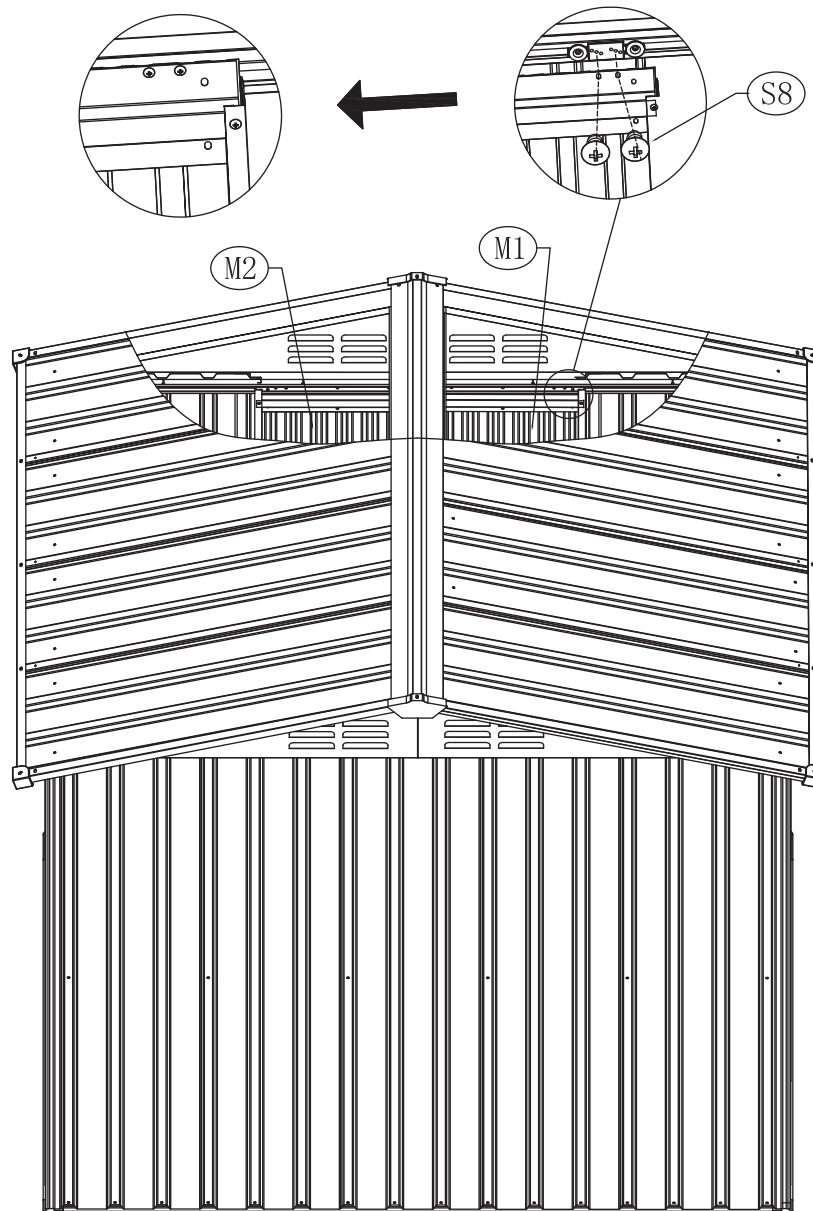

STEP 21

Install 8 screws (S8) on the top of the doors (M1&M2).

ASSEMBLY INSTRUCTIONS



CAVEAT

Note: Please tighten the bolts after each installation step.

NO.	PART.	Qty.
S9		4

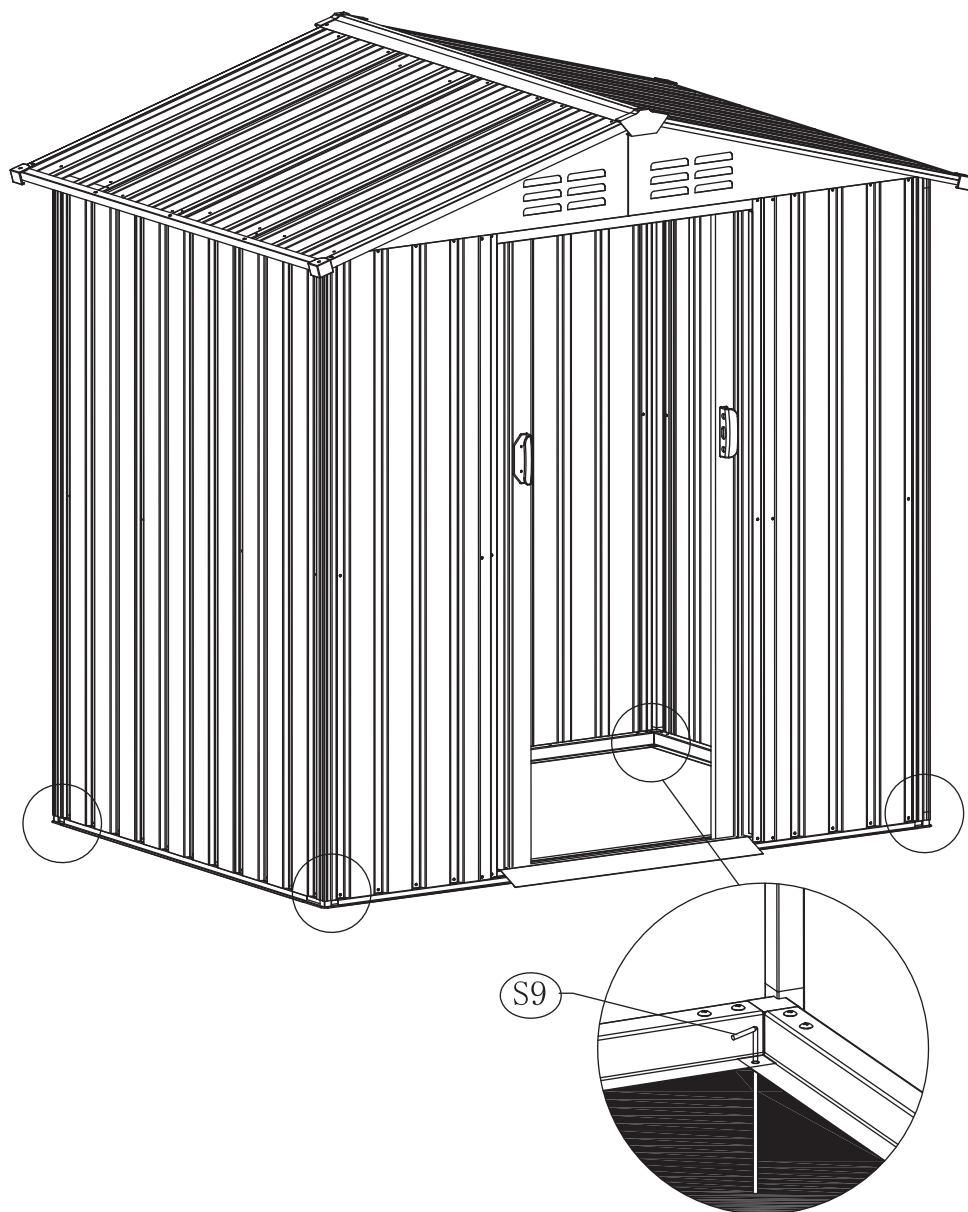

STEP 22

Insert 4 ground spikes (S9) at the four corners of the house.

CARE AND MAINTENANCE

Follow the instructions for the product's material to ensure it stays in the best shape as long as possible. The information below is a general guideline.

Don't hesitate to get in touch with us to learn more.

- Only rinse it thoroughly with clean water to wash away dirt and grime. Never use abrasive cleansers on the furniture since they can attack the surface and leave behind scratch marks.
- For stubborn grime and stains, use a soft sponge and mild soapy water. Then dry it with a cloth or paper towel.
- Check the stability of the screws, nuts, and nut caps before each use. Then, tighten them up after one to two months' use whenever required.
- Avoid improper use, and be careful not to scratch or damage the surface with sharp objects.
- When you move your furniture, lift it rather than pulling or pushing it to avoid damaging the floor, legs, and mounting.

CUSTOMER SERVICE

Thanks for purchasing NUUGARDEN furniture. We are here to help you maximize your enjoyment and appreciation of it.

Please do not hesitate to contact our customer service if you have any questions regarding assembly or accessories.

Add: 6366 Corley Road, Norcross, GA 30071.

Tel: (800) 257-7108

Web: <https://nuumart.com>

E-mail: service@nuugarden.com

Service time: Mon-Fri, 8:30 AM-5:30 PM, EST



NUUGARDEN USA



Nuu Garden Corp.

Add: 6366 Corley Road, Norcross GA 30071.

Tel: (800) 257-7108

Web: <https://nuumart.com>

E-mail: service@nuugarden.com