

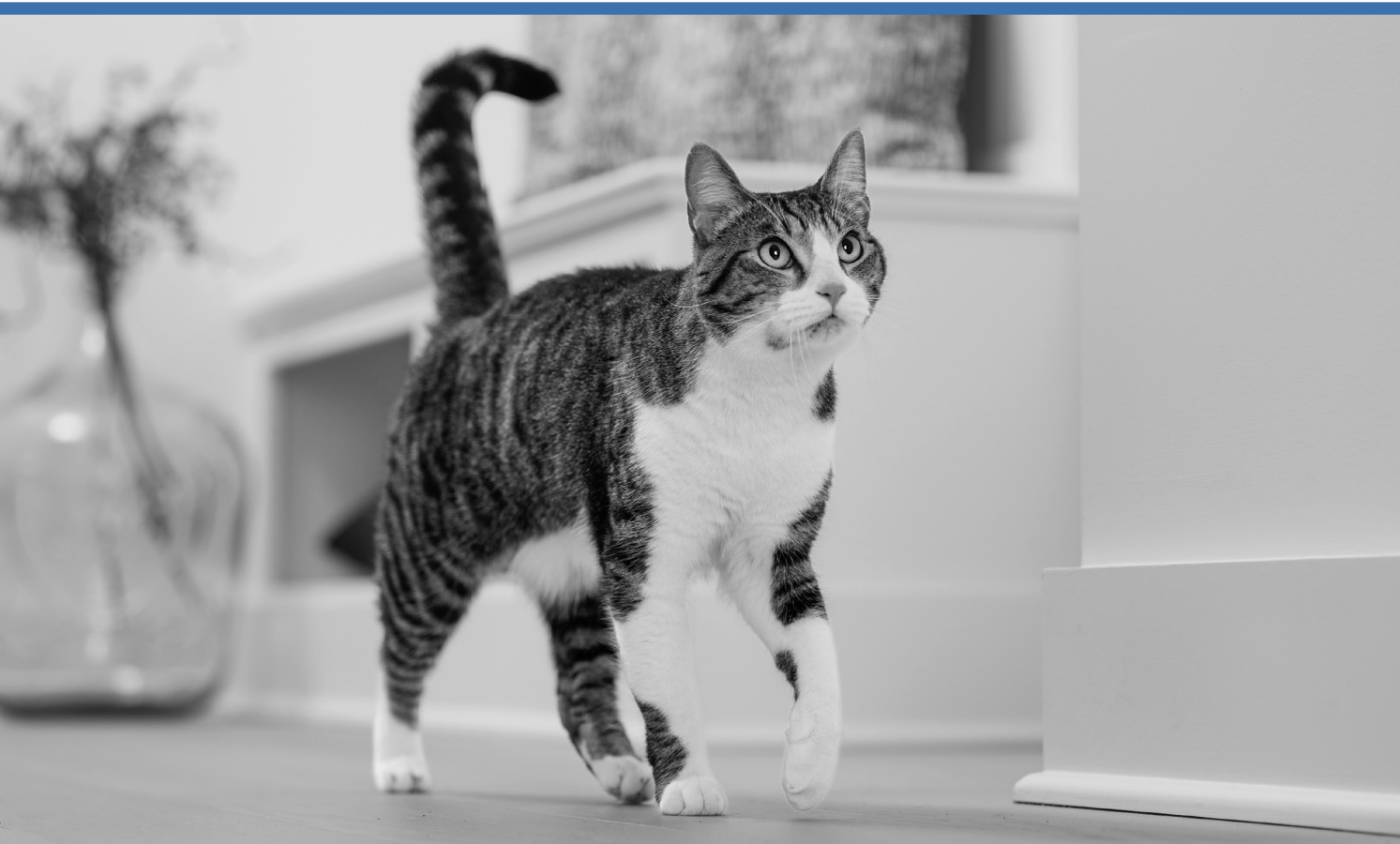

Get Started!



ScoopFree™ SmartSpin™

Self-Cleaning Litter Box

Before we start:

As you set up your new litter box, keep in mind:

Some cats need time to adjust

While many cats take to their new and improved litter box right away, others take a little longer. Here are some tips to help you get off to a good start:

- Place your new ScoopFree™ SmartSpin™ Self-Cleaning Litter Box next to your cat's current litter box. (You'll be able to get rid of the old one soon).
- Let the old litter box get dirty. Most cats prefer a clean litter box and will soon be drawn to the fresh litter.
- Although the ScoopFree™ SmartSpin™ Self-Cleaning Litter Box is quiet when running and only runs after use, in some cases it's a good idea to leave the new litter box unplugged until your kitty gets the hang of it.

Your kitten needs special care

Important: If you have a kitten, leave the litter box unplugged (or turn off the **Auto clean** feature in the app) and scoop waste manually until she is at least 2.5 pounds (1.1 kg) and 6 months old. You may want to place a box or step in front of the litter box to make it easier for her to get in and out.

**Staying connected with your cat
is easier than ever.**

What you have:

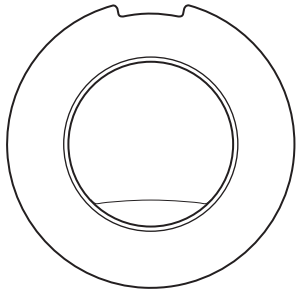

Sphere front

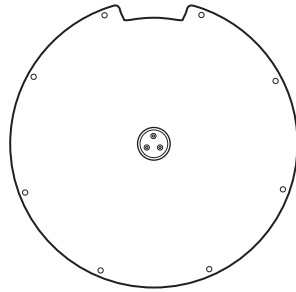

Sphere back

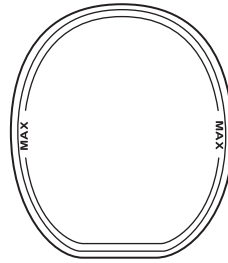

Floor pad

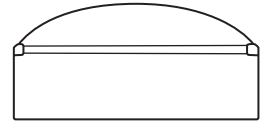

Litter saver

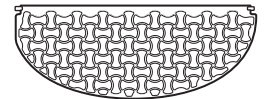

Litter sifter



Cover
(center panel)

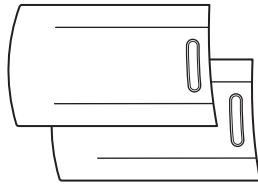

Cover (side panels)

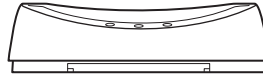

Base

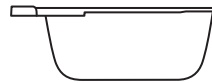

Waste drawer



Bracket



Litter sifter cover



Waste bags

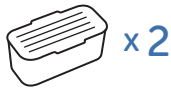

Waste drawer
deodorizers

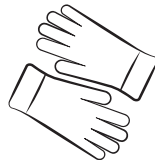

Gloves

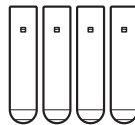

Legs



Red alignment tool



Screwdriver



Screws

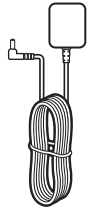

Power adaptor

What you need:

- Wireless router (2.4 GHz)
- High-speed internet connection
- Smartphone

Set up your new litter box

1 Assemble the base

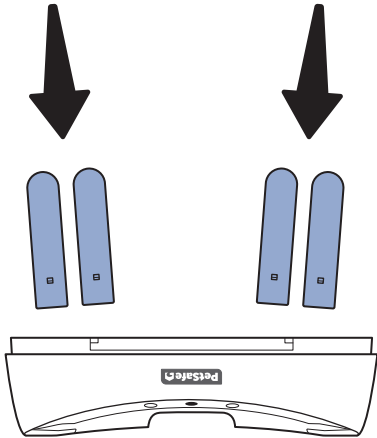

Place the base upside down on the floor or another flat surface. To prevent scratching the top of the base, place a plastic bag from the packaging underneath it.

Insert a leg into one of the four angled holes on the bottom of the base. Press the leg into position, wiggling it back and forth as needed to seat it fully in the hole.

Install the other three legs in the same manner.

2

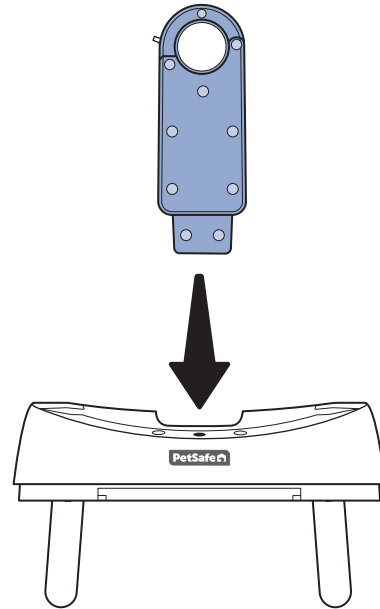

Turn the base right side up and place it on the floor. Make sure the base is sitting level and not wobbling. If you notice any wobbling, adjust the position of the legs until the base is stable.

Insert the bracket into the slot at the rear of the base and press it down to secure it.

3

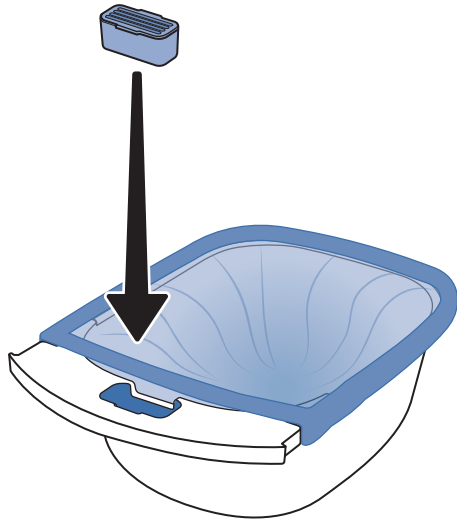

Remove the seal from the waste drawer deodorizer and insert it into the compartment at the front of the waste drawer.

Line the waste drawer with one of the waste bags provided. Secure the front edge of the waste bag in the slots at each side of the waste drawer.

4

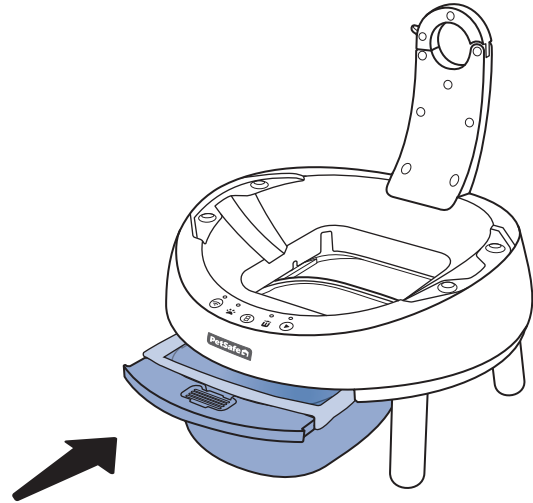

Slide the waste drawer into the base.

5 Assemble the sphere

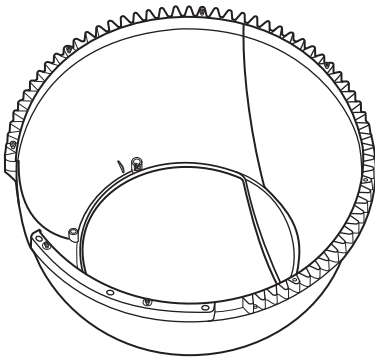

Place the sphere front on the floor or another flat surface. To prevent scratching the sphere front, place a plastic bag from the packaging underneath it.

6

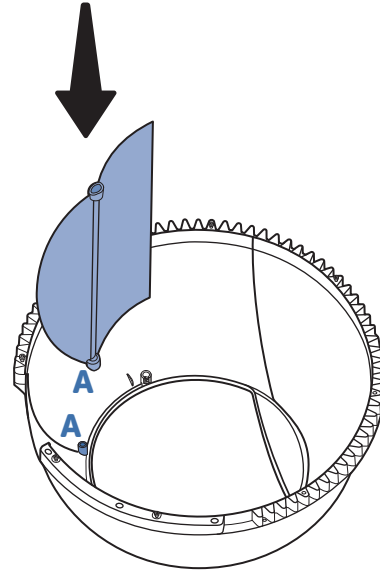

Insert the litter saver into the sphere front, matching the **A** sticker on the litter saver to the **A** sticker on the inside of the sphere front.

The edge of the litter saver should rest behind the corresponding ridge on the inside of the sphere front.

7

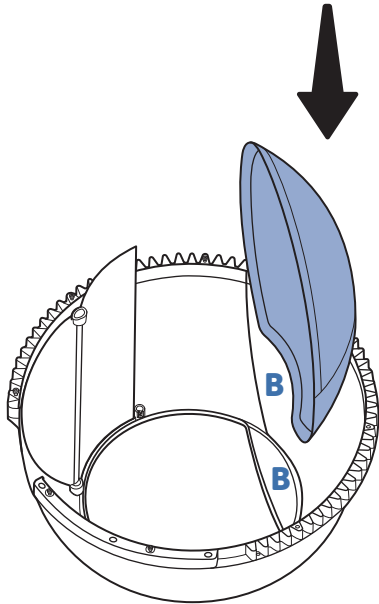

Insert the floor pad into the sphere front, matching the **B** sticker on the floor pad to the **B** sticker on the inside of the sphere front.

The edge of the floor pad should rest behind the corresponding ridge on the inside of the sphere front.

8

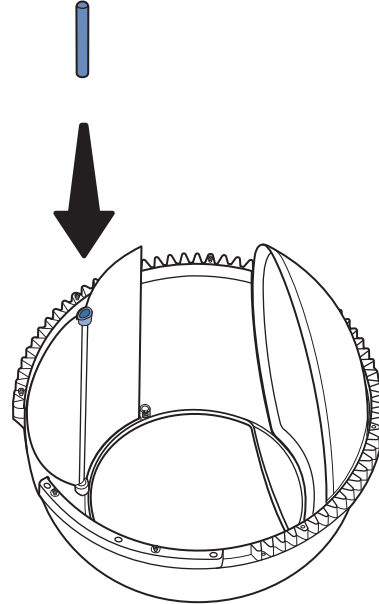

Insert the red alignment tool into the hole at the top edge of the litter saver.

9

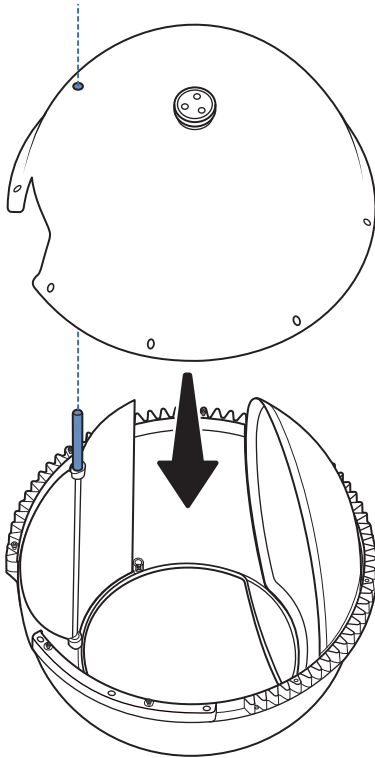

Place the sphere back on the sphere front, making sure the floor pad remains in position and the red alignment tool lines up with the hole in the sphere back.

When the sphere back is placed correctly, the red alignment tool should protrude through the hole in the sphere back, the cutouts in the sphere halves should line up with one another (as shown in the following illustration), and the floor pad should be held in position by ridges inside the sphere halves.

10

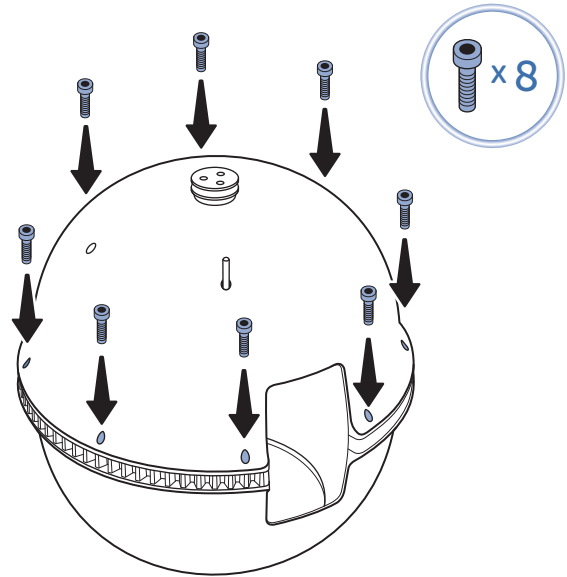

Secure the two halves of the sphere together using the screwdriver and 8 screws provided.

Start with the first screw, then move to the one on the opposite side, working your way in a criss-cross pattern until all screws are secure. This method will ensure a better fit than installing the screws sequentially around the edge.

Once you are satisfied that the sphere halves are fit together correctly with no gaps, remove the red alignment tool and set it aside for future use.

11 Install the litter sifter

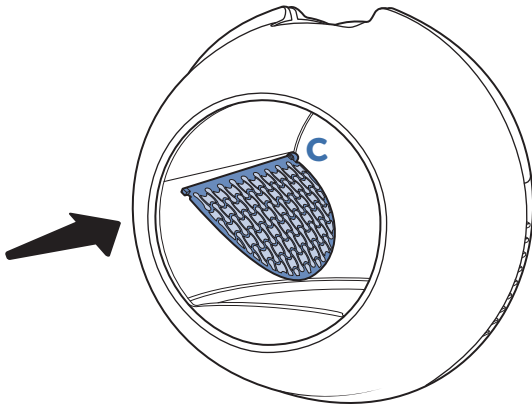

Position the assembled sphere with the large opening at the front.

Insert the post at the back of the litter sifter (marked with a **C** sticker) into the hole at the back of the sphere (also marked with a **C** sticker).

12

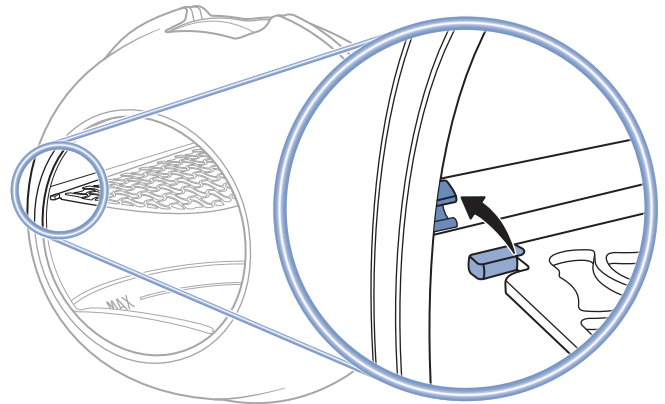

Rotate the front of the litter sifter upward and snap it into the clip at the front of the sphere.

The litter sifter is now installed.

13 Place the sphere on the base

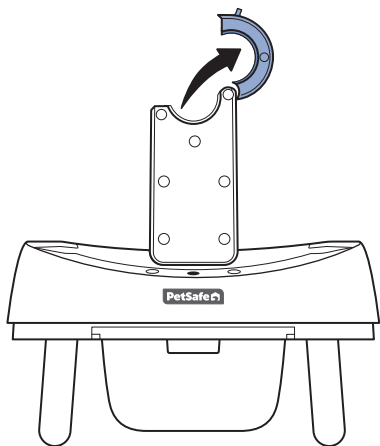

On the base, open the latch at the top of the bracket.

14

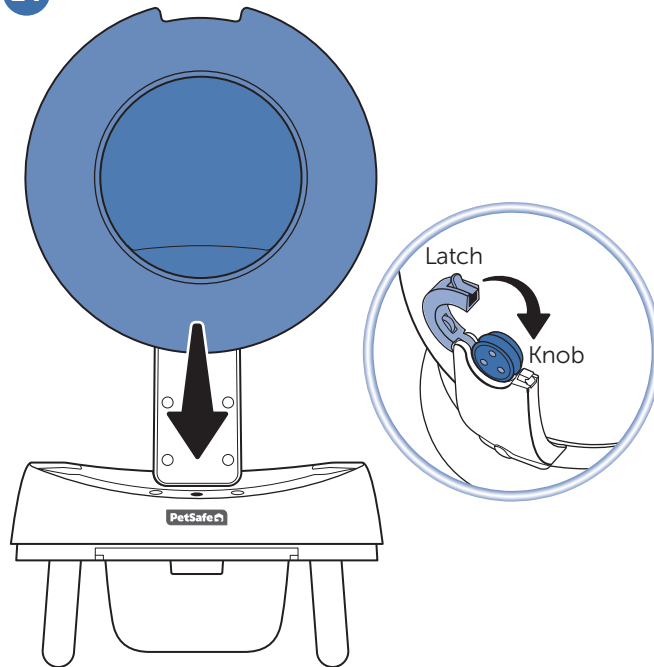

Place the assembled sphere on the base, positioning the knob on the back of the sphere within the latch you just opened.

Close the latch around the knob to secure the sphere to the base.

15 Assemble the cover

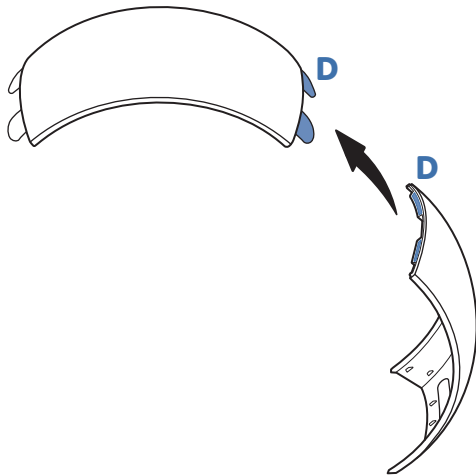

The cover is made up of three panels: one center panel and two side panels.

Line up the **D** sticker on one of the side panels with the **D** sticker on the center panel. Connect the center panel to the side panel by inserting the tabs on the center panel into the corresponding slots on the side panel.

16

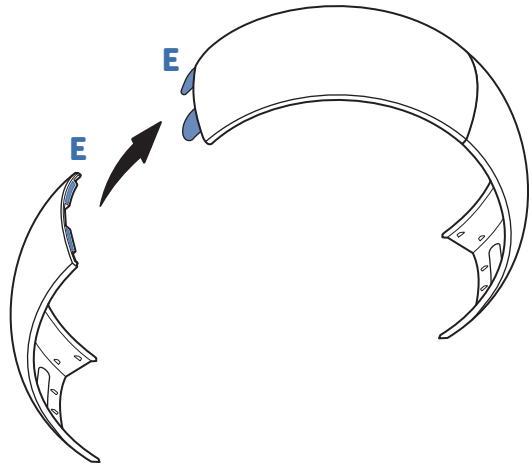

Line up the **E** sticker on the remaining side panel with the **E** sticker on the center panel. Connect the center panel to the side panel by inserting the tabs on the center panel into the corresponding slots on the side panel.

The cover is now assembled.

17 Install the cover

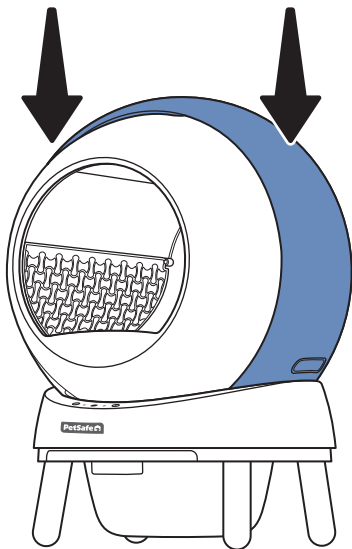

Place the cover down over the sphere, making sure the arrows on the sticker are facing the front of the litter box.

When placed correctly, the magnets at the bottom of each side of the cover will connect with magnets on the base.

18 Plug in the litter box

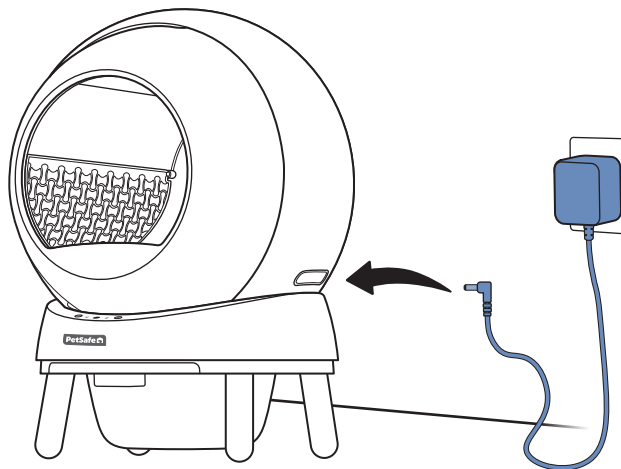

Place the assembled litter box in a clean, dry location near an electrical outlet and within range of your home's Wi-Fi.

Connect the small end of the power adaptor to the power jack on the back of the litter box base (to the right of the bracket).

Important: If you have a kitten, leave the litter box unplugged (or turn off the **Auto clean** feature in the app) and scoop waste manually until she is at least 2.5 pounds (1.1 kg) and 6 months old.

Make sure there is nothing inside the litter box, then plug the other end of the power adaptor into an electrical outlet.

The litter box will power on and begin a self-check program. After 10 seconds, the sphere will rotate 180 degrees. About 2 minutes later, the sphere will return to its starting position, indicating the self-check is complete.

19 Add litter

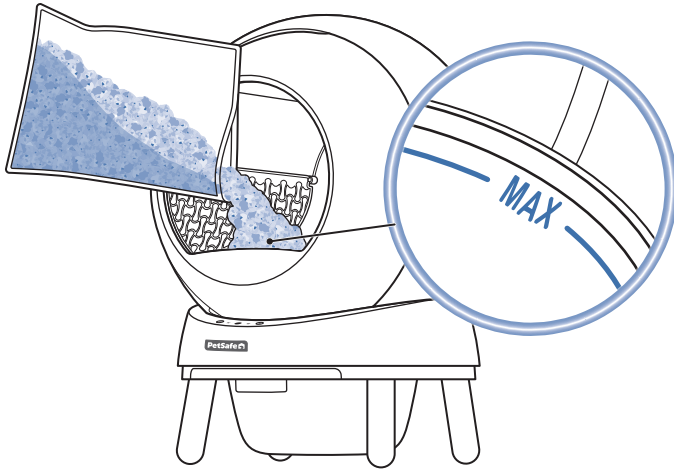

Press and hold the cleaning button (▶) for 3 seconds to enter Add Litter mode. The numeric status display will display an **A** to indicate the litter box is in Add Litter mode. (Use this mode every time you add fresh litter to the litter box.)

Fill the litter box with your cat's favorite cat litter up to the **MAX** fill line.

Important: Do not fill the litter box beyond the **MAX** fill line. Litter with larger pellets, such as tofu litter, may not be compatible with the litter box.

Press and release the cleaning button to exit Add Litter mode. The litter box will calibrate to the current weight of the litter.

Important: If you add litter without entering Add Litter mode, you will need to power cycle the litter box to calibrate it to the new weight of the litter.

20 Download the app and connect



Scan the QR code above to download the ScoopFree Litter Box app.

Once you have downloaded and opened the app, press and hold the Wi-Fi button (📶) on the litter box for 3 seconds to enter pairing mode. The Wi-Fi light will begin blinking.

In the app, follow the on-screen instructions to add the litter box to the app and connect it to your Wi-Fi network.

When the litter box is connected, the Wi-Fi light will glow solid.

How the litter box works

Once you've connected the litter box to the app, it's ready to use. Here's how it works:

- A weight sensor inside the litter box recognizes when your cat is present. The cat entry light will illuminate when a weight change of more than 2.5 pounds (1.1 kg) is detected.
- When your cat leaves the litter box, the cat entry light will turn off, the cleaning light will begin blinking, and the cleaning timer will start a 7-minute countdown. (You can change the length of this countdown in the app.)
- When the countdown is complete, the litter box will start the cleaning cycle. The sphere will slowly rotate 180 degrees. As the sphere rotates, unused litter will fall through the litter sifter and be stored behind the litter saver. Clumped litter and waste will remain on top of the litter sifter and be deposited into the waste drawer. The sphere will then rotate back to its starting position, spreading the unused litter evenly across the bottom of the litter box.
- If your cat returns to the litter box during the countdown, the timer will stop. The countdown timer will reset when your cat leaves the litter box again.
- You can start the cleaning cycle at any time by pressing the cleaning button for 1 second. To pause the cleaning cycle, press the cleaning button again. (You can also start and stop the cleaning cycle in the app.)

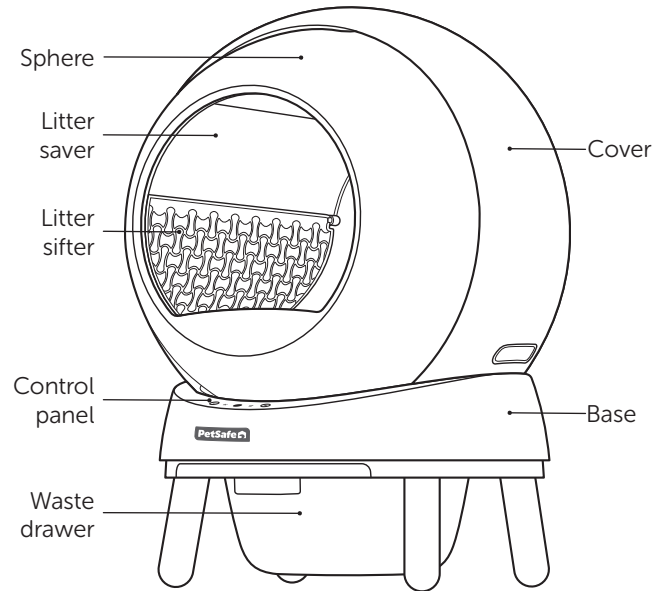

Control panel lights and buttons

The lights and buttons on the litter box control panel provide system status and allow you to control some litter box functions:

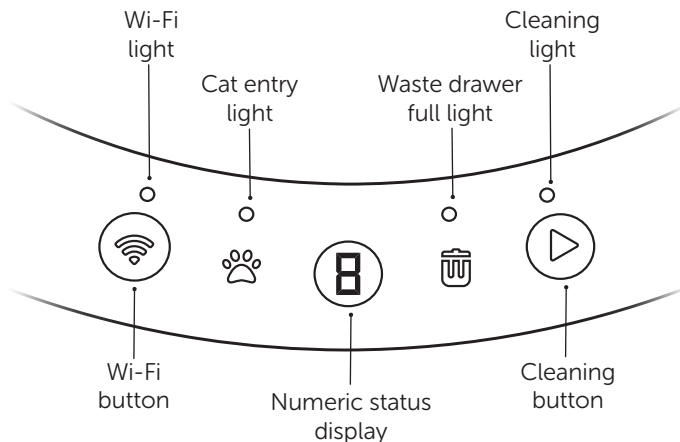

Button	Usage
Wi-Fi button	Press and hold this button for 3 seconds to enter pairing mode.
Cleaning button	Press the cleaning button for 1 second to manually start the cleaning cycle. To pause or resume the cleaning cycle while it is in progress, press the cleaning button again. Press and hold the cleaning button for 3 seconds to enter Add Litter mode. After adding litter to the litter box, press the cleaning button again to exit Add Litter mode.

Light	Meaning
Wi-Fi light	<ul style="list-style-type: none"> Solid white: The litter box is connected to Wi-Fi. Blinking white: The litter box is not connected to Wi-Fi.
Cat entry light	<ul style="list-style-type: none"> Solid white: A weight change of more than 2.5 lb (1.1 kg) has been detected. Off: No weight change has been detected.
Waste drawer full light	<ul style="list-style-type: none"> Solid white: The waste drawer is full. Off: The waste drawer is not full.
Cleaning light	<ul style="list-style-type: none"> Solid white: The cleaning cycle is in progress. Blinking white: The cleaning cycle countdown has been initiated.
Numeric status display	<p>This display provides information about the litter box operating mode and alerts you to any error conditions:</p> <ul style="list-style-type: none"> A: Add Litter mode is enabled. L: Child lock is enabled; the control panel buttons are locked. P: Sleep mode is enabled; the litter box will not run the cleaning cycle during the selected time period. 1: The infrared sensor in the base is blocked. 2: The cover is not installed. 3: Abnormal motor current. 4: Sphere not installed. <p>See the app for more information about litter box operating modes and error conditions.</p>

Empty the waste drawer and add fresh litter

You can expect to empty the waste drawer about once a week for one cat, twice a week for two cats, or every few days for three or more cats. When the waste drawer is full, you will receive a notification in the app and the waste drawer full light  will illuminate.

1

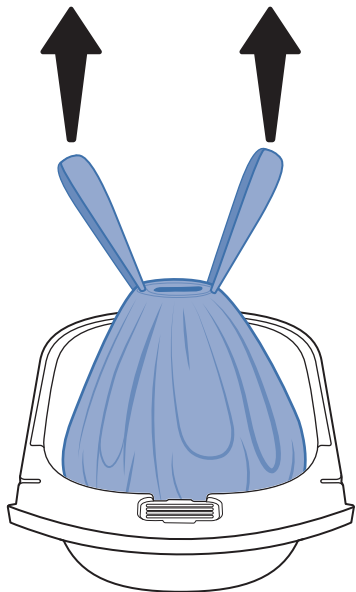

Important: See the customer care guide for safety instructions related to cat litter waste and toxoplasmosis.

Remove the waste bag from the waste drawer, tighten the drawstring, and place the waste bag in the trash.

If desired, remove and replace the waste drawer deodorizer.

Line the waste drawer with a fresh waste bag, making sure to secure the edges and press down the center of the waste bag so it won't block the litter box sensors. Slide the waste drawer back into the litter box base.

2

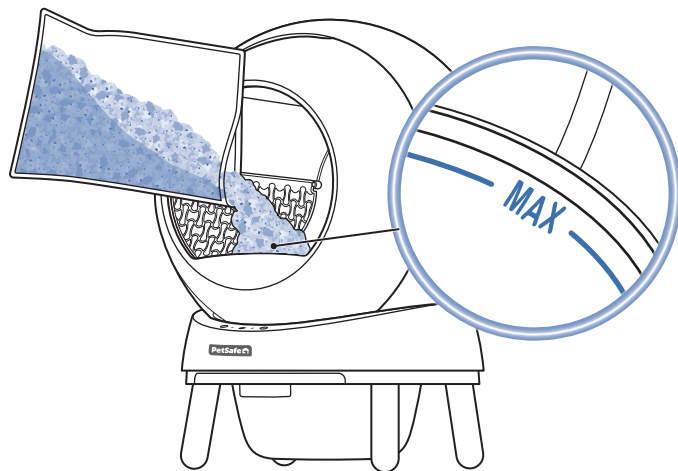

Press and hold the cleaning button  for 3 seconds to enter Add Litter mode. The numeric status display will display an **A**.

Refill the litter box with fresh cat litter up to the **MAX** fill line.

Press the cleaning button again to exit Add Litter mode. The litter box will calibrate to the current weight of the litter.

Clean the litter box

When it's time to give the litter box a deeper cleaning:

1

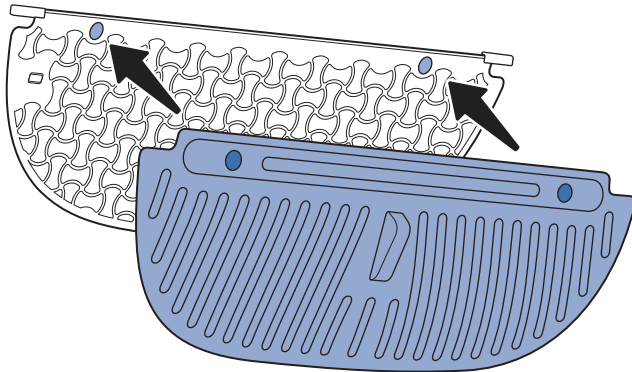

Attach the litter sifter cover to the litter sifter and then press the cleaning button. The sphere will rotate and deposit all of the litter into the waste drawer. Remove the litter sifter cover, wash it with warm soapy water, and set it aside for future use.

Remove the waste bag from the waste drawer, tighten the drawstring, and place the waste bag in the trash.

Remove the waste drawer deodorizer. Wash the waste drawer with warm soapy water.

2

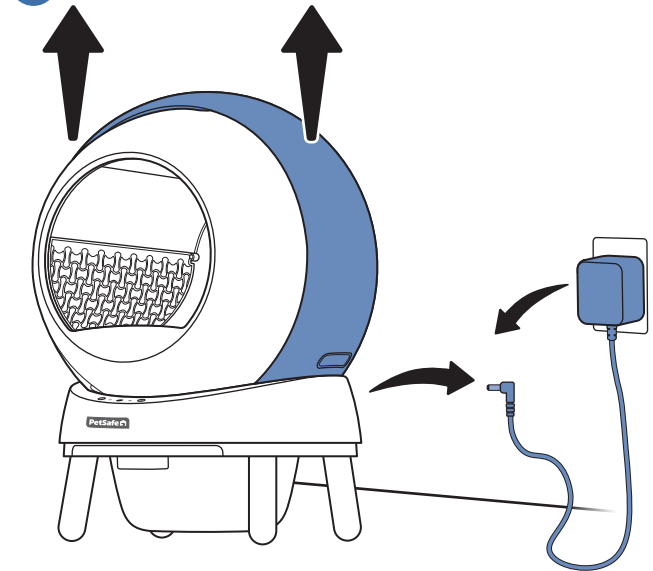

Unplug the litter box and disconnect the power adaptor.

Remove the cover.

Important: When replacing the cover, make sure the arrows on the sticker (or etched inside the cover) are facing the front of the litter box. The cover may break if placed on the litter box backward.

3

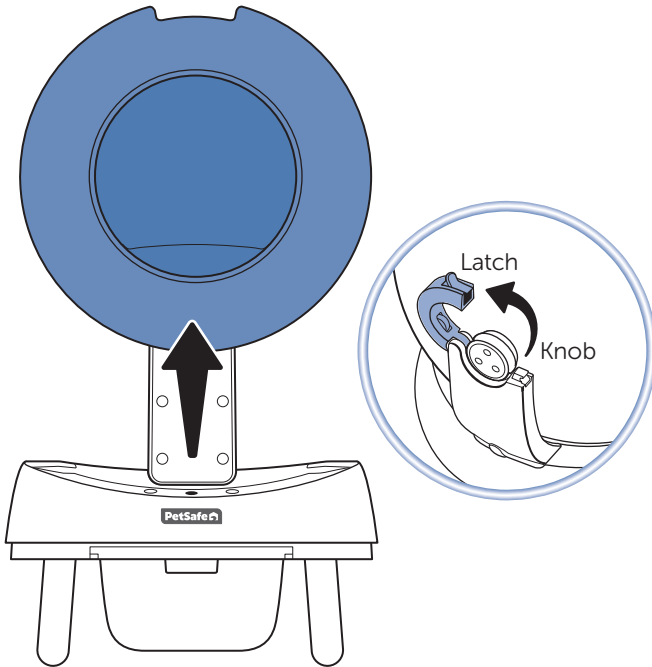

Open the latch at the back of the sphere.
Lift the sphere off the base.

4

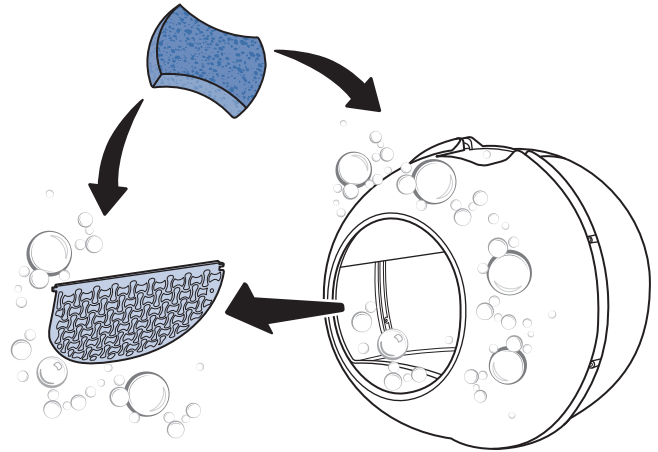

Remove the litter sifter from the sphere and wash it with warm soapy water.

Using a cloth or sponge, mild soap, and water, wipe the interior and exterior surfaces of the sphere.

Important: Do not use bleach or chemicals to clean; the odor may repel your cat.

If further cleaning is needed, disassemble the sphere and wash the sphere halves, floor pad and litter saver with warm soapy water.

5

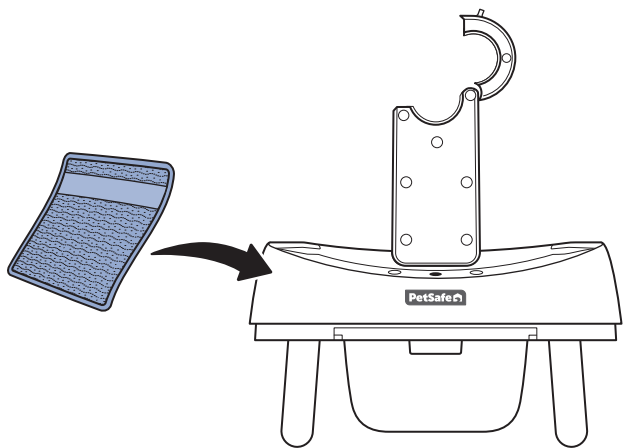

Important: The base contains the litter box's electronic components and is not waterproof. Do not rinse the base, submerge it in water, or spray it with any cleaning solutions.

Use a dry or very slightly damp cloth to wipe the base.

6

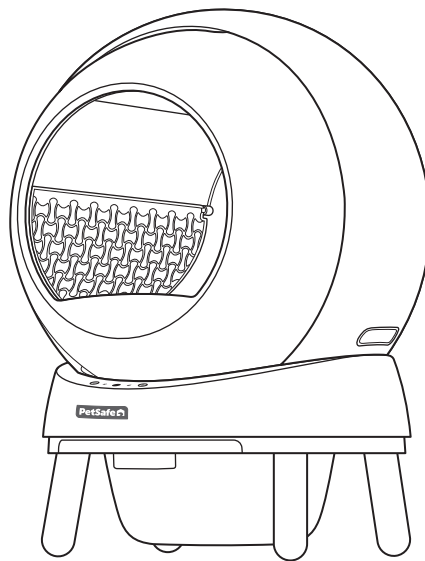

Allow all components to dry thoroughly before reassembling the litter box.

Important: When replacing the cover, make sure the arrows on the sticker (or etched inside the cover) are facing the front of the litter box. The cover may break if placed on the litter box backward.

ScoopFree™ SmartSpin™

Self-Cleaning Litter Box



We're here to help!

For questions or additional tips:
support.petsafe.com

1-Year Limited Warranty | ©2025 Radio Systems Corporation | Models: PAL00-17985, PAL00-18160 | 400-2638/1
For important safety instructions, please see the customer care guide.