



1½" Self-Priming Centrifugal Pump

Model: SE1½AL-G.5C

Price Code: P-58-11A4-G.5C

Driver: Leeson 60Hz Electric Motor (.5 HP) Single Phase

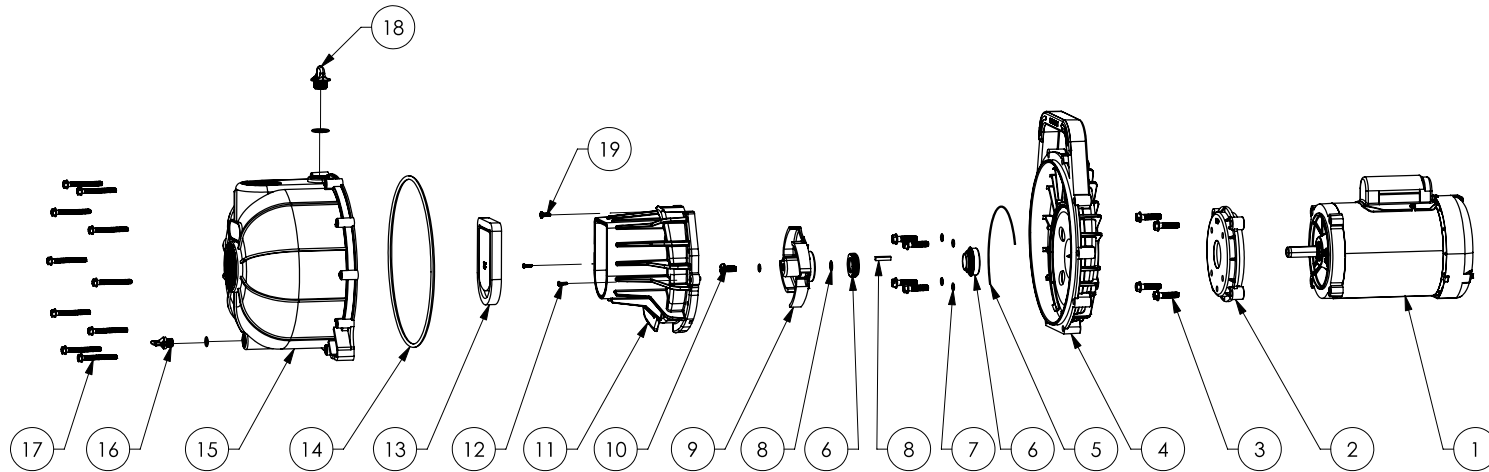
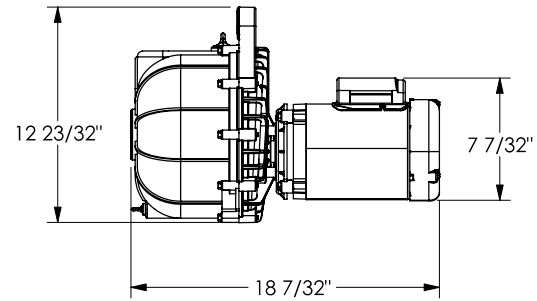
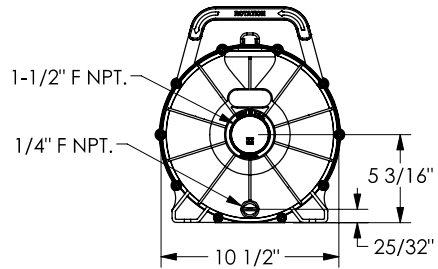



1½" Self-Priming Centrifugal Pump

Model: SE1½AL-G.5C

Price Code: P-58-11A4-G.5C

Driver: Leeson 60Hz Electric Motor (.5 HP) Single Phase

NO.	DESCRIPTION	QTY	PART NO.
1	Leeson .5 HP Electric Motor 1Φ	1	58-0818-C
2	C-Face Adapter PPE	1	58-1010-20A
3	Mounting Screw SS 5/16-24x1 1/4"	4	58-1015-10
4	Bracket PET	1	58-0703-30B
5	O-Ring Segment EPDM	1	58-0754-72
6	Shaft Seal EPDM, SS 316, carbon/ceramic 3/4"	1	58-0714-12
7	Bracket Screw and O-Ring SS EPDM 5/16-24x1 1/4"	4	58-0715-12
8	Key & Shim SS 3/16" Square x 15/16" Long	1	58-0778S
9	Impeller PET 3 Vane, .535" Wide, ø5.5"	1	58-0704-30
10	Impeller Screw and O-Ring SS EPDM 5/16-24x3/4"	1	58-0716-12
11	Volute Flat PET	1	58-0954-30
12	Volute Side Screw SS 6-CCx1/2"	2	58-0725-10
13	Check Valve EPDM	1	58-0705-72
14	Body O-Ring EPDM	1	58-0719-72
15	Body PET, black 1½" F NPT.	1	58-1001-30B
16	Drain Plug and O-Ring PET EPDM	1	58-0723-32
17	Body Bolt SS 18-8 1/4-20x2.125"	10	58-1206-10
18	Filler Plug and O-Ring PET EPDM	1	58-0722-32B
19	Volute Top Screw SS 10-24x1-1/2"	1	58-0997-10