

Fire Pit Instruction Sheet

Model Numbers:
12VP • 15VP • 19VP

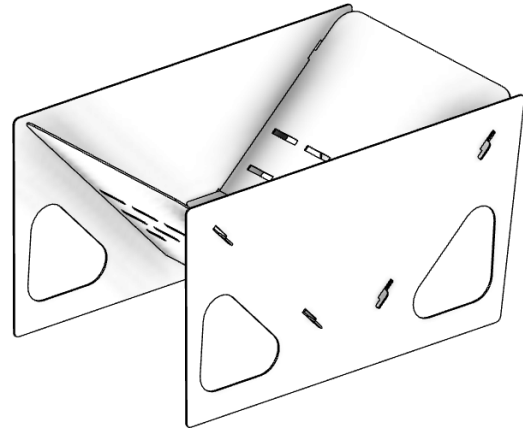

854283 rev A

Align the two hooked tabs on the side panel with the designated slots on the back panel. Firmly insert the tabs into the slots until fully secured.

Repeat the alignment process with the front panel, positioning its slots with the corresponding hooked tabs on the same side panel.

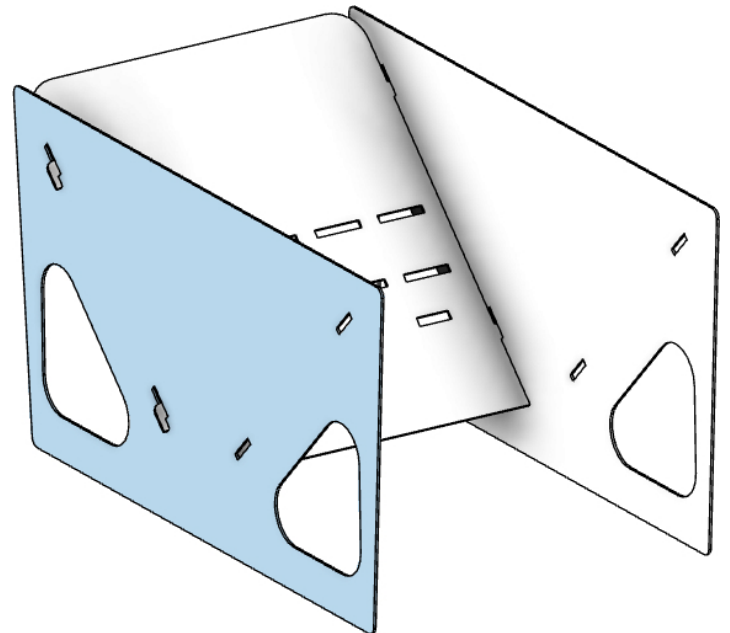
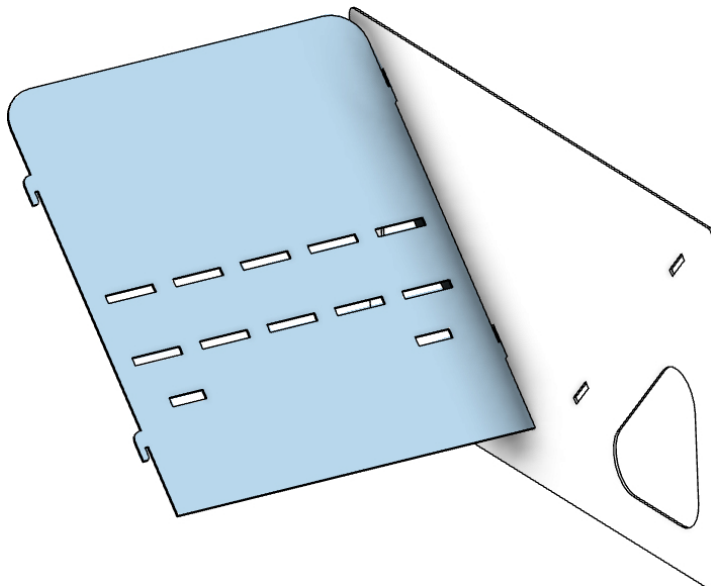
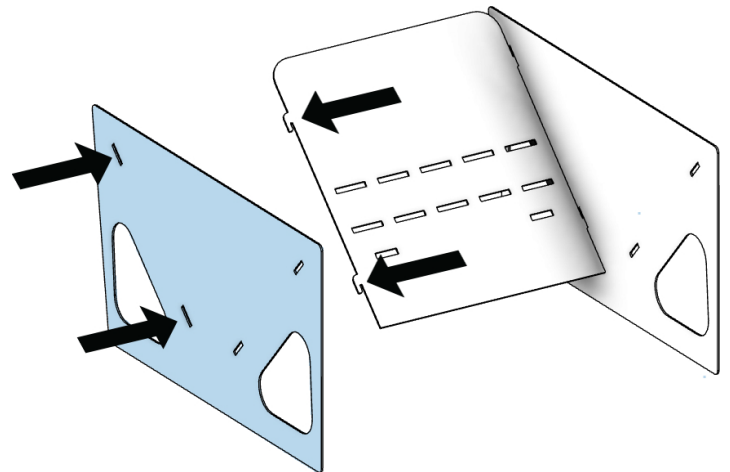
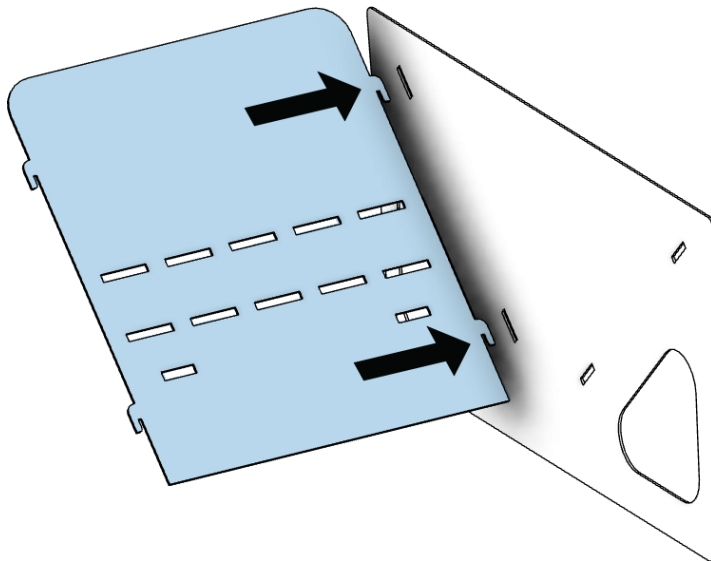

ASSEMBLY

Position the second side panel on the opposite end of the fire pit. Carefully align its four hooked tabs with the slots on both the front and back panels. Press firmly to insert and lock all tabs in place.

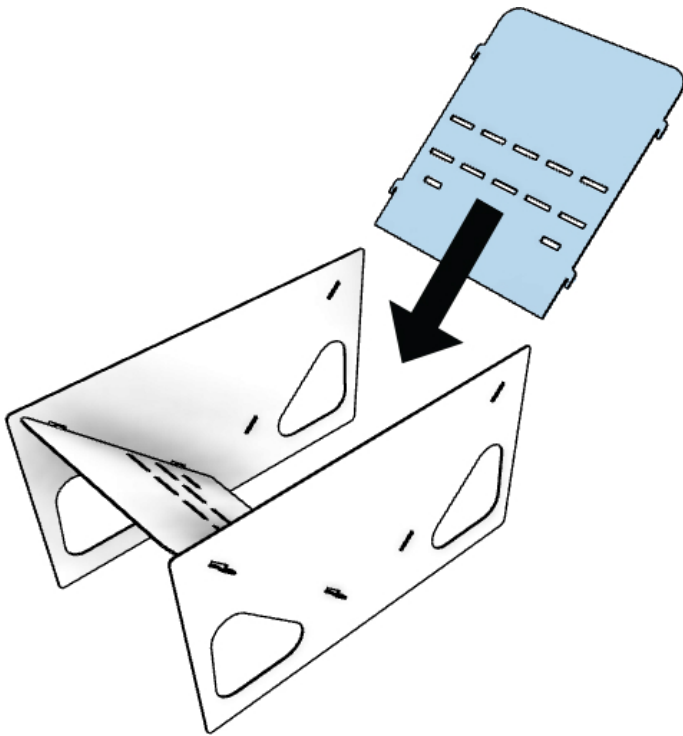

Locate the two tabs on the grate. Align these with the designated openings on the side panels, then lower the grate into position so it rests flat inside the fire pit.

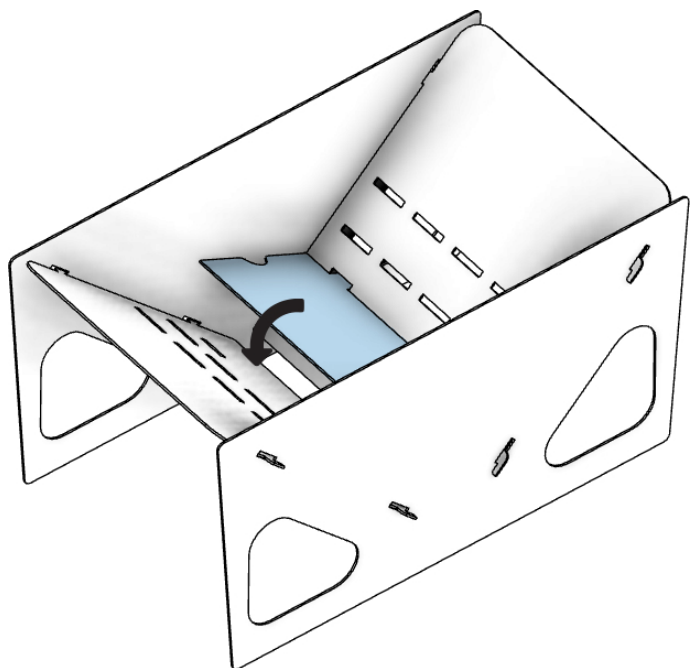
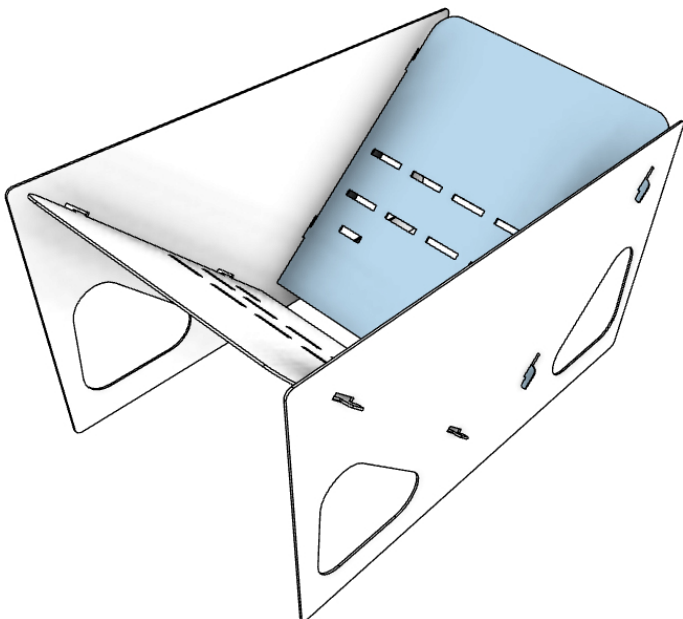
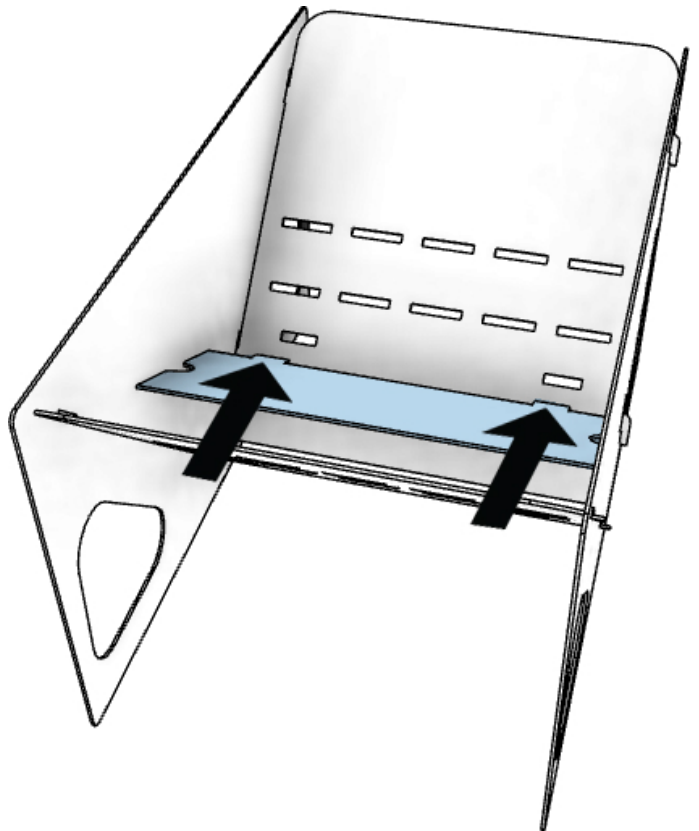

ASSEMBLY

WANT TO GIVE YOUR NEW FIRE PIT THAT AGED, RICH, RUSTY PATINA? HERE'S HOW!

Ingredients:

- 16 oz. Hydrogen Peroxide (Use Fresh Bottle for best results)
- 2 oz White Vinegar
- ½ Tbsp Salt

Use rubber gloves and safety goggles!

1. Mix the above ingredients in a clean spray bottle. Mix well to ensure the salt has fully dissolved.
2. Clean the fire pit thoroughly (all sides) with a good degreaser to remove any oil or dirt from the surface. NOTE: This step is not necessary but will give the best results. Allow the parts to dry completely.
3. You may assemble the fire pit or for an even patina, lay each of the metal pieces on a flat surface, then apply the solution to one side at a time.
4. Apply your first coat by lightly misting the solution over the entire surface of each part. Allow this coat to dry. You will see the rust begin to form within the first few minutes of application. Continue to apply the solution, allowing it to dry between applications until you have achieved the desired patina.
5. Allowing the solution to puddle or run will give different patterns. Happy Rusting!

OTHER FINISHING OPTIONS

- Painted- Paint using a high temperature grill paint in a well ventilated area.
- Raw- If no finish is desired, regularly applying a thin coat of cooking oil will reduce rusting.

SAFETY WARNINGS

BEFORE USING THIS OUTDOOR FIRE PIT, MAKE SURE YOU HAVE READ, UNDERSTAND, AND ARE FOLLOWING ALL OF THE SAFETY INFORMATION PROVIDED BELOW. FAILURE TO FOLLOW THOSE INSTRUCTIONS CAN CAUSE DEATH, SERIOUS INJURY, AND/OR PROPERTY DAMAGE.

1. This appliance is for outdoor use only, and shall NOT be used in a building, garage, or any other enclosed area.
2. Always use this outdoor fire pit on a hard, level non-combustible surface such a concrete, rock or stone. An asphalt or blacktop surface may not be acceptable for this purpose. Do NOT use on wooden decks.
3. Do NOT use this outdoor fire pit for indoor heating. TOXIC carbon monoxide fumes can accumulate and cause asphyxiation.
4. This outdoor fire pit is NOT for commercial use.
5. This outdoor fire pit is NOT to be operated by children.
6. This outdoor fire pit is NOT to be used in or on boats or recreational vehicles.
7. Always use in accordance with all applicable local, state and national codes. Contact your local fire department for details on outdoor burning.
8. When using this outdoor fire pit, exercise the same precautions you would with any open fire.
9. The use of alcohol, prescription or non-prescription drugs may impair the consumer's ability to properly assemble or safely operate this outdoor fire pit.
10. Do NOT store or use gasoline or other flammable vapors or liquids in the vicinity of this or any other appliance.
11. Do NOT store or use an LP gas cylinder within 10 feet (3.05 m) of this outdoor fire pit while it is in operation.
12. Do NOT use this outdoor fire pit near automobiles, trucks, vans or recreational vehicles.
13. Do NOT use in an explosive atmosphere. Keep outdoor fire pit area clear and free from combustible materials, gasoline and other flammable liquids.
14. Do NOT use this outdoor fire pit under any overhead or near any unprotected combustible constructions. Avoid using near or under overhanging trees and shrubs.
15. Do NOT wear flammable or loose clothing when operating this outdoor fire pit.
16. Use gloves while assembling, disassembling, or moving this fire pit.
17. Always disassemble the fire pit before moving. Do NOT move the fire pit without first disassembling it.
18. Do NOT move or store this outdoor fire pit until the fire is COMPLETELY out and the fire pit has COMPLETELY cooled.
19. To avoid muscle strain or back injury, use lifting aids and proper lifting techniques when assembling, disassembling, or moving this fire pit.
20. Do NOT use in windy conditions.
21. Do NOT use gasoline, kerosene, diesel fuel, lighter fluid or alcohol to light or relight fires.
22. Keep all electrical cords away from a hot fire pit.
23. All surfaces of this outdoor fire pit are hot when in operation. To avoid burns, do NOT touch fire pit until it has completely cooled unless you are wearing protective gear (Potholders, gloves, BBQ mittens, hot pads & etc.). Never touch ashes or coals to see if they are hot.
24. Do NOT leave a lit outdoor fire pit unattended, especially around children and pets
25. Do NOT attempt to move or store this outdoor fire pit until all ashes and coals are completely extinguished.
26. Do NOT remove ashes or coals until they are completely and fully extinguished.
27. Do NOT overload the fire pit. Do not add additional firewood until the fire burns down. NOTICE: If any portion of the of this outdoor fire pit are glowing red it is overloaded.
28. Do NOT lean over this outdoor fire pit when lighting or when in use.
29. Avoid breathing smoke from the fire and avoid getting it into your eyes.
30. You need two people to properly and safely assemble this fire pit. The fire pit is heavy and could be hard to handle for a single person. Please exercise caution when assembling this fire pit.
31. Deaths, serious injury or damage to property may occur if the above is not followed exactly.