

### 150 PSI Oil-Free 10 Gallon Tank Air Compressor OPERATOR'S MANUAL

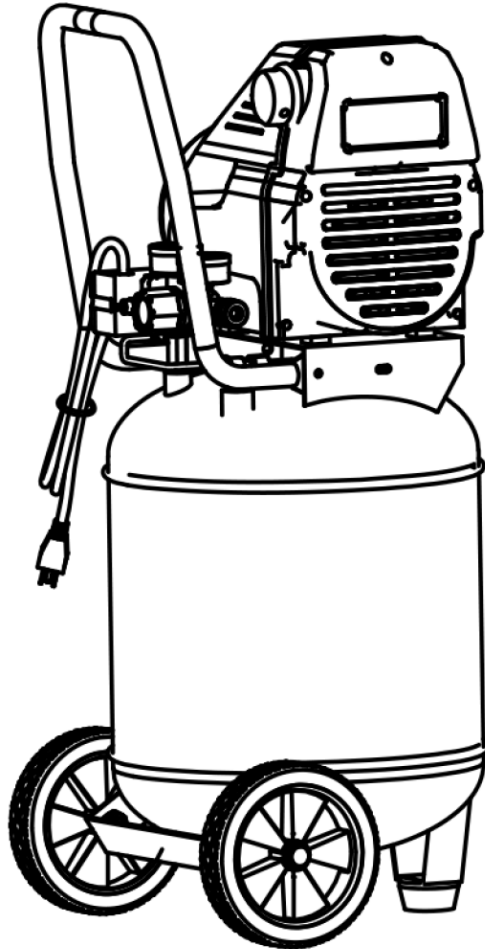

#### Caution:

- Before using your air compressors, please read this manual carefully to understand the proper use of your unit
- Keep this manual handy



**WARNING:** This product and dust created by its use may contain chemicals, including lead, known to the State of California to cause cancer, birth defects, or other reproductive harm. Wash hands after handling. For more information, visit [www.P65warnings.ca.gov](http://www.P65warnings.ca.gov).

	<b>DO NOT RETURN TO STORE!</b>
	HAVE QUESTIONS OR NEED SERVICE?
1-866-591-8921	<a href="mailto:support@pulsar-products.com">support@pulsar-products.com</a>

# Table of Contents

Table of Contents .....	1	Maintenance .....	7
Introduction .....	1	Troubleshooting Guide .....	9
Safety Warnings and Notices .....	1	Specifications .....	10
Safety Instructions .....	2	Exploded View .....	11
Preparation & Installation.....	5	Parts List.....	12
Operation.....	6		

## Introduction

Thank you for choosing this Goodyear Air Compressor.

This manual provides instructions on operating and using your air compressor safely and correctly; be sure to read and understand this manual before using your air compressor. If you have **ANY questions**, please phone **1.866.591.8921** or email **support@pulsar-products.com** **BEFORE** using your air compressor.

All details and images in this Operator's Manual are believed to be accurate at publication.

This manual is a permanent part of the air compressor set. If the air compressor is resold, kindly include this manual with the air compressor.

## Safety Warnings and Notices

### WARNING: Save This Manual for Future Reference

This manual contains important information regarding the safety, operation, maintenance, and storage of this product. Before use, read are fully and understand all cautions, warnings, instructions, and product labels. Failure to do so could result in serious personal injury and/or property damage

## Safety Definitions

This manual contains important information regarding the safety, operation, maintenance, and storage of this product. Before use, read are fully and understand all cautions, warnings, instructions, and product labels. Failure to do so could result in serious personal injury and/or property damage.

 This safety alert symbol appears with most safety statements. It means to pay attention and be alert, your safety is involved! Please read and abide by the message that follows the safety alerts symbol.

### DANGER

DANGER indicates an imminently hazardous situation which, if not avoided, will result in death or serious injury.

### WARNING

WARNING indicates a potentially hazardous situation which, if not avoided, could result in death or serious injury.

### CAUTION

CAUTION indicates a potentially hazardous situation which, if not avoided, may result in minor or moderate injury. It may also be used to alert against unsafe practices.

### NOTICE

Failure to follow the instruction may result in the damage to your air compressor and other property.

# Safety Instructions

## Hazard Warnings

### **WARNING**









This product may expose you to chemicals, including lead and DEHP, which are known to the State of California to cause cancer, birth defects, or other reproductive harm. Wash your hands thoroughly after handling. For more information, visit [P65Warnings.ca.gov](http://P65Warnings.ca.gov).

Improper operation or maintenance of this product may result in serious injury and/or property damage. Please read and fully understand all warnings and safety instructions provided before using this equipment.

### **NOTICE**

The air compressor must be operated on a dedicated 20-amp circuit. If the circuit cannot support the load or if a circuit breaker trips, relocate the compressor to a different circuit.

Always prioritize using additional air hose over utilizing extension cords. If extension cords are necessary, they must be at least 12-gauge with a maximum length of 25 feet. The circuit fuse type should be a time-delay fuse. Note that low voltage may cause damage to the motor.

	Rick of Moving Parts
	Risk of Burns
	Risk of Falling
	Risk of Flying Objects
	Risk of Breathing
	Risk of Electrical Shock
	Risk of Explosion or Fire
	Risk of Bursting

## Rick of Moving Parts

All guards and covers must be properly installed during air compressor operation. Do not use the compressor if any guard is missing or damaged; have it repaired by authorized personnel before use. Ensure the power cord is free of kinks, bends, or damage, and handle it with care during storage.

## Risk of Burns

Certain surfaces on your air compressor can become extremely hot during and after operation, posing a risk of serious burns if touched. Allow the equipment to cool completely before performing any maintenance. Components like the compressor pump and outlet tube remain hot and should be handled with caution.

# Safety Instructions

## WARNING

### What could happen:

- Abrasive tools such as sanders and grinders, rotating tools such as drills, and impact tools such as nail gun, staplers, wrenches, hammers, and reciprocating saws can generate sparks that may ignite flammable materials.
- It is normal for the compressor motor and pressure switch to produce sparks while operating. If sparks come into contact with vapors from gasoline or other solvents, they may ignite, causing a fire or explosion.
- Exceeding the maximum pressure rating of tools or accessories could result in an explosion, causing serious injury.

### How to prevent it:

- Never operate tools near flammable substances such as gasoline or cleaning solvents.
- Work in a clean, well-ventilated area free of combustible materials.
- Never use oxygen, carbon dioxide, or other bottled gases as a power source for air tools.
- Use compressed air regulated to a maximum pressure that does not exceed the rated pressure of any attachments.
- Always verify before using the tool that the air source has been adjusted to the appropriate air pressure range.
- Never spray flammable liquids in a confined area and avoid spraying where sparks or flames are present.
- Do not smoke while spraying.

## Risk Of Falling

The air compressor must always be operated in a stable position. Never use the compressor on a rooftop or any elevated surface where it could fall or tip over. For elevated tasks, use additional air hose instead.

## Risk Of Flying Objects

**NEVER** direct compressed air or aim any nozzle or sprayer at yourself, other people, or animals. Always turn off the air compressor and fully drain the air tank before performing maintenance or disconnecting hoses or fittings. Handle nozzles and sprayers responsibly to avoid accidents.

## Risk Of Breathing or Inhalation Hazard

### WARNING

### What could happen:

- Abrasive tools such as grinders, sanders, and cut-off tools generate dust and abrasive materials that can be harmful to the lungs and respiratory system.
- Some materials, such as adhesives and tar, contain chemicals whose vapors could cause respiratory damage. Be sure to read all instructions to ensure that your respirator mask provides adequate protection.

### How to prevent it:

- Always work in a clean, dry, and well-ventilated area.
- Never directly inhale compressed air produced by a compressor, as it is not suitable for breathing purposes.
- Always read labels and follow safety instructions when spraying paints or toxic materials.

# Safety Instructions

## Risk Of Electric Shock

### **WARNING**

#### What could happen:

- Using air tools powered by an oil-less air compressor to attach electrical wiring can result in electrocution or death.
- Improper electrical connections with the oil-less air compressor can lead to fires, electrocution, or death.
- If the oil-less compressor is not provided with an insulated gripping surface, contact with a “live” wire can electrify exposed metal tool parts, leading to electrocution or death.
- Fasteners propelled by the oil-less air compressor coming in contact with hidden electrical wiring could cause electrocution or death.

#### How to prevent it:

- Never attach electrical wiring with energized tools when using the oil-less air compressor.
- Avoid body contact with grounded surfaces (e.g., pipes, radiators, ranges, refrigerators) as grounding increases the risk of electric shock.
- Thoroughly inspect the workpiece for hidden wiring before using the oil-less air compressor.
- Ensure all wiring is installed by a licensed electrician following local and national codes.
- Never use the oil-less air compressor outdoors in rain or on wet surfaces, as it could cause an electric shock.

## Risk of Explosion or Fire

### **CAUTION**

Never operate the air compressor near combustible materials, gasoline, or solvent vapors. If spraying flammable materials, position the air compressor at least 20 feet away from the spray area. Always use the air compressor in a well-ventilated outdoor area, never indoors or in confined spaces.

## Risk of Bursting

Always drain the air compressor tank daily or after each use. If the tank develops a leak, replace the air compressor immediately. Never use the air compressor after a leak is detected, nor attempt to repair or modify the tank. Additionally, never alter the factory settings that control tank pressure or any other function of the air compressor.

## Glossary

- **CFM:** Cubic Feet per Minute – A measure of airflow delivery.
- **SCFM:** Standard Cubic Feet per Minute – A standardized measure of air delivery under specific conditions.
- **PSIG:** Pounds per Square Inch Gauge – A unit of pressure measured relative to atmospheric pressure.
- **ASME:** American Society of Mechanical Engineers – An organization that sets safety and quality standards for mechanical equipment.
- **Code Certification:** Indicates compliance with safety standards set by organizations like UL, CUL, ETL, or CSA. Certified products have been evaluated by OSHA-authorized safety laboratories and meet applicable safety standards.
- **Cut-in Pressure:** The air compressor automatically starts refilling the tank when the pressure falls below the minimum prescribed level.
- **Cut-out Pressure:** The point at which the motor stops running after the tank reaches the maximum air pressure.

# Preparation & Installation

## Parts

1. **Air Intake Filter:** Provides clean air to the pump and must always be kept free of debris. Inspect daily before each use.
2. **Check Valve:** An internal component that closes when the pump is not in operation to retain air pressure inside the tank.
3. **Tank Safety Valve:** Allows excess tank pressure to escape into the atmosphere. This valve opens only when the tank pressure exceeds the maximum rated pressure.
4. **Pressure Switch:** Controls power to the motor and manages cut-in/cut-out pressure settings. It also provides automatic ON and OFF control for the compressor motor.
5. **Tank Pressure Gauge:** Displays the reserve air pressure in the tank.
6. **Tank Drain Valve:** Used to drain condensate from the air tank.
7. **Tank Relief Valve:** A pressure relief valve located on the side of the pressure switch. It automatically releases compressed air when the air compressor reaches cut-out pressure. Air escapes momentarily before the valve closes.
8. **Quick Connect:** Enables quick attachment and removal of the air hose.
9. **Regulator Pressure Gauge:** Displays the outgoing air pressure to the tool, controlled by the regulator.
10. **Regulator:** Controls the air pressure coming from the tank. Turn the knob clockwise to increase pressure and counterclockwise to decrease pressure.
11. **Outlet Tube:** Transfers compressed air from the pump head to the tank.
12. **Pressure Relief Tube:** Allows pump head pressure to escape to the atmosphere through the pressure relief valve, enabling the compressor to restart under a no-load condition.

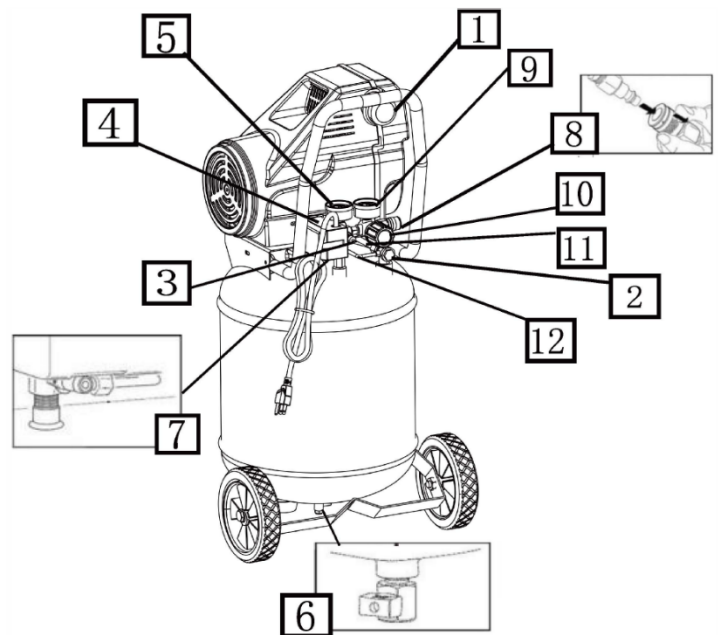

## Installation & Assembly

### **WARNING**

Before performing any maintenance, turn off the compressor, unplug it from the power source, bleed the air from the tank, and allow the unit to cool completely. Failure to follow these steps may result in personal injury from moving parts, electrical components, compressed air, or hot surfaces.

The air compressor must always be placed in a clean, dry, and well-ventilated area. Ensure there is at least 12 inches of clearance on all sides. Keep the air filter area free from debris or obstructions. Inspect the air filter daily to ensure it is clean and functioning properly.

### CAUTION

This product contains an electric motor that may produce arcs and sparks during operation. Do not use or store this product near flammable liquids or vapors. It is not designed for installation or use in commercial garages or shop environments.

## Grounding Instructions

This product must be properly grounded. Grounding reduces the risk of electric shock in the event of a short circuit by providing a safe path for electrical current. The power cord is equipped with a grounding wire and an appropriate grounding plug (see figure below). Ensure the plug is inserted into an outlet that is correctly installed and grounded in compliance with all local codes and regulations.

### WARNING

**Improper installation of the grounding plug poses a risk of electric shock. If the power cord or plug requires repair or replacement, do not connect the grounding wire to either flat blade terminal. The grounding wire is identified by insulation with a green outer surface, with or without yellow stripes. If the grounding instructions are unclear or you are uncertain whether the product is properly grounded, consult a qualified electrician or service technician. Do not modify the provided plug. If the plug does not fit the outlet, have a proper outlet installed by a qualified electrician.**

This product is designed for use on a circuit with a nominal rating of 120 volts. It comes factory-equipped with a specific electric cord and plug to ensure proper connection to the correct circuit. Always ensure the outlet matches the plug configuration. Do not use an adapter with this product. If the product needs modification for use with a different type of electrical circuit, contact qualified service personnel to perform the modification.

## Extension Cord Use

Use only a 3-wire extension cord equipped with a 3-blade grounding plug and a 3-slot receptacle compatible with the product's plug. Ensure the extension cord is in good condition and heavy enough to handle the current required by the product. The extension cord must not exceed 25 feet in length and must be #12 AWG. Using an undersized cord can lead to a drop in voltage, resulting in power loss and potential overheating.

## Breaking-In Procedures

**No break-in procedure is required for this product. It has been factory tested to ensure proper operation and performance.**

## Daily Start-Up Procedures

1. **Inspect the Compressor:** Check for any visible damage, loose connections, or signs of wear. Ensure all guards and covers are properly installed.
2. **Check the Air Filter:** Confirm the air filter is clean and free of debris. Replace if necessary.
3. **Drain the Tank:** Ensure the air tank is drained of any condensate from the previous use.
4. **Verify Power Source:** Ensure the compressor is connected to the correct power supply and that the grounding plug is securely connected to a grounded outlet.
5. **Inspect Hoses and Connections:** Check all air hoses and fittings for leaks or damage. Ensure they are securely attached.
6. **Ensure Proper Ventilation:** Confirm the compressor is placed in a clean, dry, and well-ventilated area with at least 12 inches of clearance on all sides.
7. **Set Regulator Pressure:** Adjust the regulator to the desired pressure for your tool or application.

## Operation

8. **Turn on the Compressor:** Switch on the compressor and allow it to reach the cut-out pressure before use.
9. **Test Operation:** Check the functionality of connected tools and ensure the compressor is operating smoothly before beginning work.

## Daily Shut-Down Procedures

1. **Turn Off the Compressor:** Set the Auto-On/Off lever to the Off position.
2. **Disconnect Power:** Unplug the power cord from the receptacle.
3. **Release Outlet Pressure:** Adjust the regulator to set the outlet pressure to **zero**.
4. **Detach Tools and Accessories:** Remove any connected air tools or accessories.
5. **Reduce Tank Pressure:** Pull the safety valve ring until the tank pressure gauge reads below **20 PSI**.
6. **Drain the Tank:** With the tank pressure below **20 PSI**, open the drain valve to release water condensate and air from the tank. After the tank is fully bled, close the drain valve to prevent debris buildup.

### ⚠ CAUTION

When draining the tank, always wear appropriate ear and eye protection. Perform the drainage in a suitable location, as water condensate is typically present during the process.

### ⚠ WARNING

Water left in the tank during storage can lead to tank rupture. To prevent serious injury, always drain the tank thoroughly after each use.

## Maintenance

### NOTICE

Any service procedures not outlined in the maintenance schedule must be performed by qualified service personnel.

### ⚠ CAUTION

Before performing any maintenance, turn off the air compressor, unplug it from the power source, bleed the air from the tank, and allow the unit to cool completely.

### ⚠ WARNING

To ensure efficient operation and extend the life of the air compressor, a routine maintenance schedule should be followed. The maintenance schedule provided is designed for consumers using the compressor in a typical working environment.

## Daily Shut-Down Procedures

Check the safety valve as follows:

1. **Reach Cut-Out Pressure:** Plug in the compressor and allow it to run until it reaches cut-out pressure.
2. **Release Pressure:** While wearing safety glasses and hearing protection, pull the safety valve ring to release air pressure from the tank.
3. **Observe Safety Valve Function:** The safety valve should automatically close at approximately **40-80 PSI**. If the safety valve fails to release air when the ring is pulled, or if it does not close automatically, the valve must be replaced immediately.

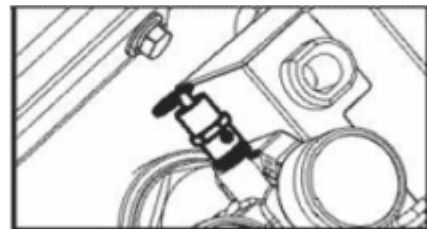

# Maintenance

## Air Filter Cleaning

Occasionally, the air filter should be removed and cleaned. Follow these steps:

1. **Charge the Tank:** Charge the tank with compressed air, then turn off the compressor and unplug it.
2. **Remove the Air Filter Cover:** Turn the air filter cover counterclockwise to remove it from the air filter compartment.
3. **Remove the Air Filter:** Take the air filter out of the air filter housing.
4. **Clean the Air Filter:** Use compressed air to blow through the air filter for 10-15 seconds to remove dust and debris.
5. **Reassemble:** Place the air filter back into the housing and secure the cover by turning it clockwise.

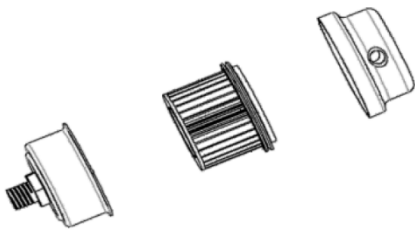

## Maintenance Schedule

Items to Check/Change	Frequency
Check Tank Safety Valve	Each Use
Overall Unit Visual Check	Daily
Check Air Intake Filter	Each Use
Drain Tank	Weekly
Check Power Cord for Damage	Each Use

## Storage Instructions

Follow these steps when storing the air compressor:

1. **Turn Off and Unplug:** Switch off the unit and unplug the power cord from the receptacle.
2. **Detach Accessories:** Remove all air hoses, accessories, and air tools from the air compressor.
3. **Complete Daily Maintenance:** Perform the daily maintenance procedures as outlined in the manual.
4. **Release Tank Pressure:** Pull the safety valve ring until the tank pressure drops to approximately 20 PSI.
5. **Drain the Tank:** Open the drain valve to release all remaining air and moisture from the tank.
6. **Close the Drain Valve:** Once the tank is completely drained, close the drain valve to prevent debris buildup.
7. **Store Properly:** Place the air compressor in a clean, dry location to protect it from dirt and moisture.

## Troubleshooting Guide

<b>Problem</b>	<b>Possible Causes</b>	<b>Probable Solutions</b>
<b>COMPRESSOR FAILS TO START</b>	Power source issue, blown fuse, or tripped circuit breaker	Check if the power cord is properly plugged in. Verify outlet functionality. Reset circuit breaker or replace fuse with a time-delay type. Avoid using extension cords.
<b>COMPRESSOR STARTS, BUT DOESN'T BUILD PRESSURE</b>	Air leaks, faulty pressure switch, or worn piston seal	Inspect hoses, fittings, and connections for air leaks using soapy water; repair any leaks. Ensure pressure relief valve and petcock are closed. If persistent, seek technician assistance.
<b>EXCESSIVE NOISE OR VIBRATION</b>	Loose parts, worn bearings, or improper surface	Ensure compressor is on a stable, level surface. Check and tighten any loose bolts, nuts, or fittings. If the noise continues, bearings may need servicing.
<b>COMPRESSOR RUNS CONTINUOUSLY WITHOUT REACHING THE NORMAL PSI</b>	Air leak, damaged tank, or faulty pressure switch	Check for air leaks with soapy water and repair as needed. Inspect a tank for damage or corrosion. If there is no leak, pressure switch may need adjustment or replacement.
<b>AIR PRESSURE DROPS QUICKLY</b>	Leak in the tank, fittings, or attached tools	Inspect all connections and tanks for leaks. Tighten or replace faulty connections and ensure tools are properly connected and functioning.
<b>MOTOR OVERHEATS</b>	Overloading, lack of ventilation, or continuous use	Allow the compressor to cool between uses. Ensure well-ventilated area, keeping unit 12 inches from walls. Avoid continuous use at maximum PSI.
<b>PRESSURE RELIEF VALVE ENGAGES FREQUENTLY</b>	Over pressurization, faulty pressure switch, or blocked valve	Inspect pressure switch for correct settings. Check relief valve for obstructions and clean if needed. If the issue persists, consult technician for switch replacement.

# Specifications

<b>Product Description</b>	10 Gallon Oil-free Air Compressor
<b>Oil Type</b>	Oil-free
<b>Configuration</b>	Vertical
<b>Tank Capacity (gallon)</b>	10
<b>SCFM @ 90PSI</b>	4
<b>SCFM @ 40PSI</b>	5
<b>Peak Power (hp)</b>	2
<b>Rated Power (hp)</b>	1.5
<b>Max Pressure (psi)</b>	150
<b>Cut-in Pressure (psi)</b>	120
<b>Cut-out Pressure (psi)</b>	150
<b>Pressure Gauges</b>	2
<b>Quick Connect Coupler</b>	1PC, Universal, NPT1/4
<b>Wheels</b>	7" 2PCS Solid
<b>Unit Size (inch)</b>	16.9"X16.5"X33.9"
<b>Unit Weight (lbs.)</b>	68.2
<b>Warranty</b>	1 Year P&L

# Exploded View

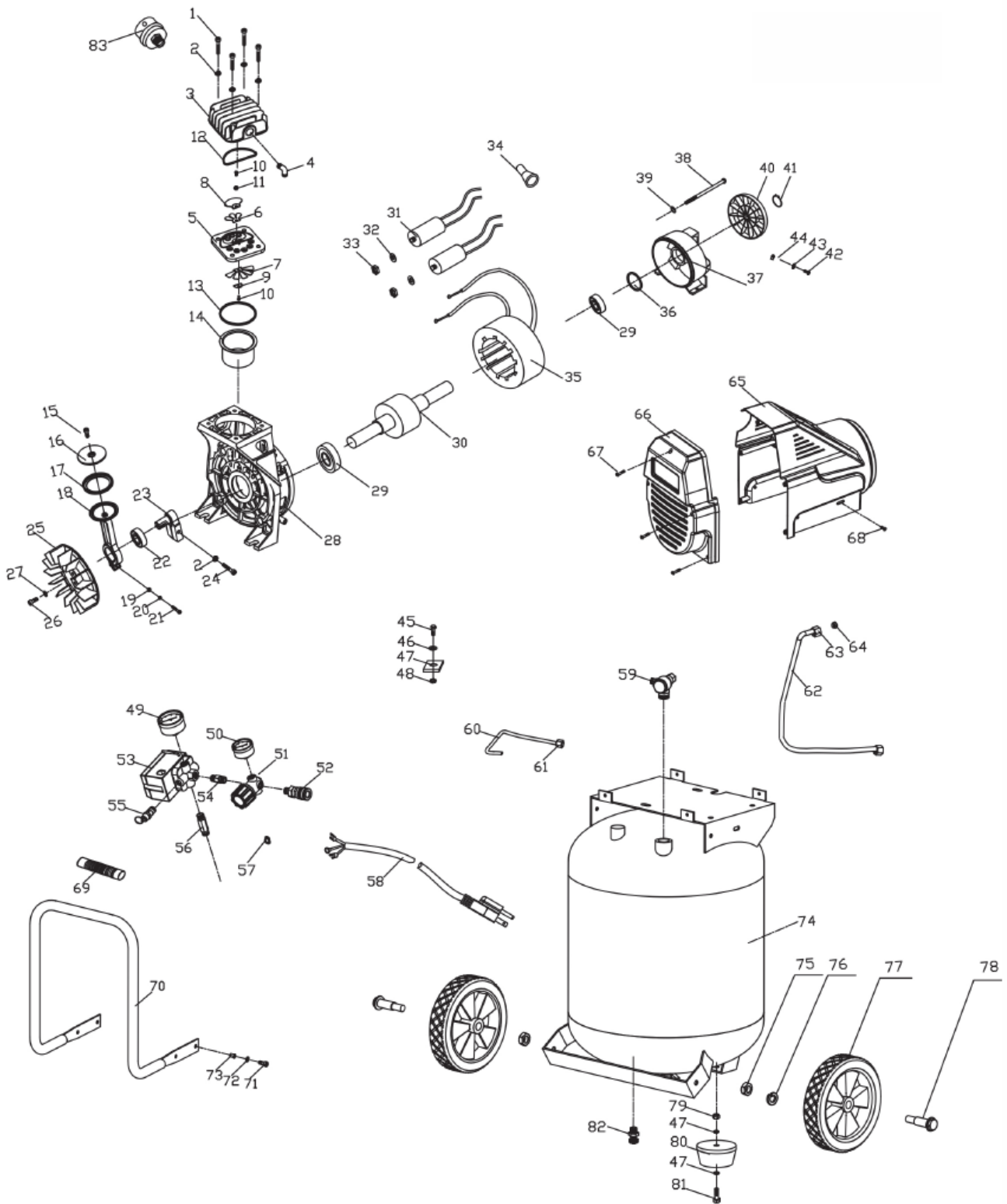

## Parts List

Num#	Part#	Description	Qty
1	45.143A	Screw M6X35 GB/T70	4
2	45.092	Lock Washer 6 GB/T93	5
3	03.254	Cylinder Head	1
4	42.002C	Elbow ZG1/2-G3/8	1
5	03.255	Valve Plate	1
6	34.020	Exhaust Reed Valve	1
7	34.021	Inlet Reed Valve	1
8	34.016	Exhaust Valve Limiter	1
9	34.015	Inlet valve Retainer	1
10	45.111	Screw	2
11	45.094	Lock Washer 6 GB/T93	1
12	36.040	O-Ring, D Shape	1
13	36.041	O-Ring, High Temperature	1
14	03.047A	Cylinder $\phi$ 63x45	1
15	45.327	Screw M6x16 GB/T70 EG	1
16	03.251	Piston Cap	1
17	29.030	Piston Ring	1
18	03.250	Connecting Rod	1
19	45.080	Hex Nut GB/T41	1
20	45.093	Lock Washer,5 GB/T93	1
21	45.133	Screw M5x25 GB/T70	1
22	31.023	Deep Groove Ball Bearing	1
23	12.035	Eccentric	1
24	45.269A	Screw M6X40 GB/T70	1
25	06.164	Nylon Fan $\phi$ 130	1
26	45.325	Screw M6X16-LH GB/T70	1
27	45.072	Washer, 6 GB/T96	1
28	03.256	Crankcase	1
29	31.022	Bearing 6203-2RS	2
30	04.244C	Rotor	1
31	27.046	Capacitor	2
32	45.066	Washer, 8mm	1
33	45.231A	Screw M8	1
34	47.1226A	Wire Connector	2
35	04.020D1	Stator	1
36	46.002	Wavy Washer	1
37	09.086A	Rear Motor Housing	1
38	45.031	Screw, Motor Assembly	4
39	45.093	Lock Washer,5mm GB/T93	4

40	06.018B	Fan	1
41	46.010	Snap Ring	1
42	45.203	Screw M4x6 GB/T823	1
43	45.058	Washer,4mm	1
44	46.066	Grounding Identification	1
45	45.151A	Bolt M8x30 GB/T70	4
46	45.064	Washer, 8mm GB/T97	8
47	36.016	Motor Isolator	4
48	45.106	Nut, M8	4
49	23.067	Pressure Gage(1/4NPT 0-270 psi)	1
50	23.066	Pressure Gage(1/8NPT 0-270 psi)	1
51	25.004A	Regulator	1
52	42.080	Quick Connect, NPT1/4	1
53	21.026	Pressure Switch(120-150PSI)	1
54	42.027	Pipe Nipple, 1/4 NPT X30mm	1
55	24.021	Safety Valve, 165psi	1
56	42.028	Pipe Nipple, 1/4 NPT X48mm	1
57	21.040	Strain Relief Bushing	1
58	22.005	Power Cord	1
59	38.021C	Check Valve	1
60	44.002B	Pressure Relief Tube	1
61	43.221	Flare Nut, 6mm	1
62	43.224	Outlet Tube	1
63	44.017	Compression Nut	2
64	46.073	Compression Washer,10mm	2
65	06.111	Rear Shroud	1
66	06.110	Front Shroud	1
67	45.296	Screw, Shroud	5
68	45.085C	Screw, M5x12mm GB/T5787	4
69	37.008D	Grip $\phi 22 \times 115$	1
70	18.021	Handle	1
71	45.140	Screw M6*20 GB/T70	4
72	45.067	Flat Washer, 6mm	4
73	45.086	Rivet Nut, M6	4
74	08.292	Tank	1
75	45.076	Nut M10	2
76	45.090	Lock Washer, 10mm GB/T93	2
77	15.011A	Wheel	2
78	46.039B	Axle M10	2
79	45.231	Nut M8	1
80	15.014	Isolator	1
81	45.228	Screw, M8	1

82	39.019	Drain Valve	1
83	41.042	Air Filter	1



**For product questions or to order replacement parts, please  
call 1-866-591-8921 or email [support@pulsar-products.com](mailto:support@pulsar-products.com).**

Goodyear (and Winged Foot Design) are trademarks of or licensed to The Goodyear Tire & Rubber Company or Goodyear Canada Inc. used under license by Pulsar Products Inc, 8676 Rochester Ave, Rancho Cucamonga, CA 91730. © 2024 The Goodyear Tire & Rubber Company.