

Quick Start

p-collar 910

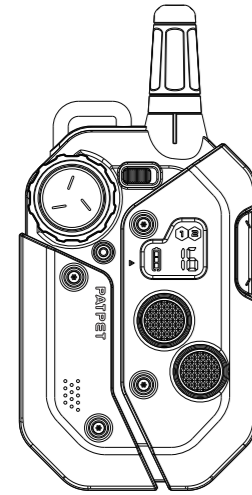

Thanks for purchasing!

The dog training collar is designed to let dogs live safely, happily and get along with people more harmoniously.

⚠ WARNING Do not use with aggressive dogs.

Aggressive dogs can cause severe injury and even death to their owner and others. If you are unsure whether this product is appropriate for your dog, please consult your veterinarian or certified trainer.

⚠ CAUTION Safety during on-leash training.

It is vitally important that you and your dog remain safe while learning during on-leash training. Your dog should be on a strong leash, long enough for him to attempt to chase an object, but short enough for him not to reach a road or other unsafe area. You must also be physically strong enough to restrain your dog when he tries to chase.

⚠ CAUTION Risk of skin damage.

Please read and follow the instructions in this manual. Proper fit of the collar is important. A collar worn for too long or made too tight on the pet's neck may cause skin damage ranging from redness to pressure ulcers. This condition is commonly known as bed sores.

- Avoid leaving the collar on the dog for more than 12 hours per day.
- When possible reposition the collar on the pet's neck every 1 to 2 hours.
- Never connect a lead to the electronic collar; it will cause excessive pressure on the contacts.
- If a rash or sore is found, discontinue use of the collar until the skin has healed.
- If the condition persists beyond 48 hours, see your veterinarian.
- This product is not a toy, please keep away from children.
- This product is only for use with healthy dogs.

Please read the quick start before beginning.

0.3.0.02.910X00-PT-00

Overview

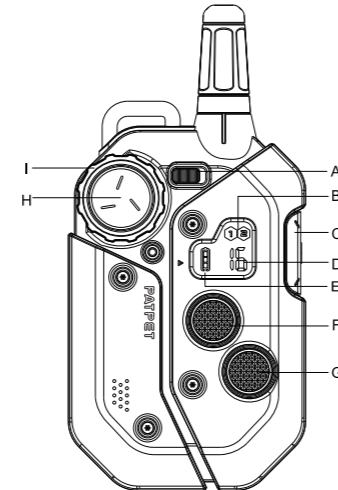

Remote

- A. Dog 2 /Dog 1
- B. Dog 2 /Dog 1 display
- C. Vibration button
- D. Shock level display
- E. Battery display
- F. Tone button
- G. Shock button
- H. ON/OFF
- I. Shock level knob
(Increase shock level / Decrease shock level)

Receiver Collar

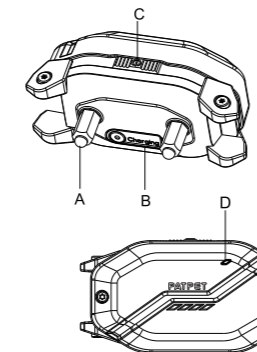

- A. Contact points
- B. Charging port (with cover)
- C. On/Off button
- D. LED Indicator
- E. Contact spring sheet



Setting Up the Product

Before you can use the Dog Training Collar, you must set up the product as below steps:

1. Charging the Remote and the Receiver Collar.
2. Prepare the Remote and turn it on.
3. Prepare the Receiver Collar and turn it on.
4. Function test, test function of buttons before wearing it on dog.
5. How to use the Test Lamp, test shock function or use as a screw driver.
6. Pair the Remote and the Receiver Collar, pair them when the product lose its code or pair for a second collar.

Charging the Remote and the Receiver Collar

1. Plug in and fully charge the Remote and the Receiver collar. For the initial charge, be sure to charge it for 4 hours. Subsequent charges only take 2-3 hours.
2. When full charged, the red LED on the Receiver Collar will become green. The Battery Display of the Remote will stop cycling and appear full.
3. Please replace the rubber cover when the Receiver Collar is full charged.

Tips:

1. Excessive charging will shorten battery life. Only charge them when batteries are low.
2. When you're not using the collar, please turn it off to increase the battery life.

NOTE:

Please use the Output: DC 5V 0.5-2A charger to charge the product. Don't use a charger that does not meet the specifications to charge the product.

Prepare the Remote

Turn ON/OFF the Remote

1. Press and Hold the ON/OFF button to turn the remote ON.
2. Screen will be lighted, and show the information of current channel, battery power and levels. If not, please charge the remote.
3. Press and Hold the ON/OFF button to turn the remote OFF.

Prepare the Receiver

Please use our distribution test tool to install the contact points.

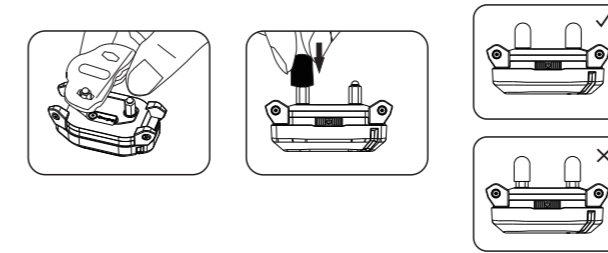

You can also choose to use contact spring sheet, which make the contact more effective and more comfortable.

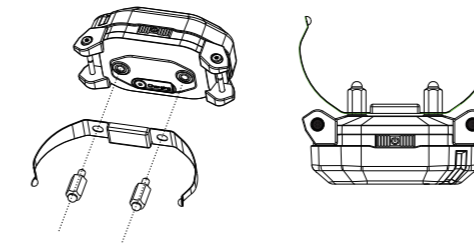

Turn on the Receiver Collar

- Press and Hold the On/Off Button the Green LED light comes on.
- In normal mode, the Green LED will flash every 4 seconds, indicating the Receiver Collar is on and ready to receive a signal from the Remote.

Turn off the Receiver Collar

- Press and Hold the On/Off Button until the Red LED light shuts off (This takes approximately 3 seconds).
- Release the On/Off Button.

NOTE:

To extend the life of the batteries, please turn the Receiver Collar off when it is not in use.

Function Test

We recommend you experience firsthand how the different levels feel on yourself and always begin at the lowest level, and increase the levels up to your personal comfort levels.

1. Place one finger over both Contact Points of the training collar.
2. Hold your remote approximately 2 ft. from the training collar. Press the Vibration Button continuously for 1 to 2 seconds. You should feel continuous vibration.
3. Rotate the shock level knob to decrease levels. Starting at level 1, press the Shock Button.
4. Increase the level until the sensation begins to feel uncomfortable.

NOTE:

1. Continuous stimulation will transmit for no more the 10 continuous seconds. To reactivate, release and press the button.
2. It is not recommended to press and hold the Vibration/Shock Button too long to avoid physical or psychological hurt to the dog.

How to Use the Test Lamp

Shock Function Test

1. Turn on the Receiver Collar.
2. Hold the Test Lamp contacts against the Contact Points.
3. Press and Hold the Shock Button and the Test Lamp will be lighted. It will be lighter accordingly with the Shock Level increasing.

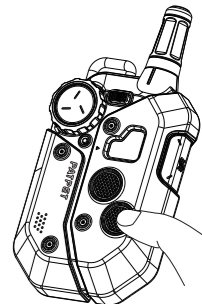
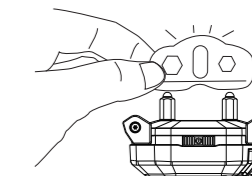

3

4

5

6

7

Pair the Remote and the Receiver Collar

1. Keep the remote in the status of dog 1.
2. With the Receiver Collar turned off, Press and Hold the ON/OFF button on the Receiver Collar for 4-5 seconds.
3. The Red & Green LED will blink for about 10 seconds indicating that it is ready for pairing.
4. Press and Hold Tone Button and Vibration Button at the same time for 2-3 seconds, the Green Led on the Receiver Collar will blink for 5 times indicating successful pairing.

Too loose:

The Receiver Collar will move around the dog's neck, the Contact Points may hurt the dog's skin.

Too tight:

It may cause dog's to breathe hard.

Caution:

1. Do not shave the pet's neck as this may increase the risk of skin irritation.
2. The collar should not be worn for more than 12 hours per day. Or it may cause skin irritation.

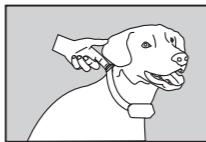

Find the Best Shock Level for Your Pet

The unit comes with Up and Down buttons to control the Shock Level, with Level 1 being the lowest level and Level 16 being the highest. The level of Shock best suited for your dog depends on your dog's temperament and threshold for Shock. Always start at the lowest level and work your way up. The appropriate level can be found when the dog responds to the Shock with a mild reaction, such as a flick of the ear, a lick of the lips, a tensing of the neck muscles etc. The Shock Level may vary depending on the training situation. When highly distracted, dog's will require a higher level of Shock.

Device Information

Product Specification

Battery Type	Rechargeable, lithium polymer battery
Battery Life(typical use)	Remote: 27 days Receiver: 11 days
Remote Waterproof Rating	IEC 60529 IPX7, waterproof
Receiver Waterproof Rating	IEC 60529 IPX7, waterproof
Operating temperature range	From 0-40°C(from 32-104°F)
Wireless Power	20dBm(100mW)
Wireless Range	900m(2950 feet)

The unit need to be charged under any of below situations

1. The indicator light on the Receiver Collar is emitting a red color every 4 seconds or flashes rapidly.
2. The 3 bar indicator on the Remote Screen shows just 1 bar.
3. The indicator light on the Remote or Receiver Collar will not come on.
4. The indicator light on the Remote or Receiver Collar comes on momentarily when any of the Mode Buttons is pressed.

Others

Frequently Asked Questions

Is the Vibration/Shock safe for my pet?	While the Vibration/Shock is unpleasant, it is harmless to your pet. Electronic training devices require interaction and training from the owner to achieve desired results.
How old does my pet have to be before using the Remote Training Collar?	Your pet should be able to recognize basic obedience commands such as "Sit" or "Stay". Pets should be at least 6 months old before using the Training Collar.
Once my pet is trained and has been obeying my commands, will he have to continue to wear the Receiver Collar?	Probably not. You may need to reinforce training with the Receiver Collar from time to time.
Is the Receiver Collar waterproof?	Yes.
Will I get exactly 2950 feet of range with the Remote Training Collar?	The range of the Remote Training will vary according to terrain, weather, vegetation, as well as transmission from other radio devices. Refer to "To maximize the distance" for tips on maximizing your range.

How long can I continuously deliver Vibration/Shock to my pet?	The maximum amount of time you can press the Vibration/Shock Button and deliver Vibration/Shock to your pet continuously is 10 seconds. After this, there's a time-out an Vibration/Shock cannot be delivered for 5 seconds. After the 5 second time-out period, Button can be pressed and Vibration/Shock can be delivered again.
---	--

Troubleshooting Guide

My pet does not respond when I press a button.	<ul style="list-style-type: none">• Make sure the Receiver Collar has been turned on.• If your range has reduced from the first time you used the Remote Training Collar, the battery(s) may be low in either the Remote or Receiver Collar.• Terrain, weather, vegetation, transmission from other radio devices and many other factors can impact the amount of range you have with the unit.• Test the Receiver Collar. Refer to "How to use the Test Lamp" for details.• Increase the Shock Level. Refer to "Find the Best Shock Level for Your Pet" for more information.• Make sure the Receiver Collar's Contact Points are placed snugly against your pet's skin. Refer to "Collar Fitting" for more information.
The Receiver Collar will not turn on.	<ul style="list-style-type: none">• Make sure the Receiver Collar has been charged. For the initial charge, be sure to charge it for 4 hours. Subsequent charges only take 2-3 hours.
The Receiver Collar is not responding to the Remote.	<ul style="list-style-type: none">• Make sure the Receiver Collar is on.• If the Indicator Light does not come on when any button is pressed on the remote, ensure that the batteries are charged properly.• If the first two solutions did not resolve your problem, Refer to "Pair the Remote and the Receiver Collar".

Warranty and repair information

1-Year Limited Lifetime Warranty

The original purchaser for this unit is provided with 1-YEAR WARRANTY. The warranty begins from the date of purchase. For the first year, coverage is for both Parts and Labor on warranty repair services. Accessories such as straps and batteries are covered for the first year only. After the first year, the Limited Lifetime Warranty covers Parts only and does not cover Labor Fees and Accessories. All shipping fees incurred, the cost of Accessories after the first year, and Labor fees associated with out of warranty repair work, are the customer's responsibility. Labor fees will be variable depending on the extent of the work required. The Limited Lifetime Warranty expires 5 years after a model is discontinued from production.

To Qualify for the Warranty

All products must provided a proof of purchase is required to initiate repair work under warranty. We strongly recommend keeping the original receipt. If a proof of purchase is not available at the time of service, we will estimate the age of unit by the serial number. Serial number estimates can differ from the actual purchase date. A serial number estimate is the only method of determining an approximate date of purchase without a proof of purchase.

Not Covered Under Warranty

We DO NOT offer warranty for products that have been bought secondhand or as a resold product. We DO NOT replace defective units or provide refunds for products purchased from us after 30 days from the date of purchase. Issues of replacement and refunds on units purchased less than 30 days from an authorized dealer must be addressed to the dealer directly. If the products purchased from an authorized dealer are after 30 days from the date of purchase, please send the units to us for service and repair. We DO NOT cover the cost of repairs and replacements due to misuse by the owner or dog, improper maintenance, and/or lost units. Any water damage on the Water Resistant remote and the Water Resistant Receiver of our product

series will not be covered. All replacement costs for either the remote or receiver will be the owner's responsibility. The warranty is void if the unit has been altered or an unauthorized person has damaged the unit while attempting repair work. We reserve the right to retain and discard any parts or accessories that have been found damaged upon replacement and repair.

Procedure for Repair Work

If the unit is malfunctioning, please refer to the "Troubleshooting Guide" in the quick start before sending it back for Service. The cost of shipping products under warranty back is the customer's responsibility. We are not responsible for units damaged or lost in transition. We are not responsible for loss of training time or inconvenience while the unit is in for repair work. We do not provide loaner units or any form of compensation during the repair period. A copy of the sales receipt showing the purchase date may be required before warranty work is initiated. Please include a brief explanation outlining the problem and include your name, address, city/state/zip code, daytime phone number, evening phone number, and email address.

Compliance

FCC - USA

This device complies with part 15 of the FCC Rules. Operation is subject to the following two conditions:
(1) This device may not cause harmful interference.
(2) this device must accept any interference received, including interference that may cause undesired operation.

CAUTION: Modification or changes to this equipment not expressly approved by manufacturer may void the user's authority to operate the equipment.

NOTE: This equipment has been tested and found to comply with the limits for a Class B digital device, pursuant to part 15 of the FCC Rules. These limits are designed to provide reasonable protection against harmful interference in a residential installation. This equipment generates uses and can radiate radio frequency energy and, if not installed and used in accordance with the instructions, may cause

harmful interference to radio communications. However, there is no guarantee that interference will not occur in a particular installation. If this equipment does cause harmful interference to radio or television reception, which can be determined by turning the equipment off and on, the user is encouraged to try to correct the interference by one or more of the following measures:
-Reorient or relocate the receiving antenna.
-Increase the separation between the equipment and receiver.
-Connect the equipment into an outlet on a circuit different from that to which the receiver is connected.
-Consult the dealer or an experienced radio/TV technician for help.

PATPET

The R&D of Dog Remote Training Collar

<https://patpet.us/>

service@patpet.com

@PATPET

Shenzhen Patpet Technology Co., Ltd
Add: No.1 Qinhuai Road, Gushu Community,
Xixiang Street, Baoan District, Shenzhen, China

