

ECSS

Electric Chain Saw Chain Sharpener Assembly & Operating Instructions



READ ALL INSTRUCTIONS AND WARNINGS BEFORE USING THIS PRODUCT.

SAVE THESE INSTRUCTIONS FOR FUTURE REFERENCE.

This manual provides important information on proper operation and maintenance. Every effort has been made to ensure the accuracy of this manual. We reserve the right to change this product at any time without prior notice.

STOP! DO NOT RETURN THIS PRODUCT TO THE RETAILER.

Questions? Problems? CONTACT CUSTOMER SERVICE.

If you experience a problem or need parts for this product, visit our website <http://www.buffalotools.com> or call our customer help line at 1-888-287-6981, Monday-Friday, 8 AM - 4 PM Central Time. A copy of the sales receipt is required.

TABLE OF CONTENTS

RECOGNIZE SAFETY SYMBOLS, WORDS AND LABELS	2
SERVICE	5
SPECIFIC SAFETY RULES AND/OR SYMBOLS	6
PACKAGE CONTENTS	6
COMPONENTS	7
ASSEMBLY	7
OPERATION	9
MAINTENANCE	10
PARTS DIAGRAM	11
PARTS LIST	11

RECOGNIZE SAFETY SYMBOLS, WORDS AND LABELS

What You Need to Know About Safety Instructions

Warning and Important Safety Instructions appearing in this manual are not meant to cover all possible conditions and situations that may occur. Common sense, caution and care must be exercised when assembling or using this product.

Always contact your dealer, distributor, service agent or manufacturer about problems or conditions you do not understand.



This is a safety alert symbol. It is used to alert you to potential personal injury hazards. Obey all safety messages that follow this symbol to avoid possible injury or death.



This is a safety alert symbol. It is used to alert you to potential personal injury hazards. Obey all safety messages that follow this symbol to avoid possible injury or death.

GENERAL PRODUCT SPECIFICATIONS



FEATURES:

- 120V / 60 Hz
- 4200 RPM Grinding Speed (2016 4600 RPM)
- 4 1/4" x 1/8"
- 7/8 Inch Arbor
- Motor 120V, 60Hz, 85 Watts
- RPM 4200
- Gauge 0.080" to 0.050"
- Will not work with .043" Gauge
- Table Vise Angles 35 Degrees Right to Left
- Arbor Diameter 7/8" / Saw Chain Pitch is 3/8"
- Wheel Dimensions 4-1/4"Dia. x 1/8" Thick
- Overall Dimensions 9"W x 10"L x 12-1/8"H

SPECIFICATIONS

- | | |
|-----------------|--------------|
| • Rated Voltage | 120V / 60 Hz |
| • Watts | 50 Watts |

KEEP THIS MANUAL, SALES RECEIPT & APPLICABLE WARRANTY FOR FUTURE REFERENCE. READ ALL INSTRUCTIONS AND WARNINGS BEFORE USING THIS PRODUCT. When unpacking, check to make sure all parts listed are included. If any parts are missing or broken, please call Customer Service at 1-888-287-6981.

FOR CONSUMER USE ONLY – NOT FOR PROFESSIONAL USE

IMPORTANT SAFETY RULES

COMMON SENSE AND CAUTION ARE FACTORS WHICH CANNOT BE BUILT INTO ANY PRODUCT. THESE FACTORS MUST BE SUPPLIED BY THE OPERATOR.

WARNING

Keep your work area clean and well lit. Cluttered work benches and dark work areas may cause accidents or injury.

Do not operate tools in explosive areas, such as in the presence of flammable liquids, gases or dust. Tools can create sparks which may ignite the dust or fumes.

Keep bystanders, children and visitors away while operating a power tool. Distractions can cause you to lose control.

WARNING

Double insulated tools are equipped with a polarized plug (one blade is wider than the other.) This plug will fit in a polarized outlet only one way. If the plug does not fit fully in the outlet, reverse the plug. If it still does not fit, contact a qualified electrician to install a polarized outlet. Do not change the plug in any way. Double insulation eliminates the need for the three wire grounded power cord and grounded power supply system.

Avoid body contact with grounded surfaces such as pipes, radiators, ranges and refrigerators. There is an increased risk of electric shock if your body is grounded.

Do not abuse the cord. Never use the cord to carry the tool or pull the plug from an outlet. Keep the cord away from heat, oil, sharp edges, or moving parts. Replace damaged cords immediately. Damaged cords increase the risk of electric shock.

When operating the tool outside, use an outdoor extension cord marked “WA” or “W.” These cords are rated for outdoor use and reduce the risk of electric shock. Make sure the extension cord being used is in good condition. If there are any cuts or nicks (no matter how deep) in the insulation, DO NOT use that cord. Also, make sure the extension cord is heavy enough to carry the current needed. DO NOT use small “around-the-house” lamp extension cords. These cords can easily overheat and/or catch fire when used with power tools.

CAUTION

Do not force tool. Use the correct tool for your application. The correct tool will do the job better and safer at the rate for which it is designed.

Do not use the tool if the power switch does not turn it “ON” or “OFF”. Any tool that cannot be controlled with the switch is dangerous and must be repaired.

Disconnect the power cord plug from the power source before making any adjustments, changing accessories or storing the tool. Such preventive safety measures reduce the risk of starting the tool accidentally.

Store idle tools out of reach of children and other untrained persons. Tools are dangerous in the hands of untrained users.

DANGER

People with pacemakers or other electronic devices should consult with a physician before operating this product. Interruption or failure of the pacemaker could occur when electrical equipment is operated within close proximity of electrical devices.

⚠ WARNING

Wash hands after handling the power cord. Touching the power cord could expose you to lead, which is known in the State of California to cause cancer, birth defects and other reproductive harm.

⚠ WARNING

Use common sense while operating this power tool.

Do not use this tool if you are:

- Feeling tired or are under the influence of alcohol or drugs.
- Wearing loose clothing or jewelry. Keep long hair pulled back and away from moving parts.
- Overreaching or have improper footing. Handling the tool in this way could cause serious injury.

When using this power tool always:

- Wear the proper safety equipment, such as safety goggles, dust masks, non-skid shoes, etc.
- Check to be sure all adjusting keys or wrenches have been removed before starting the power tool.
- Check to be sure the power switch is in the “OFF” position before plugging the power tool into an electrical outlet.

⚠ CAUTION

Follow these steps to maintain safe working conditions and good working condition of power tools.

Improper care can result in electric shock or serious injury.

- Secure and support the work piece using clamps. **Do not use your hands to hold the piece in place.**
- **Use the correct tool for the job.** Using the correct tool is safer and faster.
- **Make sure the power switch is in good working order.** If the power switch no longer turns the tool “ON” or “OFF”, discontinue use, and have the tool replaced or repaired.
- **Remove the power cord from the power source before storage, changing accessories, or moving the tool.**
- **Keep out of reach of children**, or any untrained person. Store tools in a safe and dry place.
- **Keep tools clean, and cutting tools sharp.** Maintaining tools with proper care will increase the life of the power tool, and reduce the risk of injury.
- **Check to be sure all moving parts are free from binding and are properly aligned.**
- Use only accessories that are recommended by the manufacturer for your tool model.

⚠ WARNING

Safety glasses and ear protection must be worn during operation.

⚠ WARNING

This product contains chemicals known to the State of California to cause cancer and birth defects or other reproductive harm.

SERVICE

Tool service must be performed only by qualified repair personnel. Service or maintenance by unqualified personnel could result in a risk of injury.

When servicing a tool, use only identical replacement parts and follow instructions in the manual. Use of unauthorized parts or failure to follow Maintenance Instructions may create a risk of shock or injury.

SAVE THESE INSTRUCTIONS FOR FUTURE REFERENCE.

This manual contains important information regarding safety, operation, maintenance and storage of this product. Before use, read carefully and understand all warnings, cautions, instructions and labels. Failure to do so could result in serious personal injury, property damage or even death.

IMPORTANT SAFETY INSTRUCTIONS

⚠ WARNING





Before using this tool, you need to become familiar with its operation. If you are unsure about the operation of the tool, or have any questions about its proper use, call the Customer Service Department at 1-888-287-6981. Follow these instructions for safe handling of the tool:

- **Be sure your work area is clean and secure before turning the power switch into the “ON” position.** Be sure the area is free from all foreign material, nails, staples, or any other material.
- **Turn the tool “OFF” and unplug from the power source before making any changes or adjustments to the tool.**
- **Do not use solvents containing carbon tetrachloride, ammonia or acetone to clean the tool.** Never use gasoline, paint thinner, or other caustic chemicals that can damage the plastic parts.
- **Always use the appropriate safety gear when operating this tool.** Including but not limited to, goggles, dust mask or respirator. Always work in a well-ventilated area to reduce your exposure to harmful chemicals and dust particles.
- **Keep hands away from the cutting area.**

SPECIFIC SAFETY RULES AND/OR SYMBOLS

SYMBOLS

The following symbols may be used on your tool. Be familiar with and learn the symbols to operate the tool safely.

Symbol	Name	Description
V	Volts	Voltage (Potential)
A	Amperes	Current
Hz	Hertz	Frequency (Cycles per Second)
W	Watt	Power
Kg	Kilograms	Weight
	Alternating Current	Type of Current
	Direct Current	Type of Current
	Alternating or Direct Current	Type of Current
	Earthing Terminal	Grounding Terminal
	Class II Construction	Denotes Double Insulation
min	Minutes	Time
s	Seconds	Time
φ	Diameter	Size of Drill Bits, Grinding Wheels, etc.
n_0	No Load Speed	No-load Rotational Speed
.../min	Revolutions per Minute	Revolutions, Surface Speed, Strokes, etc. per Minute
1,2,3...	Ring Selector Settings	Speed, Torque or Position Settings

PACKAGE CONTENTS

Grinding Wheel
Chain Saw Chain Sharpener

⚠ WARNING

This machine is designed to sharpen chain saw chains. Do not attempt to sharpen any other tools and do not attempt to grind any other objects.

COMPONENTS

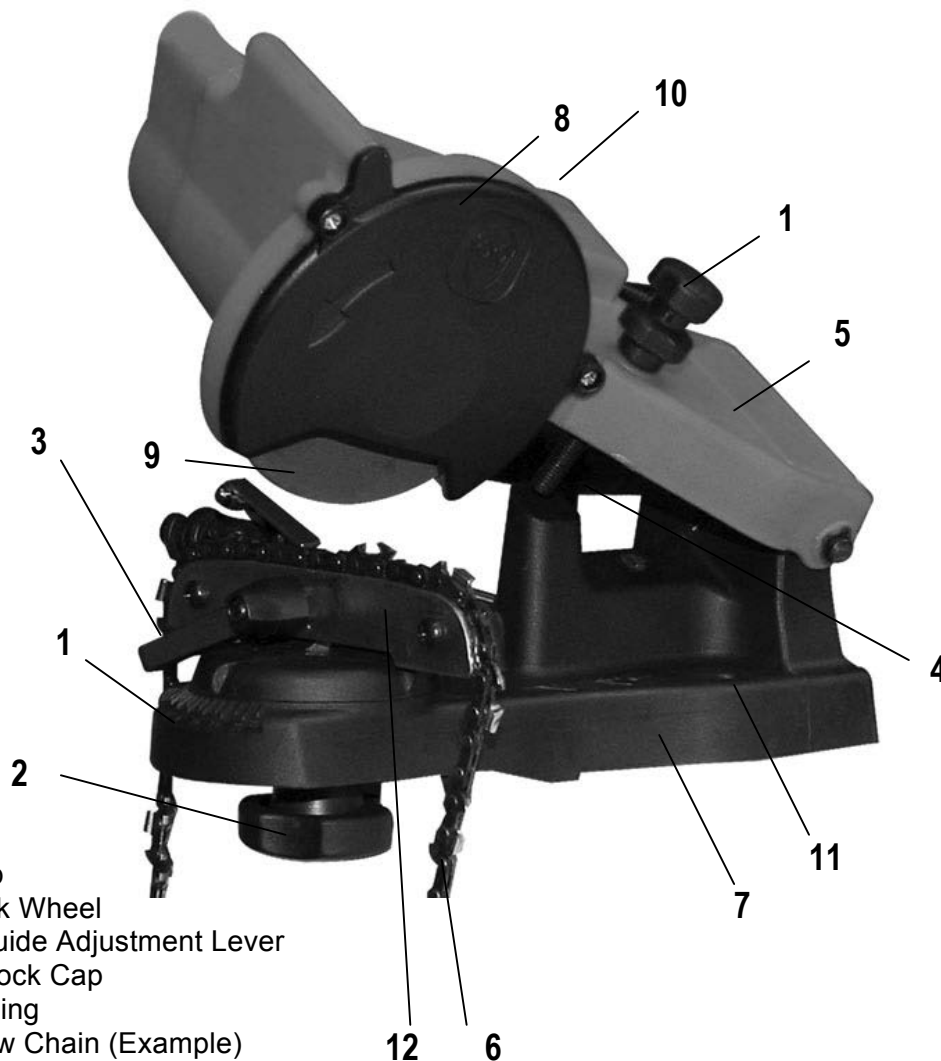

- 1) Lock Stop
- 2) Base Lock Wheel
- 3) Sliding Guide Adjustment Lever
- 4) Grinder Lock Cap
- 5) Top Housing
- 6) Chain Saw Chain (Example)
- 7) Base
- 8) Grinding Wheel Cover
- 9) Grinding Wheel
- 10) Power On / Off (not shown)
- 11) Bolt Hole For Mounting
- 12) Sliding Guide

ASSEMBLY

⚠ WARNING

Always use the proper grinding wheels. Grinding wheels that do not properly fit will cause loss of control.

⚠ WARNING

Before installing or replacing the grinding wheels, make sure the power cord is unplugged. Failure to do so could result in serious injury or electric shock.

NOTE

Unpack product from package and review contents. Keep all packaging until product has been reviewed.

1. Do not use a grinding wheel if it is chipped, cracked or worn. You can check if the wheel has cracks not visible to the human eye by hanging it up by the central hole and tapping it with a non-metal object (ie: screwdriver handle). If it is in good condition it will produce a metallic sound. A dull sound indicates a crack or break.
2. Only use grinding wheels that fit the arbor (7/8"). Do not try to change or modify the mounting hole on a grinding wheel to make it fit.
3. Do not over-tighten the Grinder Lock Cap. Hand-tighten only. Over-tightening may cause the wheel to break or disintegrate.
4. Never use the chain saw sharpener without the Grinding Wheel Cover in place.
5. Always test the Grinding Wheel by running it for a minute prior to contact with a chain.
6. Keep away from the wheel when it is turning and make sure no one is standing close, in the line of the wheel rotation trajectory.
7. If the grinding wheel vibrates, turn off the machine and check that it is mounted securely, and that it is not damaged.
8. Never try to stop the grinding wheel with your hands, even if you are wearing safety gloves. The wheel will cut through gloves and your hand causing serious injury.
9. Never operate tool without the Grinding Wheel cover in place.
10. Replacement grinding wheel listed speed must meet or exceed RPM rating of the tool.

When installing the sharpener on a workbench, make sure that the lock wheel is accessible.

Bolt (bolts not included) the unit directly to the workbench through the two 1/4" holes on the base. The workbench must have a solid surface capable of supporting the weight of this sharpener, the work-piece and assorted tools.

Mounting a Grinding Wheel

1. Raise the Top Housing and lock it in the up position by tightening the Lock Stop.
2. Remove the two screws holding the Grinding Wheel Cover. Set the cover aside.
3. Unscrew the Grinder Lock Cap that holds the Grinding Wheel in place.
4. Install the new wheel on the Grinding Wheel Base making sure it fits properly.
5. Replace the Grinder lock Cap.
6. Replace the Grinding Wheel Cover.
7. Release the Lock Stop and lower the Top Housing. Never operate tool without the Grinding Wheel Cover in place

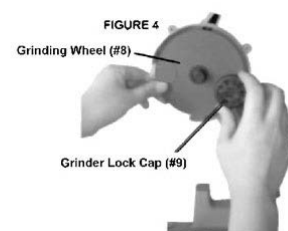
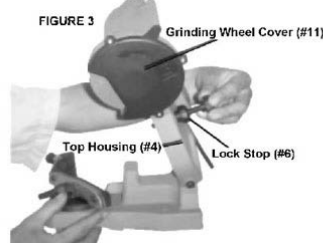
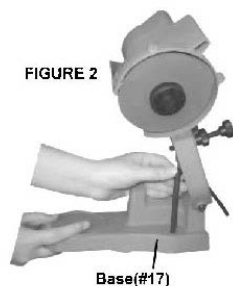
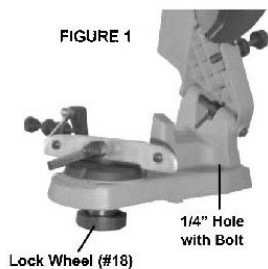

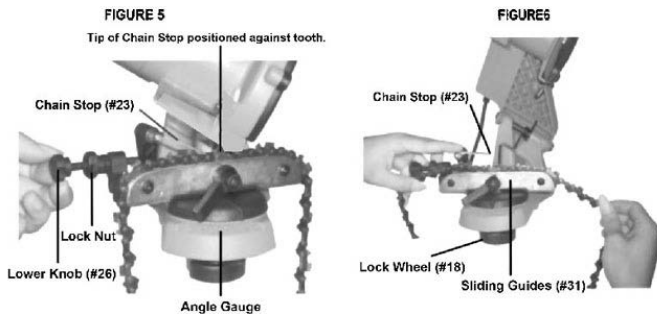

OPERATION

CAUTION

Wear safety eyewear and dust filters or respirators while using this tool.

WARNING

Keep hands and fingers away from the rotating Grinding Wheel while it is in operation. Your fingers can get stuck inside the rotating wheel and cause serious injury to the user.

1. Clean the chain before sharpening it. Wash it with a non-flammable solvent. Don't use Gasoline to dry the chain.
2. Lift up the Chain Stop and secure the chain in the Sliding Guides.
3. Lower the Chain Stop so that it is positioned on the tooth (blade) you want to start with.
4. Loosen the Lock Wheel to allow entire housing to turn. Rotate the housing to match the degree of angle you need on the Angle Gauge. Chains come in various sizes with varying degrees of sharpening angles. Check with your chain manufacturers manual to determine what degree you need to sharpen at. Once the degree is set, tighten the Lock Wheel.
5. Lower the Top Housing so that the Grinding Wheel shims the chain tooth.
6. Hold it at that position while you tighten the Lock Stop so that the Wheel will only go down to that point
7. Depending on the amount of material you wish to remove, tighten or loosen the lower Knob and set the Lock Nut. The Lower Knob has a Lock Nut, which will determine how much material is removed. Once you set the Lock Nut, fully tighten the Lower Knob.
8. Lock the chain in the Sliding Guides by turning the Handle.

The Sliding Guide Adjustment Lever should be situated so that you can easily release and tighten it. You will need to release it each time you move to the next link, and tighten it to sharpen each link.

9. If the chain has been repeatedly sharpened, the chain depth limiting gauges may need to be taken down with a flat file (not included). File down each gauge so that they are at a lower level than cutting teeth.

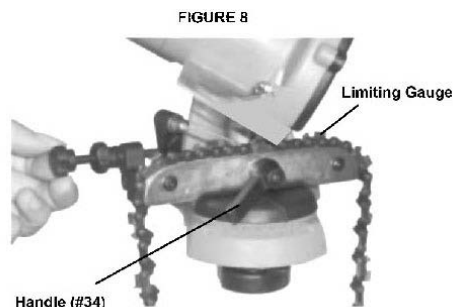
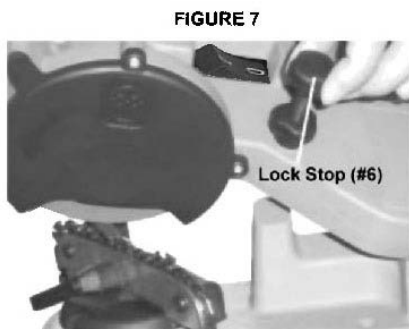
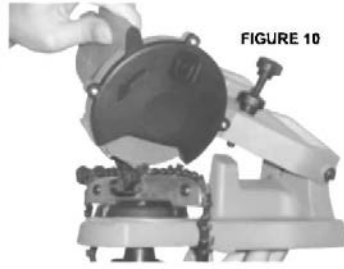

FIGURE 9



FIGURE 10



Sharpening

1. Put on your protective gear and make sure the immediate area is clear of bystanders.
2. Plug in the Power Cord and press the green button on the Switch Plate to turn on the machine.
3. Slowly lower the grinding wheel. If you notice slight errors in your settings, turn off the unit and unplug it before you make your adjustments. Note: A good grind occurs when the contact between the wheel and the teeth are gradual and smooth. Do not stop too long on each tooth.
4. After sharpening one tooth, turn off the machine. Lift the Top housing, release the Handle and move the chain so that the next link is positioned in the Chain Stop. Tighten the Handle. Turn the machine back on and continue sharpening the next tooth. Repeat this process until you have sharpened all of the links set up for this angle.
5. After you finished sharpening all of the teeth on the chain, turn off the machine by pushing the red button on the Switch Plate and unplug the unit.
6. Loosen the Lock Wheel and reset the angle so that the first tooth that hasn't been sharpened is positioned against the Chain Stop and locked in.
7. As you did with the first half of the chain, be sure to lower the Top Housing so that the Grinding Wheel skims the chain tooth, and lock it in place. Double check everything before you plug in the machine and turn it on.

MAINTENANCE

⚠ WARNING

Disconnect the power supply before cleaning. Wear safety eyewear before cleaning. Used compressed dry air to blow off dust and debris. Use a soft bristle brush if compressed air is not available.

CAUTION

Some chemicals can damage the product. Do not use harsh chemicals such as gasoline, carbon tetrachloride, paint thinner, etc.

CAUTION

A qualified repair technician must perform any tool service or repair. Service or maintenance performed by unqualified personnel could result in injury. Use only identical replacement parts. Use of unauthorized parts or failure to follow maintenance instructions may create a risk of electric shock or injury.

Check the grinding wheel before each use to make sure it isn't damaged. Do not use a grinding wheel if it is chipped, cracked, or worn. You can check if the wheel has cracks not visible to the human eye by hanging it up by the central hole and tapping it with a non metal object (ie; screwdriver handle). If it is in good condition it will produce a metallic sound. A dull sound indicates a crack or break.

Replace the grinding wheel when it grinds down to a diameter of 3 inches.

PARTS DIAGRAM

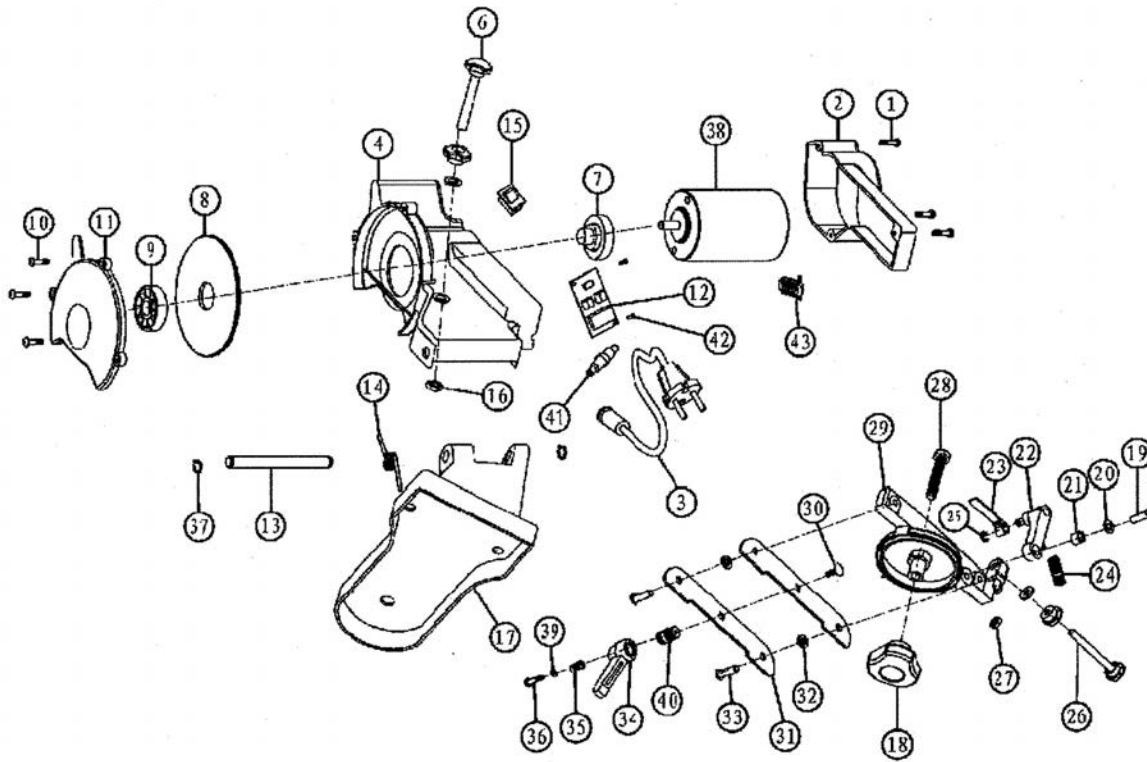

PARTS LIST

Parts No.	Description	Qty.	Parts No.	Description	Qty
1	Screw	3	23*	Chain Stop	1
2	Motor Cover	1	24*	Tension Spring	1
3	Power Cord	1	25*	Retaining Ring	1
4	Top Housing	1	26*	Lower Knob	1
5	Switch Plate	1	27*	Screw	1
6	Lock Stop	1	28*	Bolt	1
7	Grinding Wheel Base	1	29*	Chain Saw Frame	1
8	Grinding Wheel	1	30*	Square Neck Screw	2
9	Grinder Lock Cap	1	31*	Sliding Guide	2
10	Screw	2	32*	Pad	2
11	Grinding Wheel Cover	1	33*	Screw	1
12	PCB	2	34*	Handle	1
13	Punching Axis	1	35*	Spring	1
14	Torsion Spring	1	36*	Lock Screw	1
15	Switch	1	37	Retaining Ring(10)	2
16	Nut	1	38	Motor	1
17	Base	1	39*	Waher	1
18	Lock Wheel	1	40*	Nut	1
19*	Screw	1	41	Fuse Components	1
20*	Washer		42	Screw	2
21*	Bearing		43	conductor	1
22*	Swing Arm				

The Chain Mounting Assembly (#39) is only available as a set. It includes all part numbers with asterisks(*). Part numbers with asterisks (19 through 36) are not available individually.

NOTES: