

**For over
three decades,**

DIG has been providing homeowners, landscapers and growers with innovative, high-quality, low-volume, drip irrigation products.

At DIG, our primary focus is providing you the highest quality irrigation products along with unmatched customer service. We thank you very much for your business and welcome any questions or comments.

For answers to questions regarding the design of a drip irrigation system, or to obtain more information about DIG irrigation products, please contact Technical Service at 800.344.2281 or by email at questions@digcorp.com.

Visit Us!



1210 Activity Drive • Vista, California 92081-8510
©2021 All Rights Reserved. Catalog 19-001
We at DIG strongly believe in recycling. Please recycle.



Take One
FREE

DRIP IRRIGATION GUIDE

How to get up and running
using waterwise drip irrigation



WATER MATTERS

Drip irrigation is a cost-effective and water-efficient way to keep your landscape green and beautiful!



Water Matters with DIG

DIG provides simple and smart irrigation solutions to help your landscape thrive. Our eco-friendly technologies are designed to save you time, money and water. Before you begin setting up and implementing your water-saving drip system, we suggest that you familiarize yourself with the basics of drip.



What is drip irrigation?

Drip irrigation is a type of watering system that applies a small amount of water to keep plants healthy and hydrated. Drip irrigation slowly delivers a precise amount of water directly to plant root zones, enabling them to thrive in a healthy environment with a consistent moisture level.



Why use drip irrigation?

Drip irrigation uses 50% to 70% less water than conventional sprinklers, lowering your water bill and helping our planet! Since drip irrigation uses a small amount of water, slowly and precisely, there is very little water waste due to evaporation or ground-water runoff. Drip irrigation prevents overwatering and reduces the unwanted weed growth, mold and mildew that can occur with regular sprinklers. All in all, drip irrigation is a cost-effective and water-efficient way to keep your landscape green and beautiful!

THE MANY ADVANTAGES OF DRIP IRRIGATION

Healthy plants

Flowers, trees, shrubs, vegetables and potted plants can all thrive with drip.



Efficiency

Slow, precise and consistent drip irrigation delivers water directly to plant root zones exactly where it's needed most. With drip irrigation, less water is lost to evaporation and ground-water runoff than with regular sprinklers.

Reduced pest problems and weed growth

By applying water only to the plant root zones, drip irrigation reduces weed germination, water borne pests and fungal diseases.

Versatility

Hills, oddly shaped landscapes and plants that require varying amounts of water can all easily be accommodated with DIG's line of drip irrigation products and systems.

Easy installation

No special tools or glue are needed. Installation is simple.



TABLE OF CONTENTS

Easy to Use Color Coded System	1–2
Water Connections.....	3–6
System Layout	7–8
Assemble Your System	9–10
Drippers (Drip emitters).....	11–12
Micro Sprayers.....	13–16
Dripline & Soaker Hose.....	17–18
Layout Schemes	19–20
Layout Examples.....	21–24
Drip Irrigation Starter Kits.....	25
Watering Timers.....	26
Planning.....	27–32
Charts.....	33–34
Installation.....	35–42
Glossary.....	43
Quick Reference Index.....	44–48

EASY TO USE COLOR CODED SYSTEM

Locate your products

DIG simplifies the buying process by using a clear, easy-to-read color coding system and descriptive categories on all box front labels as well as product bags.

5 color coded categories:

Water Connections™

Fittings™

Drippers™

Micro Sprayers™

Accessories™



Locator numbers 39

Poly tubing



Water Connections

Choose from a variety of connections, whether hose or pipe thread, to start a drip system. Also, easily convert existing irrigation systems to efficient water saving drip systems with DIG's retrofit products.

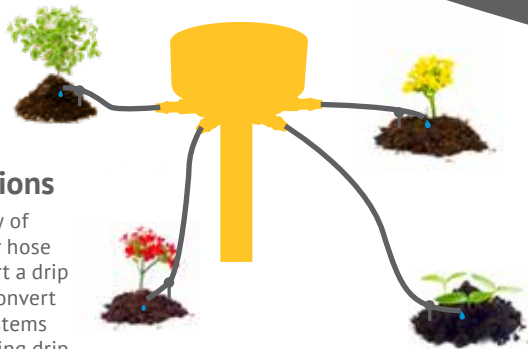

Fittings

No clamps or glue required. Join tubing securely using DIG's complete line of barbed, compression or universal nut-lock fittings.



Drippers (Drip Emitters)

Precise, efficient and economical, DIG's extensive line of drip emitters provides a variety of flow rates to deliver a precise amount of water exactly where you need it!

Microtubing



Accessories

Hose ends, plugs, ball valves, clamps, punches, insertion tools, tubing holder stakes and more –whatever accessories you need to customize your drip irrigation system, DIG has got you covered!



Micro Sprayers

Conserve water and keep your landscape thriving with DIG's low-volume micro sprayers, micro sprinklers and foggers.

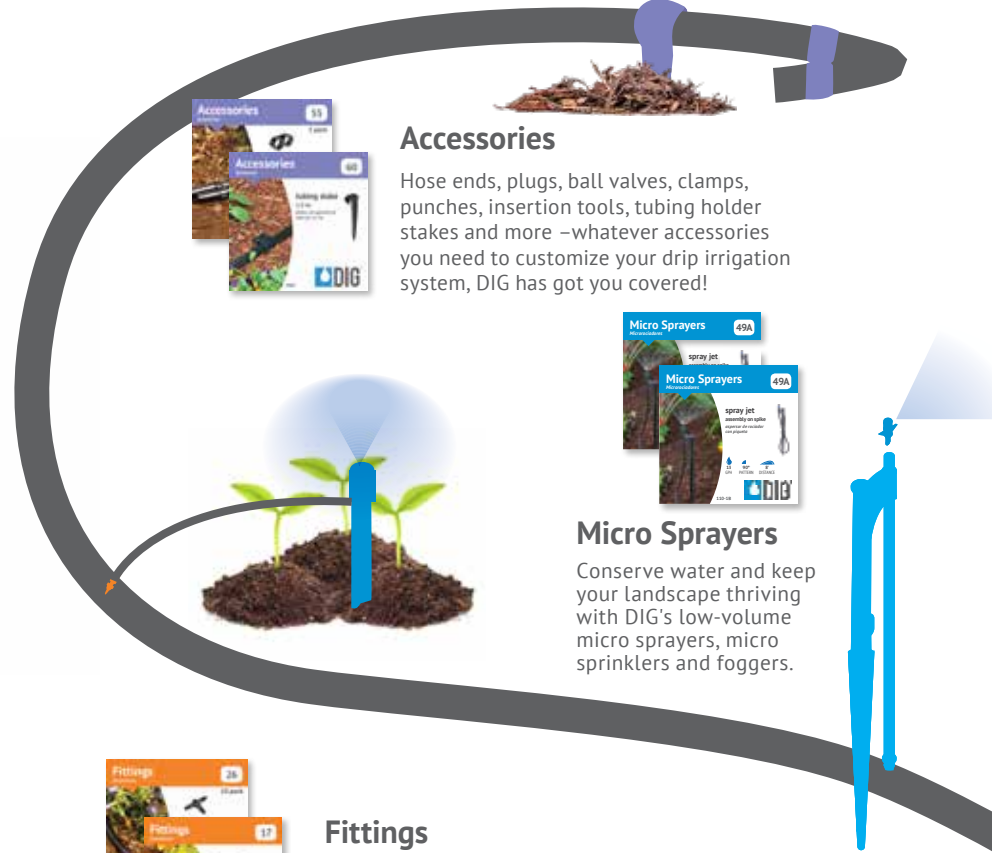

WATER CONNECTIONS

How to Start a Drip Irrigation System

A properly designed drip system begins with the drip zone head assembly which consists of a filter and a pressure regulator. The filter protects from small debris or dirt clogging the water passage to the drip emitters or micro sprinklers, and the pressure regulator reduces the incoming pressure to the appropriate operating pressure range. This assembly can be attached to a faucet, anti-siphon valve, manual or automatic inline valve, or to a sprinkler riser.

In some regions, a backflow preventer is required to meet city codes. A backflow preventer keeps water from re-entering the household water supply.

Connecting drip zone head assembly to an outdoor faucet

This is the simplest way to install a drip system and can be easily automated by adding one of our battery or solar powered timers, models [RBC 7000](#), [EVO100](#), [BO9DB](#), [B092A](#) or [BOHE-BT Bluetooth®](#). All models listed have "hose" type threads and should be hand tightened only.

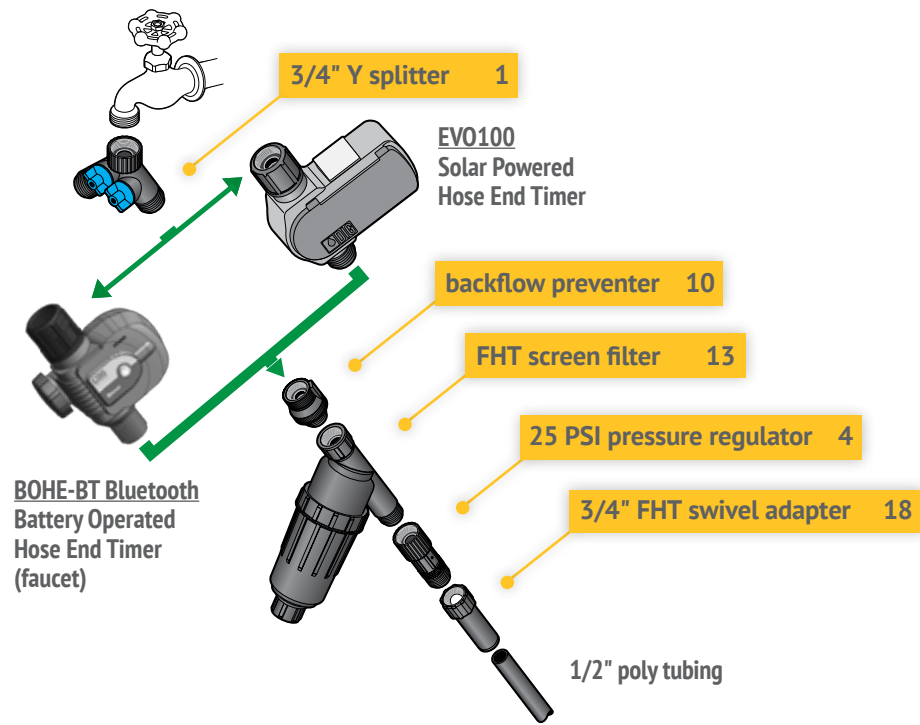

◀ Look for this color code:

Water Connections 13

Or match locator numbers. ▲



Connecting drip zone head assembly to an anti-siphon valve

This installation must be installed at least 6" above the highest point in the garden and can be automated by adding one of our battery or solar powered timers with a 3/4" anti-siphon valve, models [RBC 8000](#) or [ECO1 ASV.075](#). All models listed have "pipe" type threads and generally require three to five rounds of TEFLON tape to seal; wrench tightening may be necessary.

ECO1 ASV.075
Solar Powered Timer
with 3/4" Anti-Siphon Valve

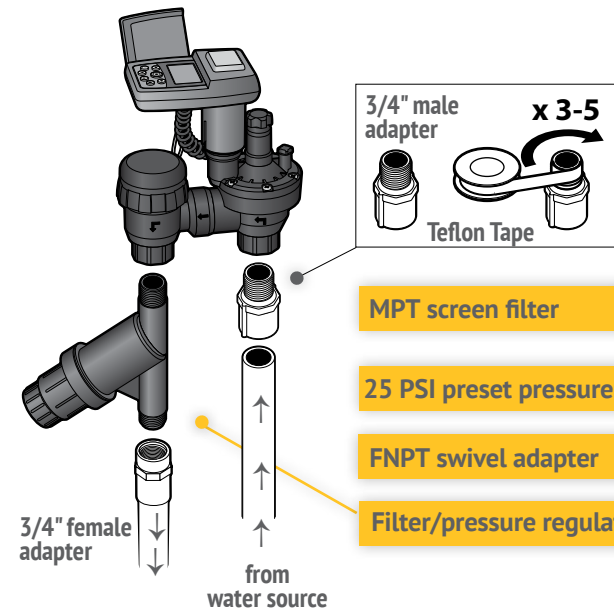

RBC 8000
Battery Powered Timer
with 3/4" Anti-Siphon Valve

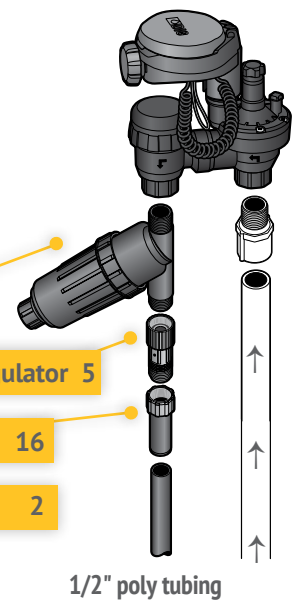

WATER CONNECTIONS

Connecting drip zone head assembly with an inline valve

This below-grade, inside-a-valve-box installation from a PVC pipe can be automated by adding one of our battery powered timers or 24VAC valve assemblies, models RBC 7000 or DM075. All models listed have "pipe" type threads and generally require three to five rounds of TEFLON tape to seal; wrench tightening may be necessary.

RBC 7000

Battery powered timer with 3/4" inline valve

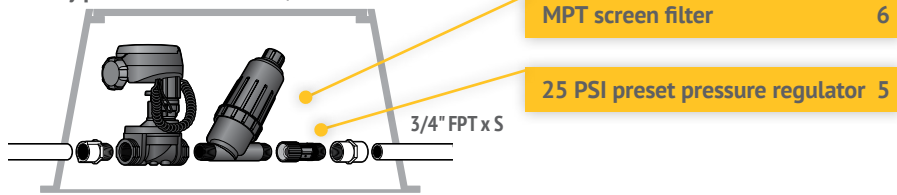

MPT screen filter 6

25 PSI preset pressure regulator 5

3/4" FPT x S

DM075

24 VAC with 3/4" inline valve drip zone assembly

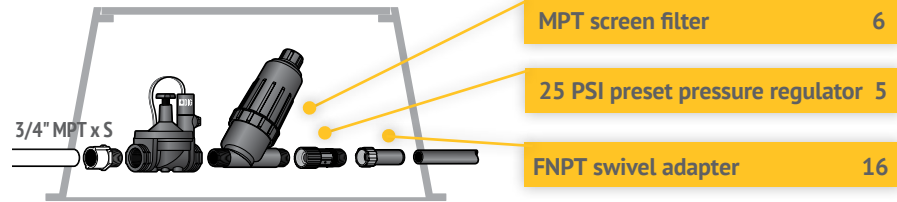

MPT screen filter 6

25 PSI preset pressure regulator 5

3/4" MPT x S

FNPT swivel adapter 16

Connecting drip zone head assembly into a 1/2" sprinkler riser

This installation retrofits a 1/2" riser into a drip system by serving as a point of connection for PC dripline or 1/2" drip tubing. The complete assembly is available in model DSR, and can be used for above or below ground layout of dripline or drip tubing.

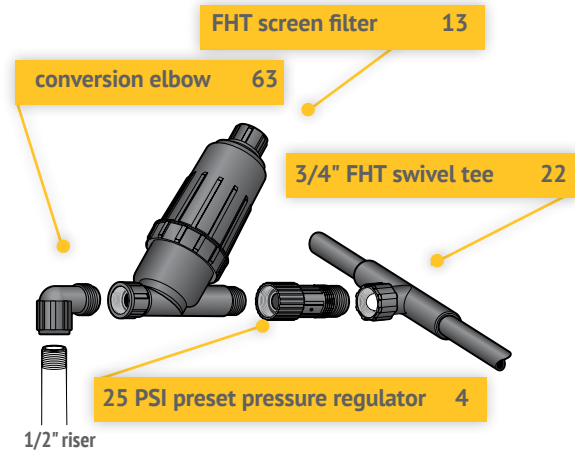

FHT screen filter 13

conversion elbow 63

3/4" FHT swivel tee 22

25 PSI preset pressure regulator 4

1/2" riser

25 PSI drip conversion kit 3



Connecting a multi-outlet drip manifold to a 1/2" sprinkler riser

This installation retrofits a 1/2" sprinkler riser into a multi-outlet drip manifold head by removing the sprinkler head from the riser and attaching a 2-, 4-, 6- or 12-outlet PC drip manifold head. From the drip manifold head, extend the micro tubing to the plants and secure the end with a stake.

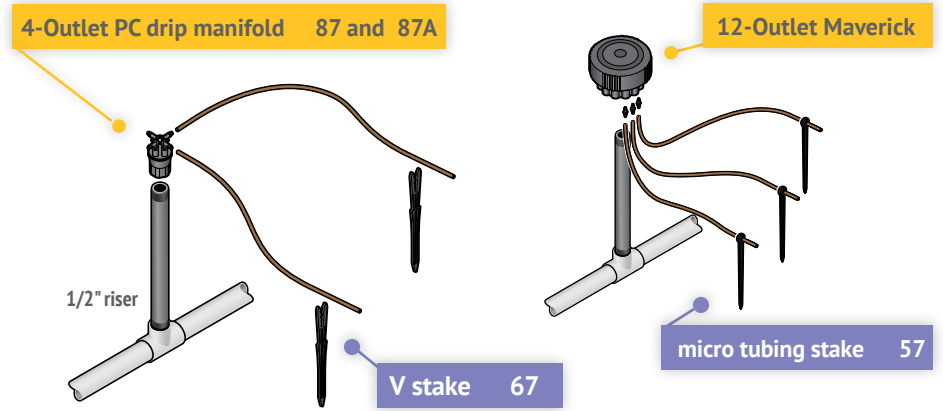

4-Outlet PC drip manifold 87 and 87A

12-Outlet Maverick

1/2" riser

V stake 67

micro tubing stake 57

6-Outlet PC drip manifold 89

Adj. 6-Outlet PC drip manifold 86



Adj. dripper on spike 39A

V stake 67

1-Pint Fertilizer Injector

Economical, flexible and easy-to-use, the Add-It™ Automatic Proportional Fertilizer Injector with or without a backflow device is ideal for residential applications, including feeding lawns, shrubs, trees, flowers, raised beds, vines and potted plants automatically without a pump, spreaders or hoses.



Add-It™ Fertilizer Injector

SYSTEM LAYOUT

Poly Tubing and Micro Tubing

DIG's flexible poly tubing and micro tubing are installed above or below the soil's surface and are connected into the drip zone head assembly. Extruded from the highest-quality linear, low-density polyethylene resin (with carbon black for extra protection from the damaging effect of ultraviolet light), the drip tubing and micro tubing are designed to meet every demand of drip irrigation projects from backyard garden installations to commercial sites.



◀ Look for this color code:

Tubing

To ensure problem-free installation and use, we recommend using DIG's premium 1/2" .700 OD poly tubing. In the event that another size of tubing is used, DIG offers various sizes of compression fittings, barbs and universal fittings to complete the installation.

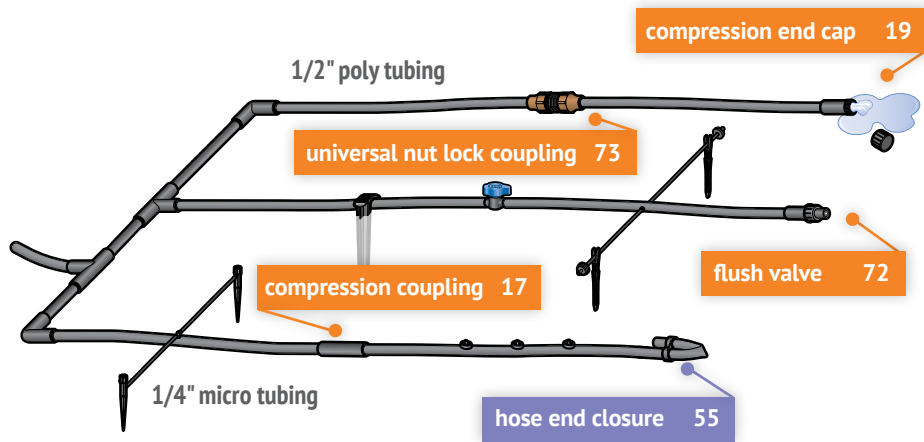

Poly Tubing

DIG's premium poly tubing is used as the primary supply line for drip irrigation into which the micro tubing, drippers, micro sprinklers, micro sprayers or dripline are linked to deliver water to the plants. The poly tubing is available in 50', 100', 200' and 500' coils and uses DIG's .700" OD compression fittings (black). If drip tubing with .710" OD is utilized, use the .710" OD fittings with a blue insert. Maximum operating pressure is 60 PSI and max. flow rate is 220 GPH (3.6 GPM).



Micro Tubing

The 1/4" micro tubing serves as the feeder line to the drippers, misters or micro sprayers, or as an extension to the plants from the 4-, 6- and 12-outlet drip manifolds. It may also be used as the basis for a complete system for hanging baskets, containers or for a patio garden (see FM01AS starter kit). The micro tubing is available in vinyl or polyethylene in 50', 100' and 500' coils and uses DIG's 1/4" barbed fittings. Maximum operating pressure is 60 PSI and maximum flow rate is 15 GPH (.25 GPM).

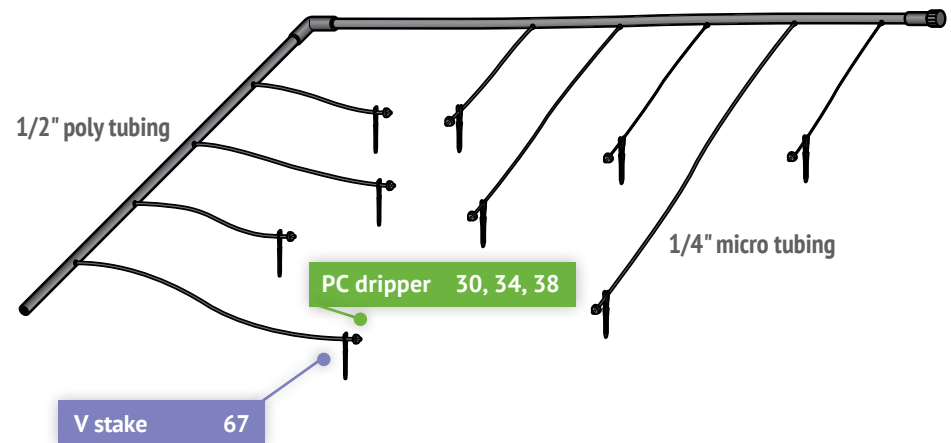

ASSEMBLE YOUR SYSTEM

Drip Fittings and Accessories

DIG's complete line of drip fittings and accessories make it easy to assemble and install a complete drip irrigation system; no special tools or glue are required.



◀ Look for these color codes:

Fittings	25
Accessories	52

Or match locator numbers ▲

1/4" Fittings

1/4" barbed fittings are used to join segments of 1/4" micro tubing or dripline together, or to connect 1/4" micro tubing or dripline into 1/2" poly tubing.

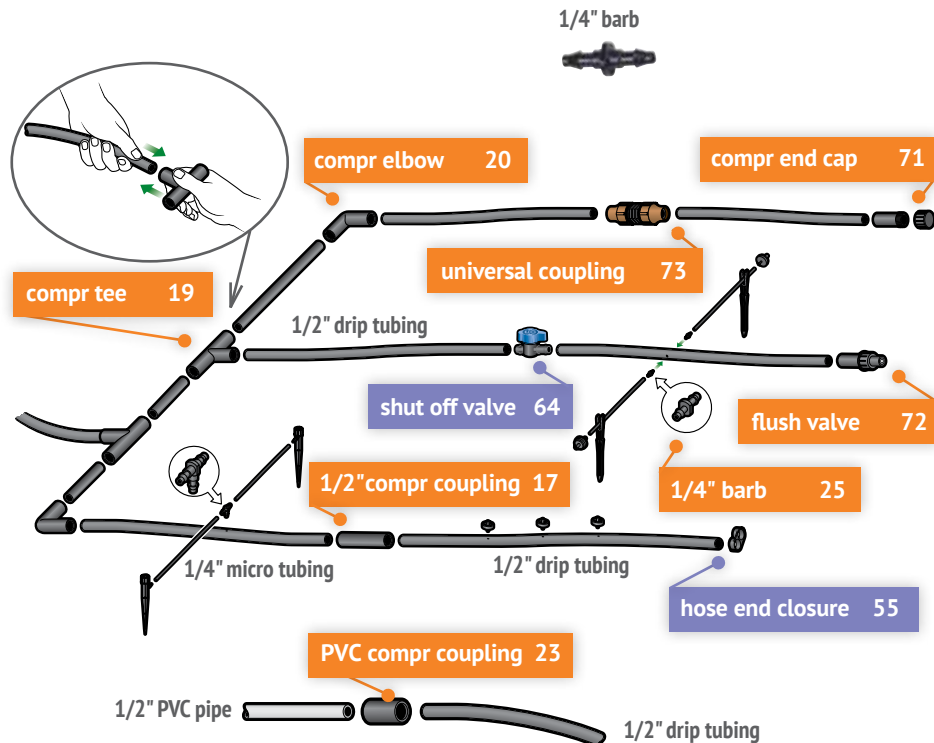

1/2" Fittings

The 1/2" fittings are available in three types: **compression**, **universal** and **barbed**. **Compression fittings** fit over the poly tubing; the poly tubing is compressed when it is forced into the fittings by moving it up and down or "walking" it in. Use the compression fittings with black inserts for DIG's .700" OD poly tubing and blue inserts for .710" poly tubing. If the outside diameter of the poly tubing is not known, or if it is necessary to connect different sizes of poly tubing segments together, it's best to use the **universal nut lock™ fittings**, which can be re-used and will fit all sizes of .630" OD to .710" OD. DIG also provides brown 1/2" **barbed fittings**, which can be used with our brown 1/2" PC dripline (B18100) or others. These fittings are installed in the same way as the 1/4" barbs, by forcing the barb into the end of the 1/2" dripline.

1/2" compression



1/2" barb



1/2" universal nut lock™



Accessories

DIG's full line of drip accessories make it easy to maintain, customize and finish off the system installation. Our line-up includes goof plugs and hose ends to close off the lines, stakes and C clamps to keep the tubing in place, and also punches and insertion tools to speed up and simplify the installation.

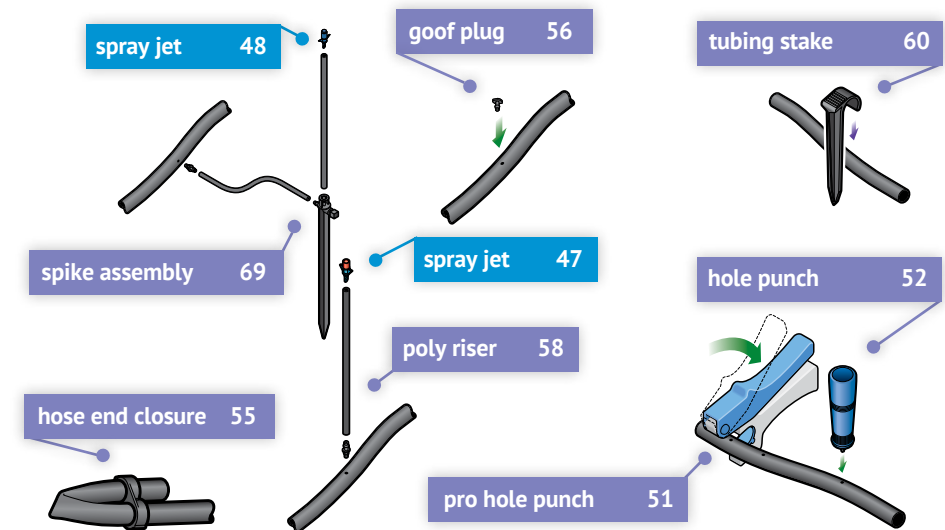

DRIPPERS (DRIP EMITTERS)

Drippers

DIG drippers are ideal for installations in both residential and commercial applications. They are classified into groups of **pressure compensating (PC)**, **non-compensating** (button, flag, inline) and **adjustable**. When you are ready to install or extend your drip irrigation system, you may be surprised that there are so many different types of drippers, flow rates and shapes. What should you use, at what flow rate, and how many will you need? This section clarifies how to select the right dripper for your garden.



◀ Look for this color code:

Drippers 29

Or match locator numbers. ▲

Pressure Compensating (PC) Drippers

The PC drippers contain a diaphragm that continuously adjusts to incoming water pressures while maintaining an even flow rate. The PC-CV has a special water saving feature that eliminates water drainage when the system is shut off and the pressure drops below 3 PSI. The PC drippers are available in 1, 2 and 4 GPH on a barb, .5 and 1 GPH on a barb with a built-in CV (check valve), and 1 and 2 GPH on a spike.

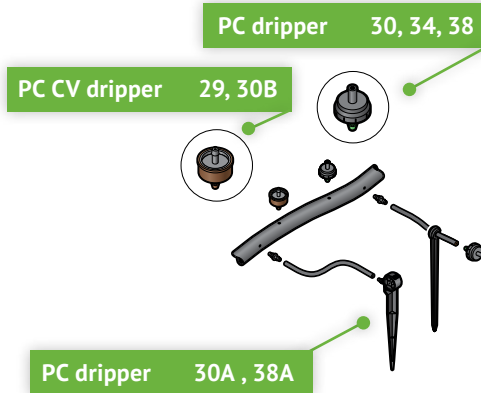

Button Drippers

Button drippers are available in .5, 1 or 2 GPH and operate at a pressure range of 15 to 25 PSI. They are good for sites with flat terrain, for short distances and for gravity feed systems on any type of planting. These drippers can be taken apart for cleaning by unscrewing the outlet from the base.

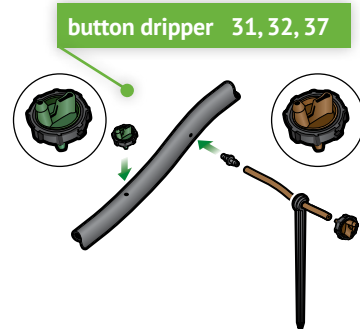

Flag Drippers

Flag drippers are available in 1, 2 or 4 GPH and operate at a pressure range of 15 to 25 PSI. They are typically installed directly on top of the 1/2" poly tubing and the stem of the drip emitter may be twisted open for cleaning. If necessary, 1/4" micro tubing can be connected to the outlet to reach plants not adjacent to the 1/2" line. Flag drippers can be used for small systems with short planting run, for flat terrain, and with low-pressure gravity feed systems.

flag dripper 33, 35, 36

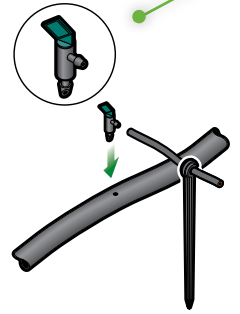

Inline Drippers

Inline drippers are available in .5 or 1 GPH and operate at a pressure range of 15 to 25 PSI. The barbed inlet and outlet are spliced into a single 1/4" line to wrap around plants or lay out in a straight line inside boxes and containers. The end of the line must be closed with a goof plug.

inline drippers 31, 37

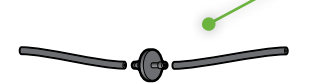

Adjustable Drippers

Adjustable stream drippers flow from 0 to 14 GPH @ 25 PSI and offer a gentle stream pattern in 180° or 360°. The flow rate, as well as the radius of the wetted area are adjustable by rotating the cap towards the plus or minus sign to lower or increase the flow. These drippers are available with barb or on a spike, and are used to water an individual shrub, planter boxes or a group of plants.

adj. dripper 39

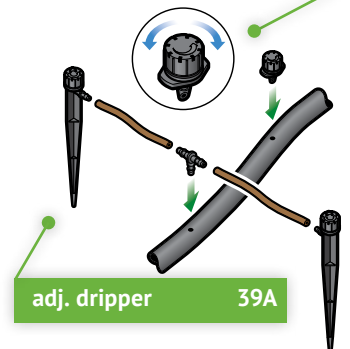

Adjustable Bubbler

The adjustable bubbler on a spike flows from 0 to 28 GPH @ 25 PSI and provides a gentle stream umbrella pattern. The bubbler flow rate, as well as the radius of the wetted area are adjustable by rotating the cap towards the plus or minus sign to lower or increase the flow.

adj. bubbler 102



MICRO SPRAYERS

Micro Sprayers, Micro Sprinklers and Foggers

DIG provides a wide range of micro sprayers, micro sprinklers and foggers—all designed to provide a low-volume, water-saving alternative to traditional sprinklers or for areas where drippers are not practical. These products provide a much slower application of water over typical sprinklers which allows for maximum soil absorption, helping to eliminate runoff and increase plant health.

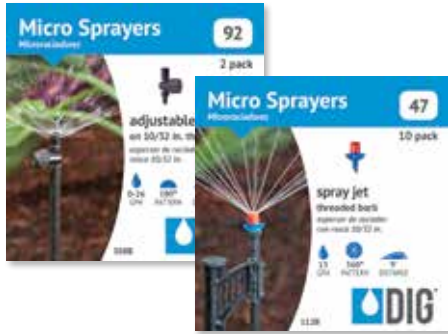

◀ Look for this color code:

Micro Sprayers 47

▲ Or match locator numbers

Micro Sprinkler

The multi-purpose and versatile micro sprinkler with interchangeable spray heads provides gentle droplets and a consistent pattern of up to 25' in full circle. It is a great choice for watering flowerbeds, groundcovers and under tree canopies. For the ideal coverage, simply install the appropriate spray head.



micro sprinkler 40

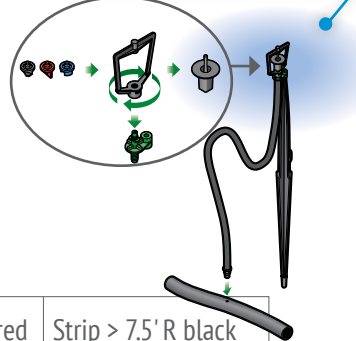

18 GPH 360° > 25' 180° > 5.3' R blue 90° > 10' R red Strip > 7.5' R black

Fogger/Mister

The fogger/mister with a threaded barb uses a vortex nozzle to create a fine and even spray pattern. It is used with a universal spike, adjustable stake or poly riser and is ideal for tropical plants, flowerbeds, seed germination and planter boxes.

5-7 GPH 360° > 4-6'

fogger mister 43



Pot and Basket Mister

The pot and basket mister is ideal for misting or watering pots and hanging baskets. The vortex design spins the water droplets into a fine mist, producing micro-sized droplets in a small diameter area. Use it inside a pot by attaching it to a stake, or above the plants using the flex tubing mister.

2 GPH 360° > 2'

shut off valve 65

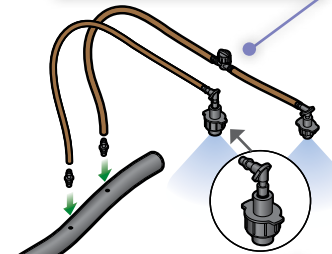

pot and basket mister 46B

Micro Sprayer Jets

The sprayer jets with a threaded barb, or assembled with a 13" stake, produce spray streams in a range of patterns. They can be used for groundcover, flowerbeds and under trees with a spacing of four to eight feet apart.

13 GPH 360° > 18' red 180° > 7' R blue 90° > 8' R black

micro sprayers 47 48 49

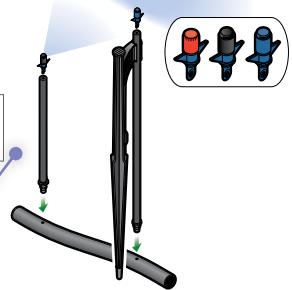

poly riser 58

MICRO SPRAYERS

Fan Sprayer Jets

The fan sprayers, assembled with 13" stakes, produce a low angle fan spray in a range of patterns. They can be used for groundcover, flowerbeds, hedges, perennials and under trees. Apply them in a spacing of three to five feet apart.

fan sprayer jets 47D 48D 49D



40 GPH 360° > 11' red 21 GPH 180° > 6' R green

8 GPH 90° > 4' R blue

Adjustable Micro Sprayer Jets

The adjustable micro sprayer jets are available with 10-32 thread or assembled with 13" stakes. They produce a spray jet pattern in full, half and quarter circles. The flow rate, as well as the radius of the wetted area are adjustable by rotating the cap towards the plus or minus sign to lower or increase the flow. They can be used for groundcover, flowerbeds, hedges, perennials and under trees with a spacing of five to eight feet apart.

spray jet 91, 92, 93



0-26 GPH 360° > 21' 180° > 10' R 90° > 9' R

Mini Sprinkler

The mini sprinkler is assembled with micro tubing and a 13" stake. It produces a low-trajectory and high-uniformity spray coverage with a low precipitation rate. Easy to install, the mini sprinkler is highly recommended for use in flowerbeds, seedling beds, groundcovers or under tree canopies.

mini sprinkler 95



22 GPH 360° > 14' green

Fogger

The fogger with a barb is ideal for misting, humidifying and cooling in residential gardens and greenhouses. The vortex design spins the water droplets into a very fine mist, producing micro-sized droplets. It can be used to reduce temperature, to humidify, or for where overhead watering is suggested.

2 GPH 360° > 2'

fogger

99



Flow Regulated Micro Sprinkler

The flow regulated micro sprinkler with micro tubing and a 13" stake is designed to achieve consistent flow rates and even uniformity in areas where pressure fluctuates, such as hillsides and on difficult terrain. The insect-proof micro sprinkler operates under a wide range of pressures from 20 to 50 PSI. It can be used for flowerbeds, seedling beds, ground covers or under tree canopies.

7 GPH 360° > 16'

flow reg. micro sprinkler 100



Adjustable Vortex Micro Sprayer

The adjustable micro sprayer on a 6" stake produces an inverted umbrella spray pattern. The flow rate, as well as the radius of the wetted area, are easily adjusted by rotating the cap towards the plus or minus sign to lower or increase the flow. It can be used for shrubs, flowerbeds, between groups of plants and under small trees.

0-20 GPH 360° > 0-12'

micro sprayers

101

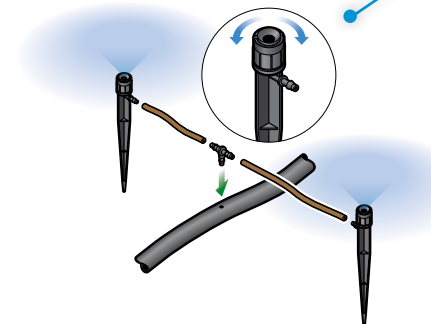

DRIPLINE & SOAKER HOSE

Dripline and Soaker Hose

DIG's dripline and soaker hose are specifically designed to efficiently irrigate groups of plants, vegetable gardens, or individual shrubs or trees. The 1/2" PC dripline and soaker tape are best used for hedge rows and long runs. The 1/4" microline dripline and porous soaker hose are ideal for watering raised beds, vegetable gardens, large containers and flower beds. All of these products saturate the soil underneath the entire length of the line.



Look for this color code:

Dripline

Earthline™ Brown PC Dripline

Earthline™ Brown PC dripline has built-in 1 GPH PC (pressure compensating) drippers in the interior wall of the tubing every 12" or 18". Each emitter has two outlets. If one outlet becomes blocked, a second outlet on the opposing side of the dripline provides redundancy to the dripline performance. The drip emitters continuously adjust to varying incoming water pressures and ensure a constant flow rate regardless of elevation along the line. The drip emitter's self-flushing mode allows particles to flush through, providing reliable performance and longer life. Use 1/2" barbed fittings with this dripline and do not exceed a maximum recommended length of 369'.

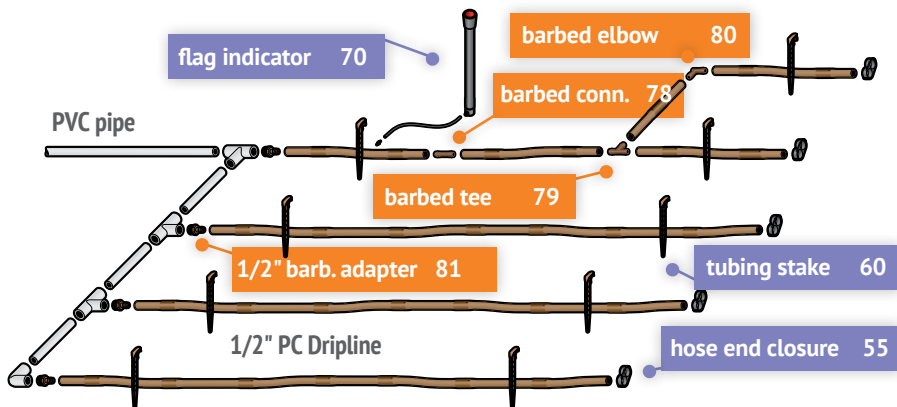

Microline™ Dripline

Microline™ dripline is 1/4" micro tubing with .6 GPH @ 25 PSI drippers built into the wall of the micro tubing at intervals of 6, 9 or 12 inches. It can be used for vegetable gardens, window boxes, narrow paths of planted area or wherever total saturation is required.

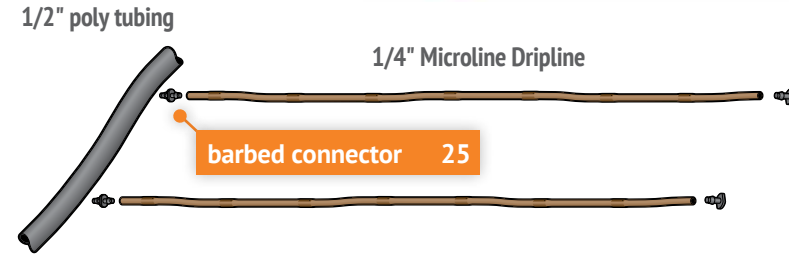

Porous Soaker Hose

The 1/4" porous soaker hose is made from UV-resistant recycled rubber that provides 1.3 gallon per foot @ 25 PSI. It can be used for very short lines of up to 15 feet for row plantings, containers or planter boxes, and it can be connected with 1/4" barbed fittings.

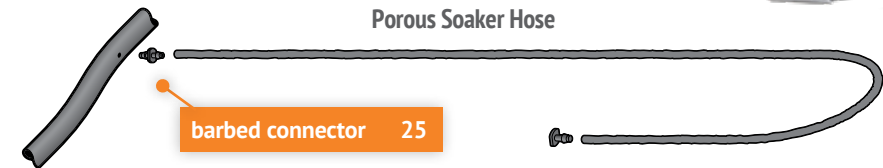

Drip Soaker Tape

Drip soaker tape is an economical thin-walled drip soaker line designed for vegetable rows. The .6 GPH @ 25 PSI built-in drippers are spaced every 12" and used with soaker tape fittings #'s 27, 28, 29, 76 to a maximum recommended length of 280'.



LAYOUT SCHEMES

Hills & slopes

Applying water to your plants only where it is needed, DIG's drip system slowly and directly waters plants' roots resulting in less water lost to runoff, evaporation and wind.

Recommended product:

1/2" brown PC dripline

Shrubs & trees

A healthy root zone for your trees and shrubs is essential to their growth and stability. DIG's drip system assists in establishing strong and healthy root zones by maintaining optimum soil moisture levels while saving water.

Recommended product:

Maverick 12-outlet manifold

Flourishing flower pots

DIG's adjustable sprayers and PC drippers offer excellent solutions for controlled amounts of water and maximum soil absorption—use under canopies of large shrubs.

Recommended product:

adj. dripper 39A

PC drippers 30, 34, 38

button drippers 31, 32, 37

Healthier vegetable gardens

DIG's drip systems target the root area, helping to reduce pests and weed growth while increasing yields.

Recommended product:

1/4" micro dripline

Creative spaces

Flower beds and border plantings can often benefit from overhead watering. DIG's micro sprayers provide a slow application of water which promotes plant health and sustainability.

Recommended product:

spray jet 47, 48, 49

adj. spray jet 91, 93

LAYOUT EXAMPLES

Grow Like a Pro

From potted plants to rose gardens, and everything in between, we're here to help you keep your plants healthy and strong. Watch your garden flourish with drip irrigation, without wasting water or breaking the bank.

Mixed plantings, roses, trees, vines and shrubs

Low application rate, pressure compensating (PC), button, flag, and adjustable drippers, and PC dripline are suited for virtually any layout with mixed plantings or oddly shaped areas and areas with high winds. These can include shrubs, groundcover, trees, vines, roses and more. Drippers and dripline are most efficiently used when plants are spaced a few feet apart or in a small group.

Ideal for this area:

- Pressure compensating (PC), button, adjustable, or flag drippers (#30 to #39)
- 1/2" brown PC dripline is suited for virtually any layout

A layout for mixed plantings, roses, trees, vines and shrubs



Flowerbeds, perennials and groundcover

Densely planted areas such as flowerbeds, annuals, groundcovers and plant clusters thrive with micro sprayers and micro sprinklers. These products are also perfect for slopes, narrow or curved landscapes and sites with sandy or lightly textured soil.

Ideal for this area:

- Micro sprinklers for full coverage (#40, #95, and #100)
- Adjustable micro sprayers (#91, #92 and #93) or preset micro sprayers (#43, #47, #48, #49 full range and #101) to water a selected section or area



A layout for flowerbeds, perennials and groundcover



LAYOUT EXAMPLES

Container plants, raised beds, hanging baskets, pots & window boxes

Low application rate .5 and 1 GPH button drippers, 1/4" dripline, 1/4" soaker hose or misters are highly recommended for any layout with containers, raised beds, pots, baskets and window boxes. Foggers can also be used inside greenhouses for pots and hanging baskets when above-watering is desired. Potting soils are very porous and water can move downward quickly, so the correct emission device is critical, depending on plant size. We recommend dividing the containers, pots and hanging baskets into groups with similar sizes and similar watering needs. We also suggest dividing the containers, pots, baskets and window boxes into groups that are either in full sun or in shaded areas.

Ideal for this area:

- Low application rate .5 and 1 GPH button drippers (#30 to #37)
- 1/4" dripline (both porous and non-porous) with dripper spacings of 6", 9" or 12"
- 1/4" porous soaker hose
- Misters (#46, #99)
- Inline drippers (#31A, #37A)

A layout for raised beds, hanging baskets, pots & window boxes



Vegetable gardens, planter boxes and row crops

Low application rate drippers, 1/4" dripline, 1/2" brown PC™ dripline and drip soaker hose are suggested for vegetable gardens, row crops, seed beds, planter boxes and fruit trees. Combining drip irrigation with raised beds and mulch can enhance crop uniformity and encourage early harvest time. These products have the drippers inserted or molded into the drip tubing in a preset spacing of 6", 9", 12" or 18". Vegetable farms and raised beds often use closely spaced driplines to achieve desired wetting patterns. This saturates the soil under the length of the dripline or soaker hose, creating uniformity and growth along the dripline. Drip irrigation can be used in certified organic production. In some instances, the certifying agency may request a water analysis. For more information, please visit the National Organic Program (NOP) at www.ams.usda.gov/NOP

Ideal for this area:

- Low application rate .5 and 1 GPH button drippers (#30, #31, #37)
- 1/4" dripline with a dripper spacing of 6", 9" or 12"
- Brown PC™ dripline with 18" spacing
- Drip soaker hose

A layout for vegetable gardens, planter boxes and row crops



DRIP STARTER KITS

Water-Saving Kits for Every Landscape

Any of DIG's kits can be easily automated by adding a battery or solar powered hose end timer.



G77AS, Landscape Drip Watering Kit

Perfect for first time users. Everything included for irrigating ground-cover, shrubs, trees, flowers, roses, vegetable gardens and vines.



ML50, Garden Dripline Watering Kit

The vegetable garden drip irrigation kit is a perfect choice for watering vegetable gardens or any row plantings. Covers up to 150 sq ft and is expandable.



GD50, PC Dripline Watering Kit

The GD50 kit provides 50' of dripline with pre-inserted 1 GPH pressure compensating drippers every 18" for quick and easy installation.



FM01AS, Patio Drip Watering Kit

Ideal for smaller applications. Everything included to water pots, planter boxes and containers. Covers up to 15 small-to-medium-sized pots or baskets.



PC14100, Drip Manifold Kit

The 12-Outlet High Flow Drip Manifold Kit is designed to convert an existing 1/2" sprinkler riser into a 12-outlet drip irrigation system.



GE200, Drip & Micro Sprayer Kit

Our largest and most versatile kit that combines both drip and micro sprayers to accommodate any landscape needs. Covers up to 700 sq ft and is expandable.



SM500, Adjustable Micro Sprayers Kit

Water saving adjustable micro sprayer system. Ideal for flowerbeds, groundcovers, borders and under canopies.

WATERING TIMERS

Automate Your System

DIG's innovative line of watering timers takes the daily hassle out of watering so less time is spent watering and more time is spent enjoying the garden. No matter how simple or intricate the watering schedule requirements, DIG has the perfect timer to suit the needs of any landscape!



RBC 7000



Bluetooth® Hose End Timers

Control any number of DIG Bluetooth hose end timers through supported Android or iPhone smart devices from up to 50' (15 m), line of sight. **Models:** BOHE-BT



Solar Powered Hose End Timers

No direct sunlight needed! Easily attaches to any standard faucet for automatic watering and offers versatile programming options. Ideal for both drip and sprinkler systems. **Models:** EVO 100



Digital Hose End Timers

Battery operated timer with LCD display features an instant manual irrigation cycle. Durable and weather resistant; programming options include up to four start times per day. **Model:** BO9D, BO9DB



Two Dial Digital Hose End Timers

Battery operated timer with LCD display features an instant manual irrigation cycle. Durable and weather resistant; programming options include up to four start times per day. **Model:** BO92A



Single Station Solar Powered Timers

No electrical wires or batteries required. With its SimpleSmart™ technology, it adjusts watering schedules monthly to help eliminate over or under watering, ensuring a healthy landscape. **Models:** ECO1 ASV.75, ECO1 ILV.075



Single Station Battery Powered Timers

Ideal solution for irrigation control when AC power is not available or when adding additional valves. Fully waterproof with versatile programming options, used for both drip and sprinkler systems. **Models:** RBC MVA, RBC 7000, RBC 8000

PLANNING



STEP 1 Sketch the Area. Make an accurate top view sketch of the areas to be watered. Ensure that the outline includes your home, any retaining walls, paved areas and water sources accurately and to scale. This will require measuring the area. We recommend using the graph paper to make drawing to scale easier. Each small square on this manual graph can represent one foot of your property (usually appropriate for residential landscapes), or you can use 1" graph = 10' of your area.

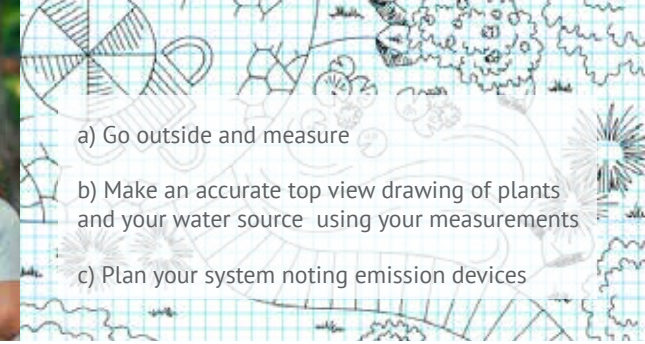

- a) Go outside and measure
- b) Make an accurate top view drawing of plants and your water source using your measurements
- c) Plan your system noting emission devices

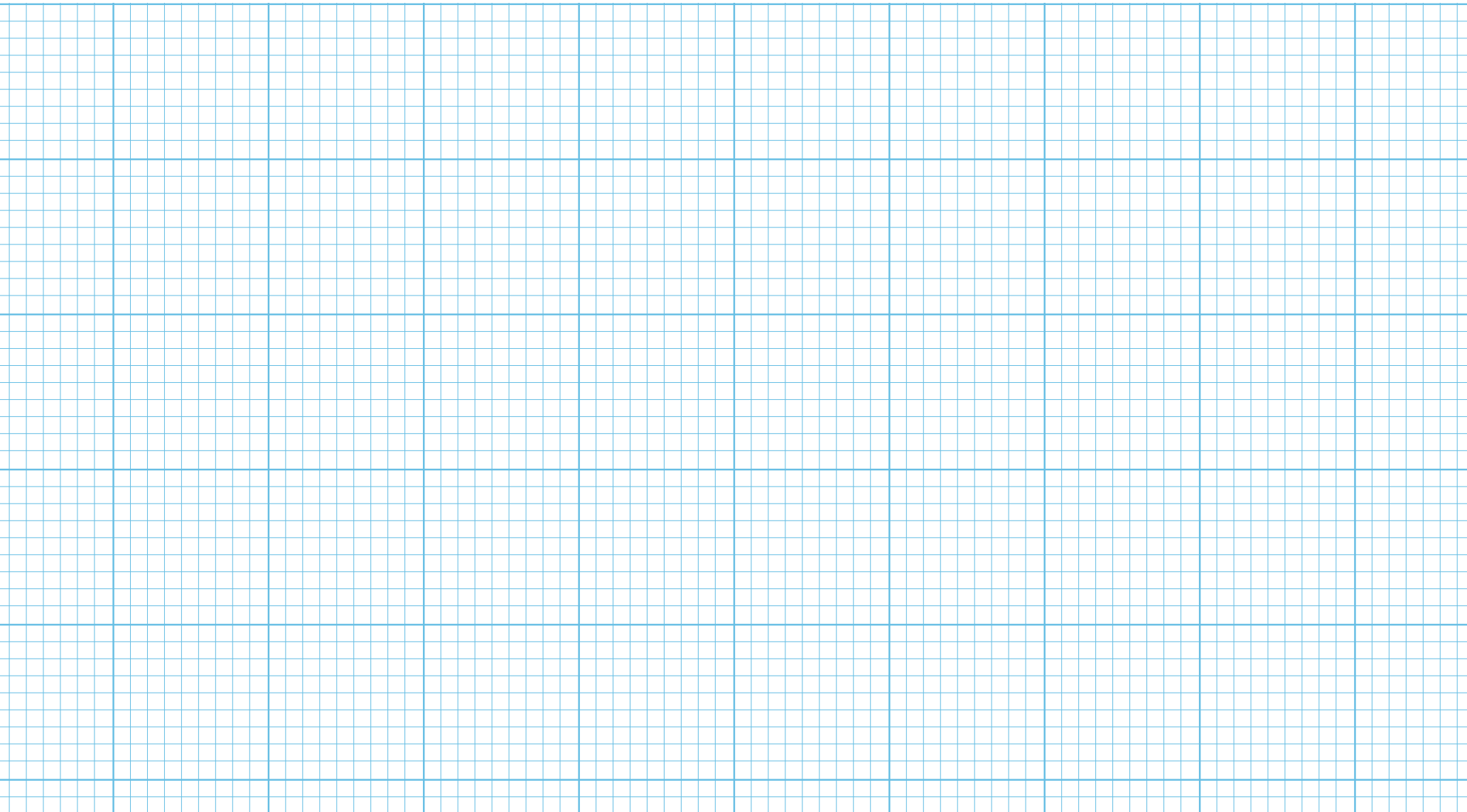

PLANNING

Getting Started

When installing a water-saving drip irrigation system, it's essential to plan ahead before you start the installation. To make planning as convenient as possible, we've outlined **five simple steps** to help guide you to the right products for your landscape and ensure a successful installation.

Compared to conventional sprinkler systems, drip irrigation systems are simple to design, inexpensive and easy to install. They can also reduce water borne pests and fungal diseases that are spread by water. Unlike traditional high-volume and high-pressure sprinkler systems, which require careful planning, extensive trenching and special tools, drip irrigation systems can be easily installed above or below ground, without special tools or extensive technical knowledge.



Drip irrigation delivers water measured in gallons per hour (GPH), and applies water only where necessary. This yields big rewards by improving plant health, conserving water and reducing weed growth! So, let's start enjoying the many rewards of drip irrigation by using the following steps as a guide.



STEP 2 Determine the Soil Type.

A micro irrigation system is essentially a transportation system which delivers water to a point in or near the plant's root zone. The final link in this transportation system is the soil. The soil's physical and chemical properties determine its ability to transport as well as store water and nutrients.

Soil Matters

The soil is the reservoir for the plants' water and nutrients and the medium through which water and nutrients move. It provides the base in which the plants' roots are anchored. There are various types of soil with different characteristics which determine the proper plantings and the appropriate drippers, micro sprayers or micro sprinklers and flow rates to use. The heavier the soil, for example, the slower the water is absorbed and lower flow rate drip emitters, such as .5 or 1 GPH at a spacing of 18" to 24", should be used. The layout, spacing, dripper selection and flow rates would be different for heavy soil than for sandy soil.



Soil Type

To determine the type of soil in a given area, take a handful of dry soil, grip tightly and release.



- a) **Sandy** (lightly textured) soil will crumble and fall apart
- b) **Loamy** (medium textured) soil will hold together, but then easily breaks apart
- c) **Clay** (heavy) soil will mold without breaking

Tip: For more precise information, consider having a soil test conducted. Many universities offer this service through their extension offices and master gardener programs.

Soil Absorption

Soil type affects water absorption. The right flow makes all the difference.

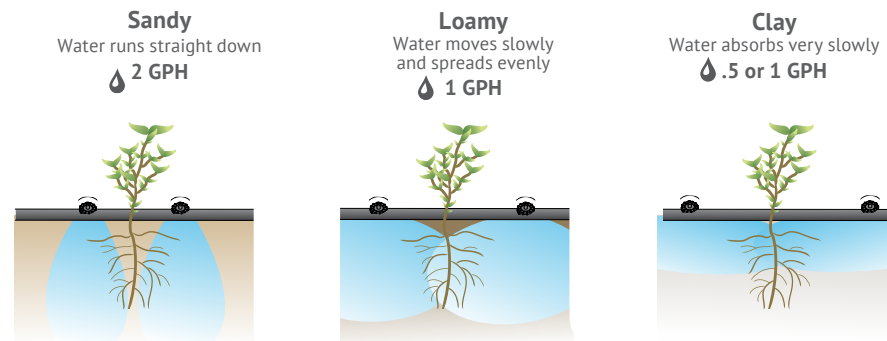

PLANNING



STEP 3 Select the Right Drippers and Spacing.

After reviewing the soil type, select the emission devices (drippers and micro sprayers page 11-18) for your planting, and then calculate the total flow rate of your system.

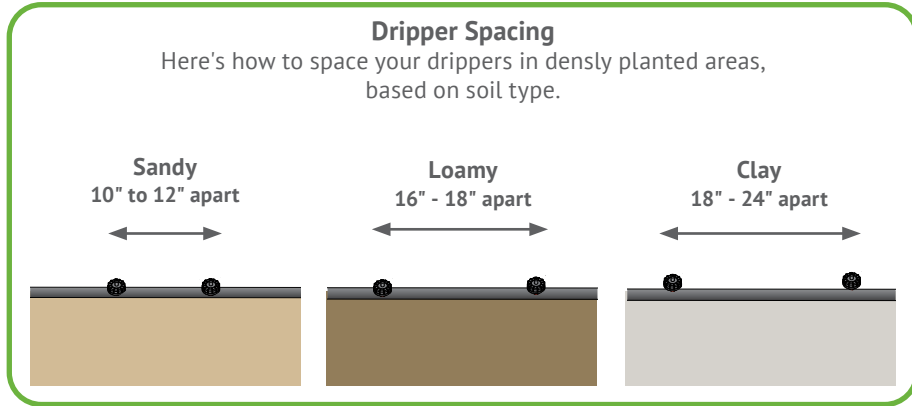

Note: See Chart A on page 33 for detail

Micro Sprinkler Spacing

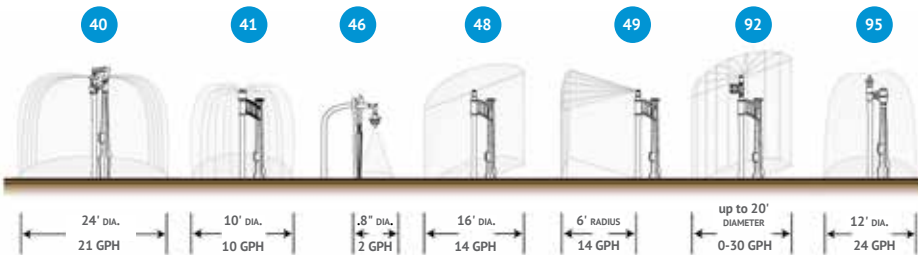

Note: See Chart B on page 33 for detail

STEP 4 Determine How Much Water Is Used.

To determine how much water is used in your system, you need to know the total flow for the installed area, section or zone of the installation. To start, add up the total number of drippers and their flow rates, and then use the same method for micro sprinklers and micro sprayers, if used.



Example: Calculating the total flow rates for this system

You installed a system with 2, 14 GPH micro sprinklers and 40 drippers, consisting of 20, 1 GPH and 20, 2 GPH.

Calculation:

20 - 1 GPH drippers = 20 gallons per hour
20 - 2 GPH drippers = 40 gallons per hour
2 - 14 GPH micro sprinklers = 28 gallons per hour

The total flow rate for your system is 88 gallons per hour (GPH), or if dividing by 60, 1.46 Gallons Per Minute (GPM).

Plan for future planting expansion and plant growth

When plants mature, they may require more water. Watering times can be lengthened to meet those needs, but it is recommended that more drippers should be added to cover the maturing plant roots area. Also, new plants may be added to the landscape, so leave some room in the overall design by having about 20-30% more water capacity available. Using 3/4" faucets and 3/4" anti-siphon valves will almost always provide more than enough water for most home landscapes and garden installation.

TIP: Did you know that the maximum recommended flow rate for a single line of 1/2" poly tubing is 220 GPH (3.6 GPM)? If you exceed this recommended flow rate in your system, add another line of 1/2" poly tubing to your zone or section to double the system size from the same water source.

TIP: Did you know that the recommended flow rate for any section or zone using a 3/4" valve is around 540 GPH (9 GPM)?



STEP 5 Determine Watering Frequency Guidelines

DRIPPER WATERING SCHEDULE

TYPE OF PLANT	LENGTH OF WATERING	WATER EVERY		
		HOT	WARM	COOL
Flower, vegetables	30 min - 1 hr	1 - 2 days	3 days	3 - 4 days
Small trees, shrubs	1 - 2 hours	1 - 2 days	2 - 3 days	3 - 4 days
Vines	3 - 6 hours	1 - 2 days	2 - 3 days	3 - 4 days
Medium trees, shrubs	5 - 7 hours	2 - 3 days	2 - 3 days	4 - 5 days
Large trees, shrubs	6 - 8 hours	1 - 2 days	2 - 3 days	5 - 6 days
Pots to 15"	3 - 5 minutes	1 - 2 days	2 - 3 days	4 - 5 days
Pots over 15"	5 - 10 minutes	1 - 2 days	2 - 3 days	4 - 5 days

MICRO SPRINKLER SCHEDULE

Flowerbeds, groundcover	30 min - 1 hr	1 - 2 days	3 days	3 - 4 days
Small trees	1 - 2 hours	2 - 3 days	4 - 5 days	3 - 4 days
Medium trees	2 - 3 hours	2 - 3 days	4 - 5 days	3 - 4 days
Large trees	2 - 5 hours	2 - 3 days	4 - 5 days	4 - 5 days
Greenhouses, hothouses	5 - 10 minutes	2 - 4 times/day	2 times/2 days	1 time/2 days

CHARTS

Chart A: Dripper Spacing

Determine where to use, number of drippers needed, and spacing (review drippers on pages 11-12)

Plant Type	Number of Drippers and Spacing Per Plant
Flowers	One dripper per plant spaced 10" to 24" apart, depending on soil type
Small shrubs & roses (up to 2')	Two drippers per plant spaced 12" to 18" apart, depending on soil type
Large shrubs & roses (2 to 4')	Two to four drippers per plant spaced 12" to 18" apart, depending on soil type
Vegetables	One dripper, or drip line, spaced 6" to 18" apart, depending on the plant and soil type
Trees	Three to six drippers per plant spaced 12" to 24" apart, depending on soil type
Small Baskets	One dripper per basket



These charts help determine the distance you can run your poly tubing based on which drippers you use, and how far they are spaced out.

Chart B: Micro Sprinkler, Micro Sprayer & Fogger Suggestions

Determine where to use micro sprinklers, micro sprayers or foggers depending on coverage (review on pages 13-16)

Plant Type	Locator Numbers to Use
Flowerbeds	#'s 40, 43, 95, 100 and 101
Ground Cover	#'s 40, 43, 47, 48, 49, 91, 92, 93, 95 or 100
Groups of Plants	#'s 91, 92, 93, 95 and 100
Large Trees	#'s 95, 100 and 101
Germination & Propagations	#'s 43 and 95
Cooling	#'s 65 and 99
Hanging Baskets & Boxes	#'s 65 and 103

Chart C: Dripline, Microline and Soaker Hose Suggestions

Determine where to use dripline (review on pages 17-18)

Plant Type	Number of Drippers and Spacing Per Plant
Shrubs & Roses	12" spacing, 1/4" microline dripline or 18" spacing, PC dripline, depending on plant spacing
Vegetables	6" to 12" spacing, 1/4" microline dripline or 1/4" soaker hose
Narrow Planting	12" spacing, 1/4" microline dripline or 18" spacing, PC dripline, depending on soil type
Trees	Two loops of 18" spacing, PC dripline (1 GPH) or two to three loops of microline with 6" to 12" spacing

Chart D: Maximum Length of 1/2" Poly Tubing with PC Drippers

Dripper Flow Rate & Locator #			Dripper Spacing				
Dripper	Locator #	Flow	1'	2'	3'	4'	5'
PC	30	1 GPH	320'	530'	670'	820'	970'
PC	38	2 GPH	190'	310'	420'	510'	610'
PC	34	4 GPH	120'	200'	250'	320'	450'

Example: If you use PC dripper #30 (1 GPH), you can run 320 ft. of 1/2" poly tubing, spacing the drippers 1' apart.

Chart E: Maximum Length of 1/2" Poly Tubing with Button and Flag Drippers

Dripper Flow Rate & Locator #			Dripper Spacing				
Dripper	Locator #	Flow	1'	2'	3'	4'	5'
Button	31	1 GPH	140'	230'	310'	350'	400'
Button	37	.5 GPH	195'	320'	430'	525'	610'
Button	32	2 GPH	80'	145'	175'	230'	270'
Flag	35	1 GPH	125'	220'	300'	330'	370'

BASIC INSTALLATION STEPS

Outdoor Faucet Connections

Connect the backflow device #10 to the faucet or to a Y hose splitter #1 and attach the filter #13. Next, install a pressure regulator #4, followed by a 3/4" swivel adapter #18 (fig. 1a). If using DIG's Add-It™ Fertilizer Injector, install the injector after the backflow preventer. (fig. 1b). If using a battery powered timer (model BOHE-BT -see fig. 2-, BO9D or BO92A), or solar powered timer (EVO100, fig. 3), install the backflow preventer after the timer. If an RBC 7000 timer (fig. 4) is selected, use the hose fittings included with the timer. All the "hose" type threads should be turned clockwise until "hand tight" only. Tightening with a wrench is not recommended and should not be necessary.

Existing Mainline Connections

DIG battery operated & solar timers and AC valves can also be connected to a PVC mainline. If a PVC mainline is used but it is not accessible, consult with a plumber to advise or to install one for you.

First select which type of control valve to install, AC (electric) or DC (battery/solar). DIG provides battery & solar operated inline valves, anti-siphon valves, or AC valves, all suitable for this type of installation. If the design calls for more than one valve or timer, install the same type for each zone. This may require building a manifold with a series of tees branching off to each valve. Install a manual shut-off valve on the mainline upstream of any valve to simplify maintenance or repairs in the future.

Inline Below-Ground Connections

For installation below ground, use an inline battery operated timer, model RBC 7000 (Fig. 5), or inline 24VAC (electric) valve assembly, model DM075 (fig. 6). Install the controller or the valve assembly inside a

figure 1a



figure 2



figure 3



figure 4

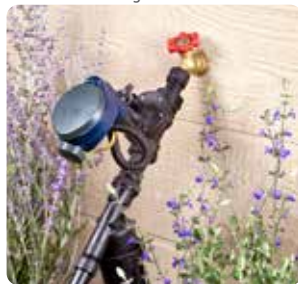

standard rectangular irrigation valve box and complete the head assembly by attaching a Y filter #3 first, then a pressure regulator #5. Use a swivel adapter #16 to connect the poly tubing to the assembly. If PVC pipe is used, use a 3/4" PVC female adapter.

Please note that AC valve installations will involve running underground control wires back to an electric controller.

Above-Ground Connections

Above-ground valve/timer options include model RBC MVA connected into a plastic or brass manual anti-siphon valve, model RBC 8000 (fig. 7), a battery operated timer with an anti-siphon valve, or model ECO1 ASV.075 (fig. 8), a solar powered timer with an anti-siphon valve. Install the anti-siphon valve into a 3/4" riser that is 7"-10" above grade and 6"-8" above the highest dripper, sprayer or sprinkler on the zone. Complete the assembly by connecting a 3/4" Y filter #3, and a pressure regulator #5, or pressure regulating filter #2 to the downstream outlet. Attach a 3/4" swivel adapter #16 (if using poly tubing), or 3/4" PVC female adapter if using PVC pipe.

figure 5



figure 6



figure 7



figure 8



figure 1b



BASIC INSTALLATION STEPS

Fitting Installation with 1/2" Poly Tubing

The most common fittings used to connect the 1/2" (.700" OD) poly tubing are the compression fittings (black) which fit over the outside diameter of the tubing. DIG's compression fittings are color coded by size to fit the different outside diameters (OD) of 1/2" poly tubing. To connect the 1/2" poly, hold the fitting in one hand and the poly tubing in the other and force the end of the poly tubing into the fitting by "walking" or "wiggling" it in until the end is about 1/2" inside the fitting (fig. 9).

To connect various sizes of 1/2" poly tubing with different ODs, use our reducer coupling #15A (fig. 10) for TORO Blue Stripe™ (.710" OD) and #15 for Raindrip™ (.620" OD) or use Universal Nut Lock™ fittings #73, #74, and #75 (fig. 11) to connect any size of 1/2" tubing. To use the Universal Nut Lock™ fittings, remove and insert the nut over the poly tubing. Insert the barb side of the nut lock into the inside of the poly tubing, and insert the other side of the barb into the nut lock housing. Then thread the nut lock onto the housing to secure. In addition, DIG's 17 mm brown barbed fittings can be used with the brown PC dripline and with the poly tubing.

Basic Punch

DIG offers different punches to "punch" the holes in the 1/2" poly tubing for the installation of 1/4" barbs, drippers, micro sprinklers, micro tubing, etc. When installing a small number of drippers, use the basic punch #52 (fig. 12). To use the basic punch, hold the poly tubing in one hand. Hold the punch in the free hand and press the tip into the tubing while twisting the tool creating a hole in the poly tubing.



figure 9



figure 10



figure 11



figure 12

Deluxe Punch

For large number of drippers and for ease of installation, use the deluxe punch #51 (fig. 13) which provides greater leverage and more accuracy. To use the large deluxe punch, first insert the poly tubing into the punch. Then squeeze the handles together to create the hole.

Dripper Installation

Drippers installation methods:

1. Directly into the 1/2" poly tubing
2. At the end of the micro tubing

1. Directly into Poly Tubing

When plants are close to the mainline, install drippers directly into 1/2" poly tubing (fig 14). Punch a hole in the 1/2" poly tubing. Snap the barb side of the dripper into the poly tubing. Make sure that the minimum spacing between the drippers is not less than 10".

2. At End of Micro Tubing

Install the drippers at the ends of the micro tubing to reach plants that are not adjacent to the 1/2" poly tubing or that are in a container. First, attach a barb to one end of the micro tubing. Second, insert the barb into the punched hole in the 1/2" poly tubing. Cut the micro tube to length and insert the dripper into the end of the micro tubing and place it close to the plant (fig 15 & fig 16). Secure the dripper in place with a #57 or #67 micro tubing holder stake.

Drip Tip:

Water during the early morning hours when cooler temperatures and less wind minimize evaporation.

Check the drippers and sprayers frequently and adjust so only the desired area is watered.



figure 13

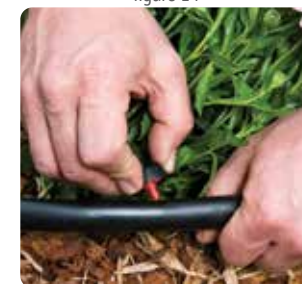

figure 14

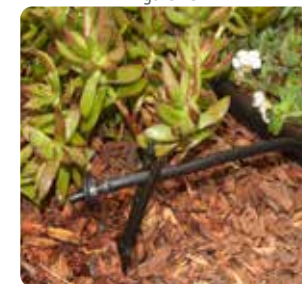

figure 15

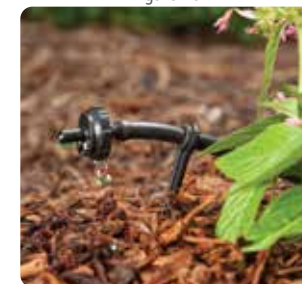

figure 16

BASIC INSTALLATION STEPS

Mini sprinklers and Micro Sprinklers

Mini sprinklers and micro sprinklers are available in 360° patterns and are pre-assembled with a 13" spike, 24" micro tubing and 1/4" barb for maximum flexibility. They offer uniform coverage with a 10' to 25' wetting diameter. To install, simply punch a hole in the 1/2" poly tubing and snap the 1/4" barb into the hole in the poly tubing. The micro sprinklers should be elevated a minimum of 8" above the ground for optimal uniformity and coverage.



Micro Sprayers

Micro sprayers are available with various spray patterns such as 90°, 180° or 360°; for details see page 13-16. They can be used with a PE riser assembly #58, poly riser assembly #58A, universal spike assembly #69 or riser assembly with 1/2" male base #84. To install either one, punch a hole in the 1/2" poly tubing and insert the 1/4" barb or thread at the end of the micro tubing into the poly tubing or use the thread option on PVC pipe. The micro sprayers should be raised a minimum of 4"-8" above the ground for the best uniformity and coverage.



Adjustable Micro Sprayers

Adjustable micro sprayers are available in 90°, 180° and 360° spray patterns with an adjustable flow range of 0-26 GPH with wetting diameter of up to 20'. Consider using them along the perimeter of pathways, on flowerbeds or groundcovers. To install, punch a hole in the 1/2" poly tubing and snap the 1/4" barb of the assembly into the poly tubing.



Foggers & Misters

Foggers and misters emit water in fine droplets with low flow rates (.8-7 GPH). This makes them ideal for slowly saturating the soil in baskets, large pots, or containers so the water is more evenly absorbed. They are available with thread #43, a stake #46, memory-flex tubing #46, and with a barb #99. Fogger #99 is also used on patios and around pools for cooling. To install, first insert a barb into a 1/4" micro tubing. Punch a hole in the poly tubing



and insert the barb. Then, run the micro tubing to the plant, cut it, attach the fogger and secure with a stake. To use the 1/4" micro tubing as the mainline, run the 1/4" micro tubing to the plant and secure it using a 1/4" C-clamp #54. Cut the micro tubing and connect a 1/4" tee #26. Connect another piece of micro tubing to the tee and lay it out into the container. Attach a fogger into the micro tubing and secure it to the pot or basket.

Earthline Brown PC™ Dripline

The Earthline Brown PC dripline is recommended to be installed on the soil's surface and it can be covered with mulch to make it less conspicuous and blend in with the landscape. Earthline Brown PC™ Dripline can be installed in planters, islands or on any landscaped areas. To connect the dripline to the 1/2" poly tubing, use the brown barbed coupling #78, barbed tee #79 or barbed elbow #80, and to close the end of the dripline, use end cap #71 or figure "8" hose end #55. To start the Earthline Brown PC™ dripline from a 1/2" riser, use sprinkler #3 riser-to-drip conversation or conversion elbow #63 with a pressure regulator #4 and swivel adapter #18. Connect the dripline to the swivel adapter and lay the dripline out to water the plants next to the tube. We recommend using dripline in 12" spacing between the lines on sandy soil, 12" to 18" between the lines on loamy soil and 18" to 24" on clay soil for the best coverage.



Microline™ Dripline Installation

The 1/4" dripline is available in 6", 9" and 12" spacing and it is a great choice for use in vegetable gardens or flowerbeds. To install it, DIG recommends using 1/2" poly tubing as the main supply line, running perpendicular to the garden rows. Connect a barb connector #25 into the end of the 1/4" dripline. Punch a hole in the 1/2" poly tubing at the connection point of each row, and insert the open end of the barb connector. After running the 1/4" dripline down the row, use a goof plug #56 to close the end and secure the dripline using a #62 or #62B stake. For vegetable rows more than 2' apart, run one line of micro dripline per row. If the rows are less than 2' apart, place the 1/4" dripline between every two rows. We highly recommend using a 25 PSI pressure regulator with this system.



BASIC INSTALLATION STEPS

Pop-Up Flag Indicator

The Pop-Up Flag Indicator is a simple solution that solves a common criticism of drip irrigation which is not being able to clearly see when the system is running. The flag indicator presents a visual confirmation from a distance that your drip irrigation system is on and operating. The red flag indicator “pops up” and provides a visual signal that the drip system is operating, and it retracts when the system is off.



Retrofit Drip Riser Adapter Installations

The drip riser adapter #90 provides a simple way to connect 1/4" dripline or micro tubing to an existing sprinkler system. This option is perfect for irrigating container plants, groundcover or shrubs that are not covered by the nearby standard spray head. Any plant that needs supplemental irrigation will benefit from this system. The existing spray head or pop-up nozzle can be reconnected to the 1/2" male pipe threads on top of the drip riser adapter without affecting the sprinkler's performance. To install, unscrew the spray nozzle from the top of the riser and momentarily open the system valve to flush the line. Connect the drip riser adapter #90 until hand tight. Reattach the spray head to the top of the drip riser adapter. Lay out the 1/4" micro tubing from the riser to the plant(s) and cut to the desired length. Push the end of the micro tubing onto the outlet barb on the riser adapter. At the end of the micro tubing, install the appropriate emission device.



Initial System Start-Up

Before running your drip system for the first time, it is highly recommended to flush out the lines. To do so, leave all ends of the 1/2" poly tubing open, turn the water on and open the system valve for a minute or two. This will flush out any debris that may be in the system. Close the end of the line by using either the figure "8" hose end



#55 or end cap #71. Check to see that the drippers and micro sprinklers are operating correctly and that there are no leaks. If leakage occurs on the 1/2" poly tubing at the base of a dripper or micro sprinkler, remove that dripper/micro sprinkler, and insert a goof plug #56 to close the hole. Then punch a new hole nearby and reinsert the dripper or micro sprinkler barb into the new hole.

System Maintenance

Inspect the system periodically to ensure that the drippers or micro sprinklers are not clogged, and that there are no breaks or leaks that can decrease pressure. Filter screens should be flushed and cleaned from time to time, depending on water quality. Checking the filter one week after the installation would give you an idea on how often to schedule a filter cleaning. During freezing weather, we recommend draining the poly tubing, or rolling it up and storing it. Remove the end caps and open the hose ends to flush the line once a year. As the landscape matures you may need to add, change, raise or remove drippers or micro sprinklers.



Winterizing Your Irrigation System

Step 1: When freezing weather is anticipated, simply turn off your main water supply to the irrigation system and make sure that the backflow device, valves, filter, pressure regulator, pipe, sprinklers, drip hose, and drippers are free of water.

Step 2: After the main water supply is shut down, run the timer/ controller through its normal watering cycle. This will allow each of the valves to open and relieve water pressure on the main line and valves. Allow the lines to drain slightly. After the timer/controller runs through its cycles, turn the controller off, or to Rain Off position.

Step 3: Through the height of winter leave the system off and drained. Water your plants with hose only. In most cases, there is enough moisture in the ground from rain to sustain the plants during the extreme winter months.



GLOSSARY

Anti-siphon valve

Manual or electric valves with built-in backflow preventer.

Application rate

The volume of water applied to a landscape during a specific time.

Backflow Preventer

A device that prevents the reverse flow of water.

Dripper (Drip Emitter)

A small irrigation device utilized in a drip irrigation system which delivers water at a low flow rate (measured in gallons per hour).

Emission Device

Drippers, micro sprayers, micro sprinklers, foggers, misters, spray sticks and sprayer jets.

Flow control

A valve which modifies flow to maintain a set rate without dramatically altering pressure.

GPH (Flow Rate)

Gallons per hour.

GPM (Flow Rate)

Gallons per minute.

Operating pressure

The pressure at which a system operates.

Polyethylene (PE) tubing

A pipe which is flexible and often used in irrigation systems.

Pressure regulator

An irrigation device which maintains a consistent downstream operating pressure.

PSI

Pressure level measure in pounds per square inch.

Run-off

Water not absorbed during a cycle which flows into another location.

Uniformity

How evenly water is distributed over a given area.

Valve

Similar to a faucet, this device opens and closes to control water flow and often responds to commands from a controller.



QUICK REFERENCE INDEX

TIMERS & CONTROLLERS



Model BO92A

Two dial battery powered hose end timer with 3/4" FHT x MHT



Model B09D & DB

Battery powered hose end timer with 3/4" FHT x MHT



Model BOHE-BT

Bluetooth® Battery powered hose end timer with 3/4" FHT x MHT



Model EVO100

Solar powered waterproof hose end timer with 3/4" FHT x MHT



Model RBC 8000

Battery powered waterproof timer with 3/4" anti-siphon valve



Model ECO1 ASV

Solar powered waterproof timer with 3/4" anti-siphon valve



Model RBC MVA

Battery powered waterproof timer with 3/4" / 1" actuator to automate manual anti-siphon valve



Model RBC 7000

Battery powered waterproof timer with 3/4" inline valve

TUBING & DRIPLINE



Model B12100 (12"), **B18100** (18"), **B18250** (18")
100' and 250'
1/2" dripline | brown



Model B112PC (12"),
100'
1/2" PC dripline | black



Model SHB106 (6"), **SHB109** (9"), **SHB112** (12"),
100'
1/4" dripline | brown



Model SH50 (12"), **SH106** (6"), **SH109** (9"), **SH112** (12")
50' and 100'
1/4" dripline | black



Model ST100R
100' drip soaker tape
12" dripper spacing



Model PSH50
50' Porous Soaker Hose



Model B35, B36, B37, B39
50', 100', 200', 500'
1/2" poly tubing | black
.600" x .700"



Model B38P, B38100P, B38500P
50', 100', 500'
1/4" poly micro tubing | black



Model B38, B38100B
50' and 100'
1/4" vinyl micro tubing | black



Model B38100
100'
1/4" vinyl micro tubing | brown

QUICK REFERENCE INDEX

WATER CONNECTIONS™







Model	Product Description	Locator #	Model	Product Description	Locator #
 D52	Y Hose Splitter 3/4" hose thread	1	 D45	Backflow Preventer 3/4" hose thread	10
 D54	Filter/Pressure Regulator 3/4" pipe thread 155 mesh - 25 PSI	2	 D57A	1-Pint Add-It™ Fertilizer Injector	12
 DSR	Sprinkler Riser to Drip Conversion 1/2" FPT x .700" OD tee	3	 D57A	Swivel Screen Filter 3/4" hose thread 155 - mesh	13
 D46	Pressure Regulator 3/4" hose thread 25 psi	4	 50001	Swivel Compression Adapter 3/4" pipe thread x .700 OD	16
 PR-30-HOSE	Pressure Regulator 3/4" hose thread 30 psi	4A	 C34 & C44	Swivel Compression Adapter 3/4" hose thread	18 18A
 D46P	Pressure Regulator 3/4" pipe thread 25 PSI	5	 C37B	Micro Tubing Compression Adapter 3/4" hose thread x 1/4" micro tubing	21
 H DPR25	25 PSI Heavy Duty Preset Pressure Reg. 3/4" pipe thread	5A	 C38	Swivel Compression Tee 3/4" hose thread x .700" OD	22
 PR-30-PIPE	Pressure Regulator 3/4" pipe thread 30 PSI	5B	 Q59	Conversion Elbow 1/2" pipe thread x 3/4" hose thread	63
 D55	Screen Filter 3/4 in. pipe thread 155 - mesh	6	 AD6	6 Outlet Adjustable Drip Manifold 1/2" pipe thread	86
 50007	Swivel Conversion Adapter 3/4" hose thread x 3/4" pipe thread	7	 A4 & A4-12	4 Outlet Drip Manifold 1/2" pipe thread	87 87A
 PRV075	Adjustable Pressure Regulator 3/4" pipe thread 28-60 PSI	8	 A6	6 Outlet Drip Manifold 1/2" pipe thread	89
 D49	Nipple 3/4" pipe thread x 3/4" hose thread	9	 R67	Drip Riser Adapter 1/2" pipe thread x 1/4" micro tubing	90

FITTINGS™





Model	Product Description	Locator #	Model	Product Description	Locator #
 D50G & D50B	1/2" Compression Reducing Coupling .620" OD to .700" OD .710" OD to .700" OD	15 15A	 C56	1/2" Universal Nut Lock™ Elbow .620"-.710" OD tubing	75
 C33 & C43	1/2" Compression Coupling .700" OD and .710" OD	17 17A	 CB73	1/2" Barbed Connector 1/2" dripline	78
 C35 & C45	1/2" Compression Tee .700" OD and .710" OD	19 19A	 CB75	1/2" Barbed Tee 1/2" dripline	79
 C36 & C46	1/2" Compression Elbow .700" OD and .710" OD	20 20A	 CB76	1/2" Barbed Elbow 1/2"dripline	80
 D48	1/2" PVC to Poly Compression Adapter .700" OD	23	 CB77	1/2" Barbed Adapter 1/2" MPT x 17 mm barb	81
 H84B	1/4" Barbed Elbow	24	 D5010	Self Piercing 1/4" insert connector for 1/2" tubing	82
 H80A	1/4" Barbed Connector	25	 C30	1/2" Compression Adapter 3/4" pipe thread x .700" OD	83
 H82A	1/4" Barbed Tee	26	DRIPPERS™		
 Q58 & Q60	1/2" Compression End Cap .700" OD and .710" OD	71 71A	 PC-CV-6, PC-CV-1	PC Drip Emitter with Built-in Check Valve .58 GPH and 1 GPH	29B 30B
 Q70	1/2" Compression End Cap with Flush Valve .700" OD	72	 B221B, B224B, B222B	Pressure Compensating Dripper 1 GPH, 4 GPH and 2 GPH	30 34 38
 C53	1/2" Universal Nut Lock™ Coupling .620" - .710" OD tubing	73	 W221A, W222A & W2205A	Button Dripper 1 GPH, 2 GPH and .5 GPH	31 32 37
 C55	1/2" Universal Nut Lock™ Tee .620" - .710" OD tubing	74	 FN1A, FN2A & FN4A	Flag Dripper 1 GPH (black), 2 GPH (green), 4 GPH (red)	33 35 36

QUICK REFERENCE INDEX











DRIPPERS™

Model	Product Description	Locator #
 WL0510B, WL110B	In-Line Dripper .5 GPH (red), 1 GPH (black)	31A 37A
 B301, B302	Pressure Compensating Dripper on Spike 1 GPH (black), 2 GPH (green)	30A 38A
 B05B	Adjustable Dripper 0-14 GPH	39
 BA1B	Adjustable Dripper on Spike 0-14 GPH	39A
 BT5B	Adjustable Dripper on 10-32 Thread 0-14 GPH	39E
 AD5	Adjustable Dripper 1/2" Pipe Thread 0-14 GPH	85
 BUS5B	Adjustable Bubbler on Spike 0-28 GPH	102

MICRO SPRAYERS™

Model	Product Description	Locator #
 8855-5GB	Multi-Head Micro Sprinkler on Spike 18 GPH	40
 9950BB	Multi-Head Jet Sprayer on 1/4" threaded barb 10 GPH	41
 7750BB	Fogger Mister 1/4" Threaded Barb 5-7 GPH	43
 7790BB	Pot and Basket Mister with stake 2 GPH	46

MICRO SPRAYERS™

Model	Product Description	Locator #
 7760F	Mister with Memory-flex™ Tubing 1/4" Barb, 2 GPH	46B
 112B, 111B & 110B	Spray Jet Threaded Barb 13 GPH	47 48 49
 112-1B, 111-1B & 110-1B	Spray Jet Assembly on Spike 13 GPH	47A 48A 49A
 107-1B, 108-1B & 109-1B	Fan Spray Jet Assembly on spike 40 GPH, 21 GPH, 8 GPH	47D 48D 49D
 300B & 300-1B	Adjustable Spray Jet 360° on 10-32 thread & on spike, 0-26 GPH	91 91A
 308B & 308-1B	Adjustable Spray Jet 180° on 10-32 thread & on spike, 0-26 GPH	92 92A
 309B & 309-1B	Adjustable Spray Jet 90° on 10-32 thread & on spike, 0-26 GPH	93 93A
 8824-1B	Mini Sprinkler Assembly on Spike 22 GPH	95
 8825BB	Fogger on barb .8 GPH	99
 507-1B	Flow Regulated Micro Sprinkler assembly on spike, 7 GPH	100
 410B	Adjustable Vortex Sprayer on spike, 0-20 GPH	101

ACCESSORIES™

Model	Product Description	Locator #	Model	Product Description	Locator #
 16-035R	Pro Hole Punch	51	 R62B	Heavy Duty Tubing Stake 1/2"	60A
 16-066R	Barb Insertion Tool for 1/4" micro tubing	51A	 R64B	Heavy Duty Tubing Stake 1/2" - brown	60B
 PNC-CUT	Tubing Cutter, Punch and Insertion Tool	51B	 R61B & P32B	Galvanized Tubing Stake 1/2" and 1/4"	61 62
 D44	Hole Punch	52	 P31B	Heavy Duty Micro Tubing Stake 1/4"	62A
 D47B	Tubing "C" Clamp 1/2" - with nail	53	 D32B	Inline Barbed Shut-Off Valve 1/2"	64
 D474B	Micro Tubing "C" Clamp 1/4" - with nail	54	 D33A	1/4" Inline Shut-Off Valve	65
 F68B	Figure "8" Hose End Closure	55	 R66	Ray Spike	66
 G79B	Goof Plugs	56	 P35B	Micro Tubing Stabilizer Stake 1/4"	67
 P33B	Micro Tubing Stake 1/4"	57	 R68	Spike Assembly adjustable flow on 1/4" barb	69
 P34B	Poly Riser 6" with 1/4" barb	58	 DPF1-8	Drip System Flag Indicator extends when system is pressurized	70
 P12B	12" Poly Riser with Self-Piercing Threaded Barb	58A	 R73	8" PE Riser Adapter 1/2" pipe thread	84
 R60	Tubing Stake 1/2"	60			