

Please read instructions carefully before use. Retain for future reference

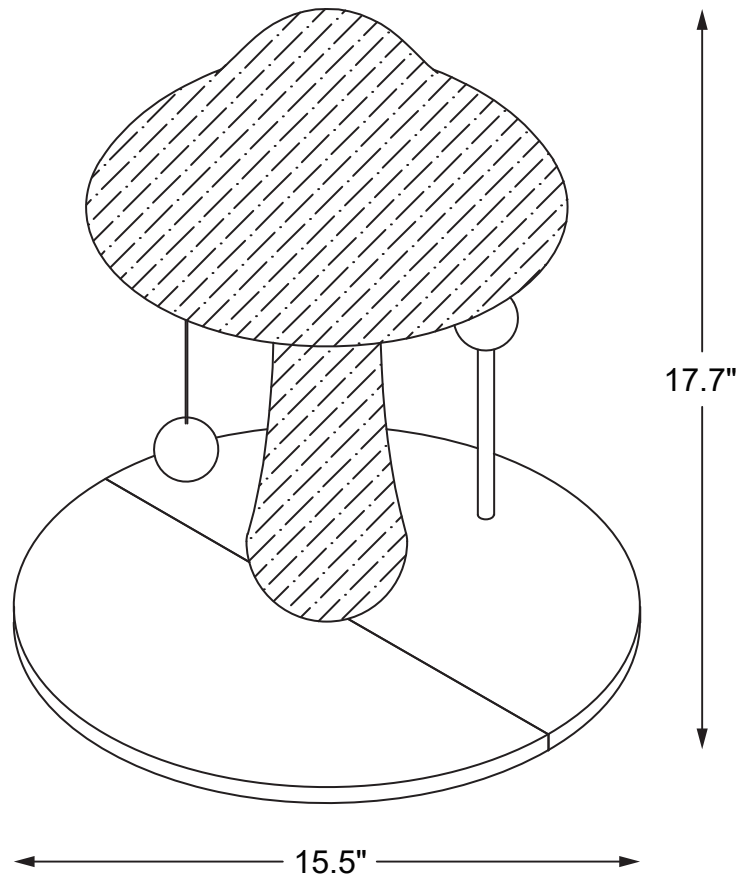

Assembled Dimensions:

15.5 IN.W x 15.5 IN.D x 17.7 IN.H
 39.4 CM W x 39.4 CM D x 45 CM H





Distributed by:
 TRACTOR SUPPLY COMPANY
 5401 VIRGINIA WAY,
 BRENTWOOD TN 37027
 For customer support,
 call: 1-888-376-9601
www.TractorSupply.com
 MADE IN CAMBODIA

Approximate assembly time: 5 Minutes	People for assembly: 	Required assembly space: 39.4in x 39.4in (1m x 1m) 
---	--	--

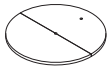
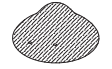

Required assembly tools (included):



PART LIST

Part	Description	Drawing	Qty.
1	Bottom plate		1PC
2	Mushroom top		1PC
3	Post		1PC
4	Spring ball toy		1PC
5	Dangling ball toy		1PC

HARDWARE LIST

Accessory	Size	Quantity
 A	8mm x 35mm	1PC
 B	D10/D30mm	1PC
	5mm	1PC

TIP BEFORE YOU START

- * Ensure that all parts are present prior to assembly.
- * Check all packing material carefully before discarding, as some parts may be encased in the packing material.
- * For ease and speed of assembly, it is recommended that prior to each step all required parts are identified.
- * Ensure that you have sufficient space and people (as indicated on page 1) to assemble product safely.
- * During assembly take care not to over-tighten any fittings, as this may damage the product.

CARE AND MAINTENANCE

- * Always inspect the product during each use for any obstructions.
- * The manufacturer will not accept responsibility for unauthorized repairs or modifications to this product.
- * To prolong the life of your cat furniture we recommend storage in a dry area when not in use or during austere weather conditions.

ASSEMBLY INSTRUCTIONS

Step 1. Connect post 3 to part 1, using screw A and accessory B
Assemble part 4 on part 1

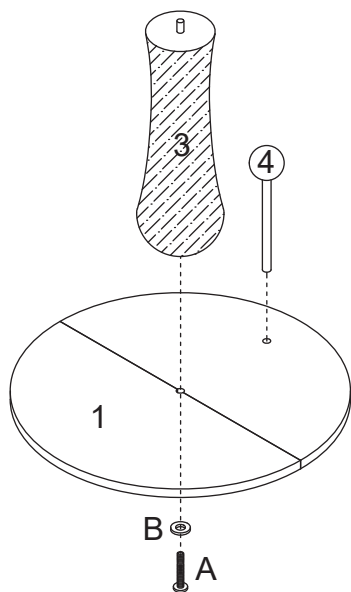

Step 2. Connect part 2 to the post 3
Assemble part 5 on part 2

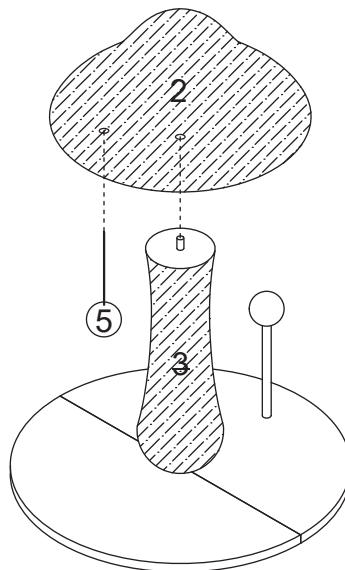

FINISHED ASSEMBLY

