

USER MANUAL

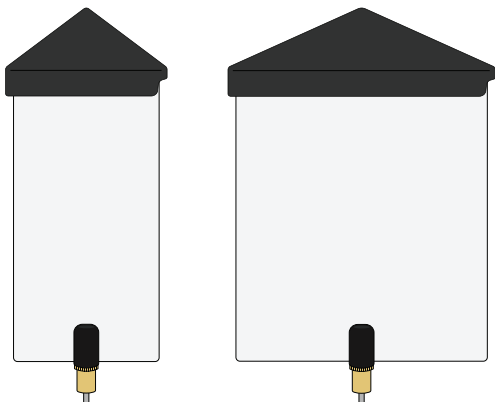

Drinker for Small Animals | 32oz-Capacity 64oz-Capacity



Instructions for Drinking Attachments:



DR-1LTR-MTCP
1L-SMDR-BRAS
WR-1LRD-RABT
2L-SMDR-BRAS
MF-DVIL-8ZA6
DR-2LTR-MTCP
2024.12

RAC PAWS
by RentACoop®

TABLE OF CONTENTS

PACKAGE CONTENTS [32OZ]	4
PACKAGE CONTENTS [64OZ]	5
HOW TO INSTALL THE LID	6
HOW TO USE THE LID	7
HOW TO INSTALL THE METAL AUTO-FILL CUP	8
HOW TO INSTALL THE BRASS VERTICAL NIPPLE	9
HOW TO INSTALL THE BRASS NOZZLE	10
MAINTENANCE	12
CLEANING THE CUP INSERT	12
USING THE EASY-CLEAN PLUG	12-13
HOW TO CLEAN THE METAL AUTO-FILL CUP	14
CONTACT INFORMATION	BACK COVER

IMPORTANT:

When introducing a new type of waterer to your animals, completely remove the previous water source and replace it with the new waterer in the same location.

The position of the drinker depends on the height of your animal. *We do not provide an exact measurement as all animal sizes vary. Please use your best judgement when installing.*



The Vertical Brass Nipple and the Brass Nozzle are perfect for use in freezing temperatures when paired with a heating source/waterer deicer*

**Heating source not included and is sold separately. For safety, please follow the directions that come with your heating source/waterer deicer*

PACKAGE CONTENTS [32OZ]



1x drinker [32oz]



1x lid



1x easy-plug (stored underneath lid)

drinker attachments		
metal auto-fill cup	vertical brass nipple	brass nozzle
<p>1x</p>	<p>1x</p>	<p>1x</p>



1x spring clip

PACKAGE CONTENTS [64OZ]



1x drinker [64oz]



1x lid with easy-plug



1x easy-plug (stored underneath lid)

drinker attachments		
metal auto-fill cup	vertical brass nipple	brass nozzle
<p>1x</p>	<p>1x</p>	<p>1x</p>



1x spring clip

HOW TO INSTALL THE LID

INSTALLATION

1. Place the notches that are located on the inside of the lid into the tracks on sides of the drinker.

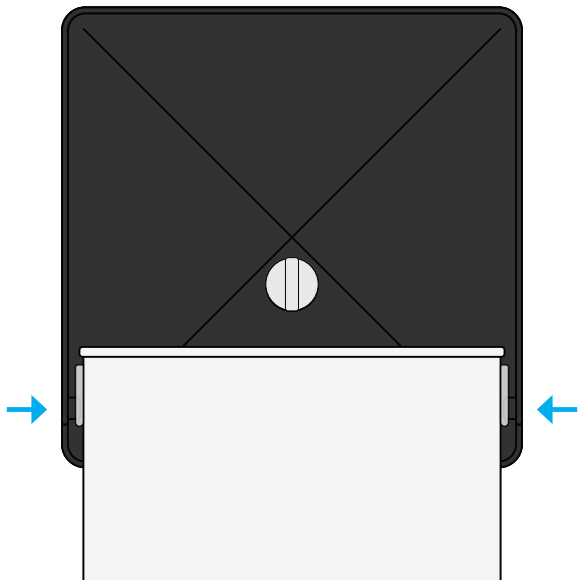

HOW TO USE THE LID

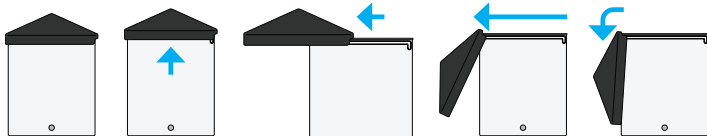
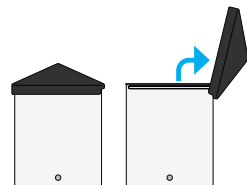
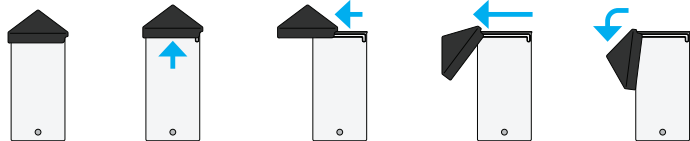
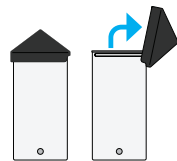

HOW TO INSTALL THE METAL AUTO-FILL CUP



INSTALLATION

1. Hold the drinker on the outside of the cage and screw the cup into the drinker from the inside.
2. Secure the drinker to the cage using the spring clip.

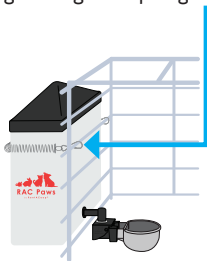
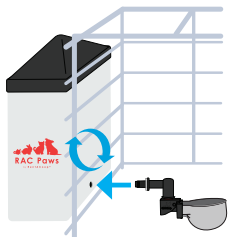

HOW TO INSTALL THE VERTICAL BRASS NIPPLE

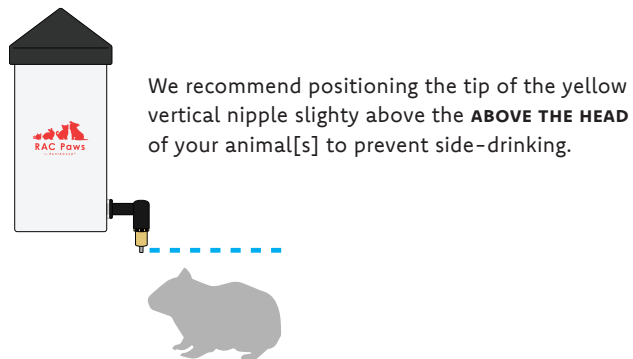

INSTALLATION

1. Screw the vertical nipple into the drinker until tight.
2. Secure the drinker to the cage using the spring clip.

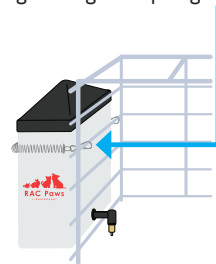
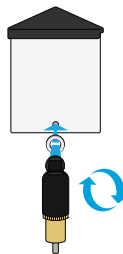

HOW TO INSTALL THE BRASS NOZZLE



The position of the horizontal nipple should be **EYE-LEVEL** with your animal[s].

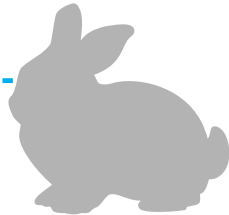

INSTALLATION

1. Screw the horizontal nipple into the drinker until tight using a wrench.

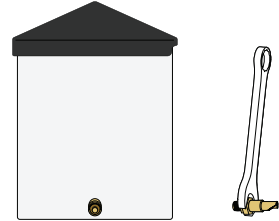

2. Place the drinker on the outside of the cage and secure the drinker using the spring clip.

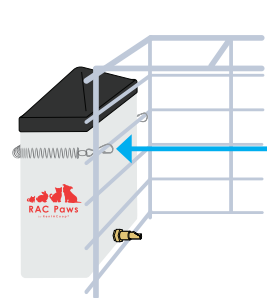

MAINTENANCE

NOTE: To prolong the life of your drinker, we recommend washing the entire drinker at least once a week.

The bottle and lid are dishwasher-safe, top rack only. Disassemble drinker before cleaning.

USING THE EASY-CLEAN PLUG



The small silicone plug that is located underneath the lid can be removed and is used to stop the flow of water so that you can easily unscrew, move, and clean your cup without creating a mess.

ATTENTION! CONTENTS MAY OVERFLOW



Be aware of the **water level** when placing your hand inside the drinker.

1. Remove the **PLUG** from the lid and insert the plug into the hole at the bottom of the inside of the container.

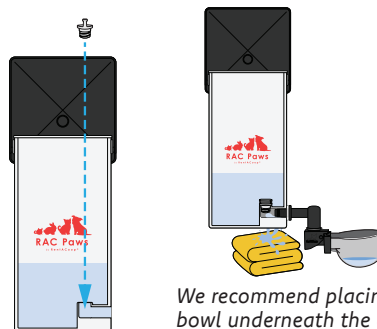

We recommend placing a towel or bowl underneath the attachment.

2. Unscrew the drinking attachment by its elbow.

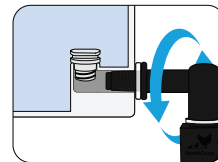

3. After you are done unscrewing, moving, and/or cleaning, re-install the drinking attachment back onto the drinker before removing the plug. Return the plug to the lid to store for safe-keeping.

HOW TO CLEAN THE METAL AUTO-FILL CUP

1. Clean and wipe any dirt or debris from the cup.
2. Pry one side of the tabs on the base to release the small plastic nodule out of its tab. Be careful not to break the nodule off.

There is a load-spring so make sure to take the base off slowly. Once you release the first nodule, the second tab will come off easy.

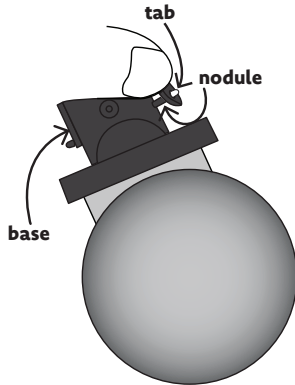

3. Check that all **water spouts** are clean of debris. You can use a toothpick if clogged.

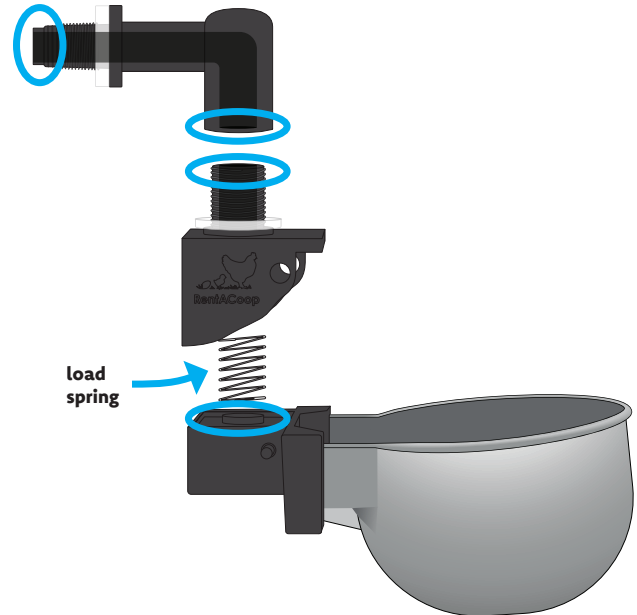



RentACoop®

QUESTIONS?

CONTACT OUR
EGG - SPERTS

info@rentacoop.com

1 800-642-3571

M-F 9-5 EST



@rentacoop
#rentacoop