

PETKIT™

USER MANUAL

PETKIT YUMSHARE SOLO WITH CAMERA
SMART PET FEEDER

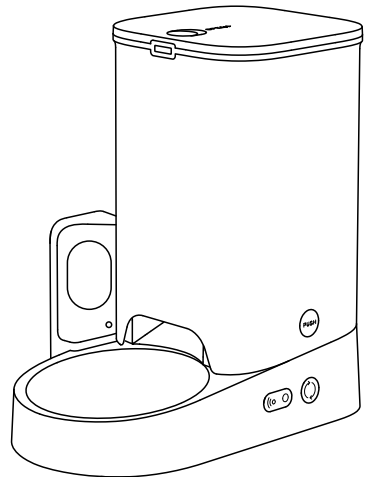

Please read the User Manual carefully before using the product and keep it properly.

TABLE OF CONTENTS

PRODUCT LIST	3
PRODUCT DESCRIPTION	4
PRODUCT INSTALLATION	5,6
HOW TO USE	7,8
CLEANING AND MAINTENANCE	9,10
VIDEO GUIDE	10
BASIC SPECIFICATIONS	11
A MESSAGE TO OUR VALUED CUSTOMERS	12
USER SAFETY GUIDE	12

01 PRODUCT LIST

***Please confirm that the following accessories are complete before installation and use. (Batteries or screwdrivers are not equipped and need to be purchased separately)**

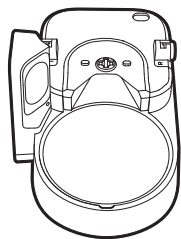

Main Unit

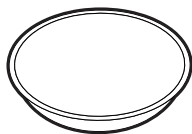

Food Bowl

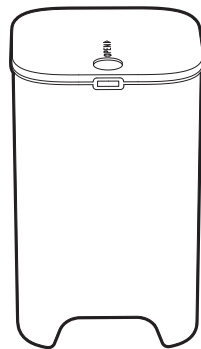

Hopper

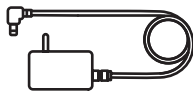

Adapter

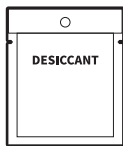

Desiccant



User Manual

*Note: in order to provide a better user experience, we will be implementing periodic product enhancements. Product images shown for illustration purpose only. Actual product may vary from the image shown on the box. For any discrepancies, please refer to the actual product.

02 PRODUCT DESCRIPTION

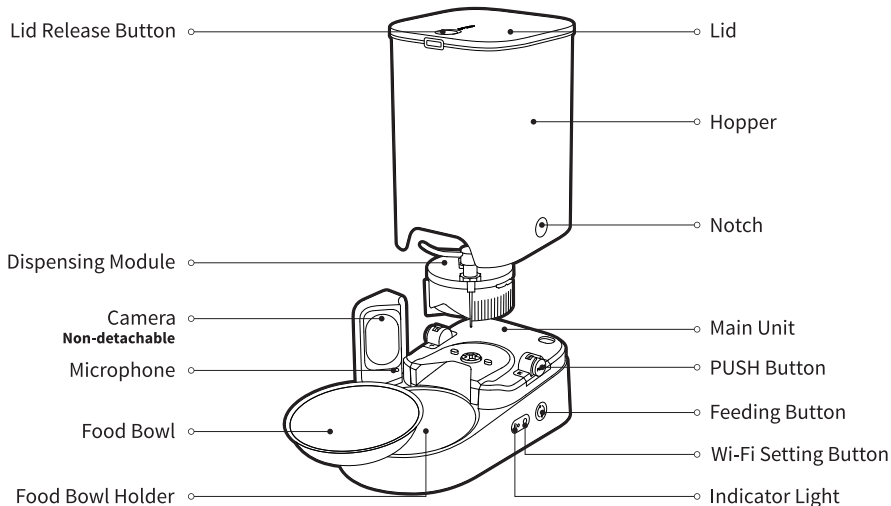

Back of the main unit

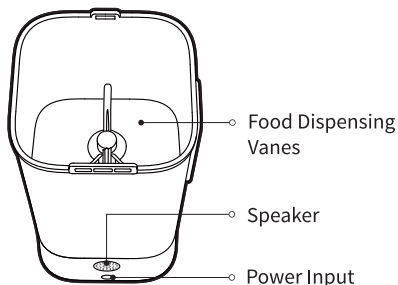

Interior of the lid

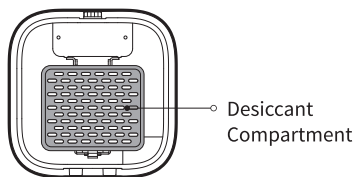

03 PRODUCT INSTALLATION

3.1 Installing the Main Unit

- ① Place the main unit on the level ground or desk.
- ② Lift the hopper, align the notches on both sides with the PUSH button on the main unit, and place it vertically downwards.
- ③ Press and hold the PUSH buttons until they are fully stuck into the notches.
- ④ Place the food bowl in the food bowl holder.

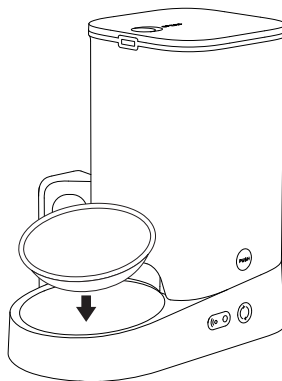
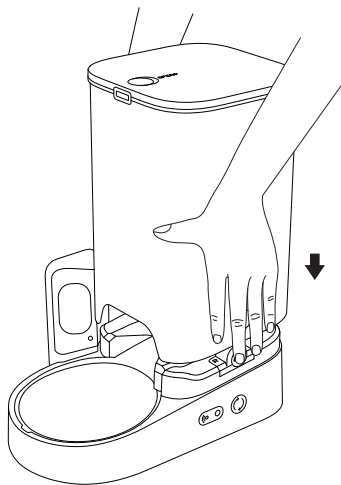

3.2 Connecting the Power Supply

Take out the power adapter cord and attach it to the power input on the back.

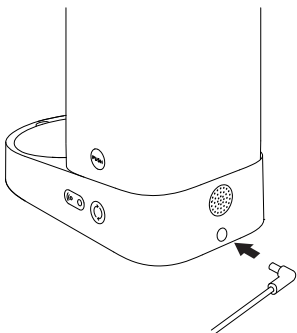

3.4 Installing the Desiccant

① Press the lid release button to the right as shown in the picture, and lift it up to remove the lid.

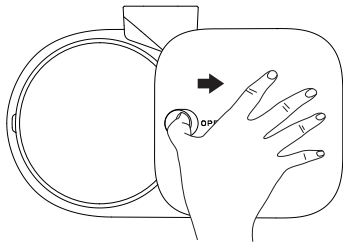

3.3 Installing the Backup Batteries

- ① Take out the screw and remove the battery cover.
- ② Take 5 AAA batteries and place them in the battery compartment. (Pay attention to the orientation of the positive and negative ends)
- ③ Put the battery cover back on and tighten down the screw.

Choose whether to install batteries based on personal actual usage needs. (Batteries need to be purchased separately, and only alkaline batteries can be used)

***Note: When the battery is low, please replace the batteries in time. Check and replace the batteries before leaving the device unattended for an extended period of time.**

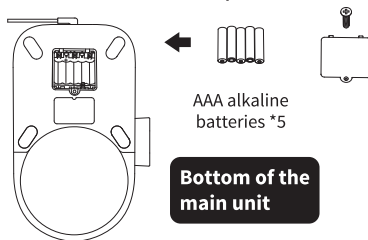

② Open the desiccant compartment, put the desiccant in it, and close the desiccant compartment.

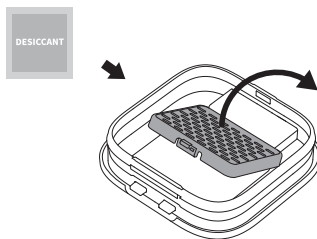

04 HOW TO USE

4.1 Adding Pet Food

① Open the lid to add pet food, and do not exceed the MAX line.

* Recommended kibble size of dry food $\leq 12\text{mm}$ (0.47in)
Recommended kibble size of freeze-dried food $\leq 9\text{mm}$ (0.35in)

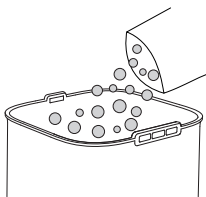

② Cover the lid: Insert the rear side of the lid into the two holes above the hopper.

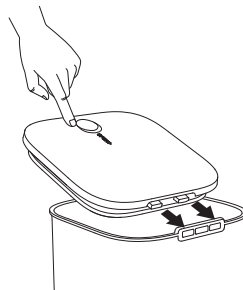

4.2 Indicator Light

The indicator light can be turned on/off in the app.
The indicator light is not on in battery mode.

Indicator light	Status
White light is flashing slowly	Device is not connected to Wi-Fi
White light is flashing quickly	Device is connecting to Wi-Fi
White light is constantly on	Device is connected to Wi-Fi (Camera is not working)
Green light is constantly on	Device is connected to Wi-Fi (Camera is working)

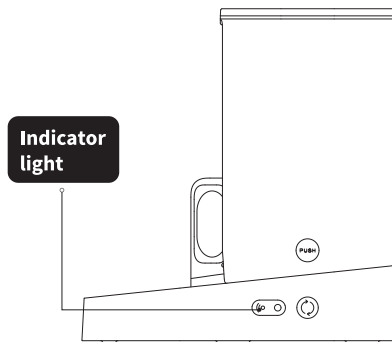

4.3 Manual Feeding

Hold the feeding button to dispense food. Release the button to stop dispensing food.

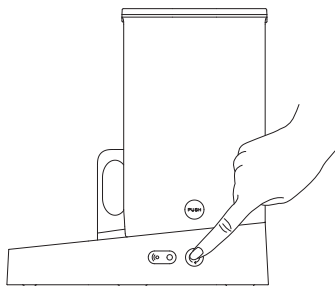

4.4 Smart App Control

App Download and installation: Download PETKIT App from the App Store or Google Play. Enter the homepage, click "+" to add the corresponding device, and bind the device according to the guides.



Scan the QR code to download PETKIT App

- ① Feeding plans can be set in the app, and the feeder will automatically dispense food at set time every day according to the plan. You will receive prompt messages and timely notice the food dispense and feeding status.
- ② The app support real-time viewing of monitor and voice interaction. At the same time, you can also share and review the monitor images. (More exciting features can be experienced in the app)

05 CLEANING AND MAINTENANCE

① Open the lid to remove the desiccant, and then remove the food bowl.

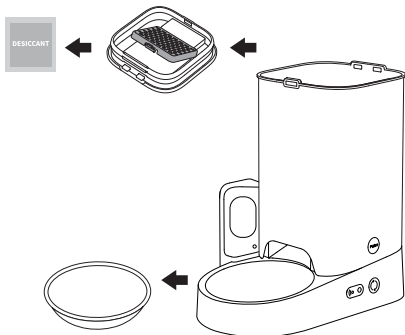

② Hold the PUSH buttons on both sides of the main unit with middle fingers, and lift it up at the same time to remove the hopper.

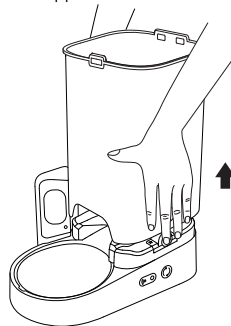

③ Pull out the food dispensing vanes in the hopper. Rotate clockwise to remove the Impeller cover and take out the impeller.

