



ASSEMBLY INSTRUCTIONS

Pour le français, voir la page 2. Para el español, ver la página 3.

8' x 7.5'

STORAGE SHED

MODEL 60396

BEFORE ASSEMBLY:

- Assemble on a level surface
- At least 3 people recommended for assembly



WATCH THE HOW-TO ON YOUTUBE



Scan the code, or visit go.lifetime.com/60396-fullassembly

YouTube® and the YouTube logo are trademarks of Google, LLC.

FOR DOMESTIC USE ONLY! IMPORTANT, RETAIN FOR FUTURE REFERENCE: READ CAREFULLY.

TOOLS REQUIRED

(Not included—unless otherwise indicated*)

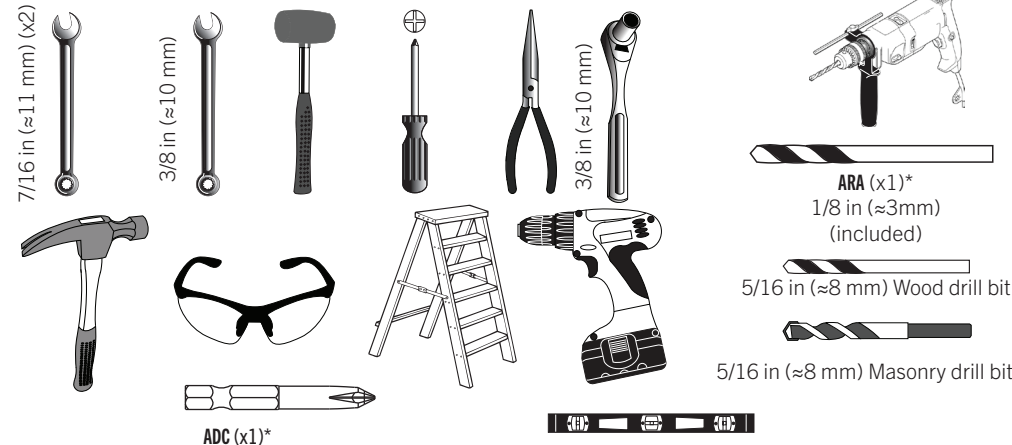

TABLE OF CONTENTS

Icon Legend.....	4
Warnings & Notices.....	5
Platform Construction.....	6
Truss Assembly.....	11
Gable Assembly.....	16
Door Assembly.....	21
Floor Assembly.....	31
Wall Assembly.....	35
Parts Identifier.....	i-iv
Shelving Installation.....	42
Door & Gable Installation.....	47
Roof Assembly.....	51
Door Alignment.....	61
Shed Anchoring.....	63
Cleaning & Care.....	66
Registration.....	67
Warranty.....	69

QUESTIONS?

Dial 1-800-225-3865
(English, French, Spanish)

CONTACT LIFETIME® CUSTOMER SERVICE:

Live Chat: www.lifetime.com/customerservice
(click on "LIVE CHAT" tab)

For Customer Service in mainland Europe:
E-mail: csinternational@lifetime.com

Model Number: 60396
Product ID:



INSTRUCTIONS D'ASSEMBLAGE

For English, see page 1. Para el español, ver la página 3.

ABRI EXTÉRIEUR DE 244 x 229 cm

MODÈLE n° 60396

AVANT L'ASSEMBLAGE :

- Assembler sur une surface de niveau
- Nous recommandons, au moins, 2 adultes pour l'assemblage



REGARDER LA VIDÉO SUR YOUTUBE



Scanner le code, ou visiter go.lifetime.com/60396-fullassembly

YouTube® et le logotype YouTube sont des marques déposées de Google, LLC.

POUR L'USAGE DOMESTIQUE SEULEMENT !

IMPORTANT, CONSERVER POUR RÉFÉRENCE : LIRE AVEC PRUDENCE !

OUTILS REQUIS

(Non inclus — sauf indication contraire*)



SOMMAIRE

Légende des icônes.....	4
Avertissements et avis.....	5
Assemblage de la plate-forme.....	6
Assemblage des fermes.....	11
Assemblage des pignons.....	16
Assemblage des portes.....	21
Assemblage du plancher.....	31
Assemblage des murs.....	35
Identificateur de pièces.....	i-iv
Installation du rayonnage.....	42
Installation des portes.....	47
Assemblage du toit.....	51
Alignement des portes.....	61
L'ancrage de l'abri.....	63
Nettoyage et entretien.....	66
Enregistrement.....	67
Garantie.....	70

QUESTIONS ?

Composer le 1-800-225-3865
(anglais, français, espagnol)

CONTACTER AUX SERVICES À LA CLIENTÈLE LIFETIME® :

Chat en direct: www.lifetime.com/customerservice
(cliquer sur la languette « LIVE CHAT »)

Pour les services à la clientèle du continent européen:
É-mail: csinternational@lifetime.com

N° de modèle : 60396
Référence du produit :



INSTRUCCIONES DE ENSAMBLAJE

For English, see page 1. Pour le français, voir la page 2.

CASETA EXTERIOR DE 244 x 229 cm

MODÈLE n° 60396

ANTES DE ENSAMBLAR:

- Ensamblar sobre una superficie nivelada
- Recomendamos, al menos, 3 adultos para el ensamblaje



MIRAR EL VIDEO EN YOUTUBE



Escanear el código, o visitar go.lifetime.com/60396-fullassembly

YouTube® y el logotipo YouTube son marcas registradas de Google, LLC.

¡SÓLO PARA USO DOMÉSTICO!

¡IMPORTANTE, GUARDAR PARA FUTURA REFERENCIA: LEER CUIDADOSAMENTE!

INSTRUMENTAL REQUERIDO

(No incluido, salvo indicación contraria*)



ÍNDICE

Leyenda de íconos.....	4
Advertencias y avisos.....	5
Ensamblaje de la plataforma.....	6
Ensamblaje de las cerchas.....	11
Ensamblaje de las fachadas.....	16
Ensamblaje de las puertas.....	21
Ensamblaje del piso.....	31
Ensamblaje de los muros.....	35
Identificador de piezas.....	i-iv
Instalación de la estantería.....	42
Instalación de las puertas.....	47
Ensamblaje del tejado.....	51
Alineación de la puertas.....	61
Anclaje de la caseta.....	63
Limpieza y cuidado.....	66
Registro.....	67
Garantía.....	71

¿PREGUNTAS?

Marcar al **1-800-225-3865**
(inglés, francés, español)

PONERSE EN CONTACTO CON LOS SERVICIOS DE CLIENTES LIFETIME®:

Chat en vivo: www.lifetime.com/customerservice Para el servicio a clientes en el continente europeo:
(clicar en la lengüeta «LIVE CHAT») Correo electrónico: csinternational@lifetime.com

Número de modelo: 60396
ID del producto:



ICON LEGEND / LÉGENDE DES ICÔNES / LEYENDA DE ÍCONOS



- Indicates special heed should be taken when reading.
- Indique qu'une attention spéciale doit être portée à la lecture.
- Indica que uno debe prestar atención al leer.



- Indicates the parts (or no parts) required for a section.
- Indique les pièces (ou aucune pièce) à utiliser pour une section.
- Indica las piezas (o ninguna pieza) que se usarán en una sección.



- Indicates the hardware (no new hardware) required for a specific page or section.
- Indique la quincaillerie (ou aucune nouvelle quincaillerie) n'est requis pour une page précise.
- Indica el herraje (que no se necesita nuevo herraje) para una página específica.



- Indicates the tools (or no tools) to be used for a section.
- Indique les outils (ou aucun outil) à utiliser pour une section.
- Indica las herramientas (o ninguna herramienta) que se utilizarán para una sección.



- Indicates to use/not use an electric drill for a specific step.
- Indique quand utiliser une/que ne pas utiliser de perceuse électrique pour une étape précise.
- Indica la utilización de/que no utilizar un taladro eléctrico para un paso específico.



- Indicates the number of adults required to perform a specific step, e.g., 2, 3, 4, etc. **You may be able to do certain steps by yourself but, for safety reasons, it's best to have two or more adults. And...it's always easier with one or two helpers.**
- Indique le nombre d'adultes requis pour effectuer une étape spécifique, p. ex., 2, 3, 4, etc. **Il est possible de réaliser certaines étapes seul mais, pour des raisons de sécurité, il est préférable d'être au moins deux adultes. Et... c'est toujours plus facile avec un assistant ou deux.**
- Indica el número de adultos requeridos para realizar un paso específico, p.ej., 2, 3, 4, etc. **Es posible realizar unos pasos solo mas, por razones de seguridad, es mejor tener dos adultos o más. Y... siempre es más fácil con un ayudante o dos.**



- Indicates to repeat a step or an action.
- Indique de répéter une étape ou une action.
- Indica repetir un paso o una acción.

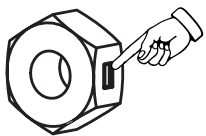

- Indicates the use of a centerlock nut. A nut with this marking will require some effort to tighten. This hardware was designed with this feature in order to prevent loosening later.
- Cette image indique l'usage d'un écrou de blocage central. Un écrou avec ce marquage requerra plus d'effort pour le serrer. Cet écrou a été conçu avec cette fonction afin d'empêcher son desserrage plus tard.
- Indica el uso de una tuerca de bloque central. Una tuerca con esta marca requerirá un poco de esfuerzo para apretarlo. Esta tuerca fue diseñada con esta característica con el fin de evitar su aflojamiento más tarde.



- Indicates a specific step is harder to perform.
- Indique qu'une étape spécifique est plus difficile à exécuter.
- Indica que un paso específico es más difícil de realizar.



- Indicates that one should only hand-tighten the hardware until instructed otherwise.
- Indique qu'il ne faut serrer la quincaillerie qu'à la main jusqu'à ce que l'on reçoive des instructions contraires.
- Indica que sólo se debe apretar a mano el herraje hasta que indique lo contrario.





WARNINGS & NOTICES / AVERTISSEMENTS ET AVIS / ADVERTENCIAS Y AVISOS



English:

- **Failure to follow these warnings may result in serious injury or property damage and will void warranty.**
- To ensure safety, do not attempt to assemble this product without following the instructions carefully.
- Consult all local building codes to verify if the shed requires a building permit.
- Verify the platform foundation is completely level before assembling the shed.
- Be aware that plastic pieces can be damaged by overtightening the screws. To avoid damage, we strongly recommend the use of a drill with a low torque setting. A #2 Phillips screwdriver may also be used.
- Three capable adults are required for assembly.
- All who participate in the assembly process should wear safety glasses throughout the assembly.
- If using a ladder during assembly, use extreme caution.
-  In heavy snowfall areas, we recommend removing snow from the roof. Remove the snow from the roof when the depth of snow equals the length of your hand.
- Do not use or store hot objects near the product.
- Proper and complete assembly are essential to reduce the risk of accident or injury.
- When drilling through metal, beware of burrs, shavings and other sharp edges.
- During and after assembly, do not slide or lift the shed by pushing up on the roof. Move the shed by pushing on the corner panels only.
- Failure to anchor the shed may result in property damage and/or personal injury. The last section, *Shed Anchoring*, in this manual shows the hardware you will need to complete the anchoring. You can find the hardware at your local hardware store.
- **Most injuries are caused by misuse and/or not following instructions. Use caution when using this product.**

Français:

- **Ne pas suivre ces avertissements peut entraîner des blessures graves ou des dommages à la propriété et annuler la garantie.**
- Afin d'assurer la sécurité, ne pas tenter d'assembler ce produit sans suivre attentivement les instructions.
- Consulter tous les codes du bâtiment afin de vérifier si l'abri nécessite un permis de construire.
- Vérifier que la fondation de la plate-forme est complètement à niveau avant l'assemblage de l'abri.
- Ne pas oublier que les pièces de plastique peuvent être endommagées en serrant trop les vis. Afin d'éviter les dommages, nous recommandons fortement l'utilisation d'une perceuse à faible couple. Un tournevis cruciforme n° 2 peut aussi être utilisé.
- Trois adultes en bonne condition physique sont nécessaires pour l'assemblage.
- Tout ceux qui participent au processus de l'assemblage doivent porter des lunettes de sécurité tout au long de l'assemblage.
- Si une échelle est utilisée pour l'assemblage, il faut être extrêmement prudent.
- Dans les zones de fortes tombées de neige, il est recommandé de dégager le toit. Enlever la neige du toit quand la profondeur est égale à la longueur de la main.
- Ne pas utiliser ou entreposer des objets très chauds près de ce produit.
-  Un bon assemblage complet est nécessaire pour réduire le risque d'accident ou de blessure.
-  En perçant le métal, faire attention aux bavures, copeaux et autre bords aiguisés.
- Pendant et après l'assemblage, ne pas faire glisser ou soulever l'abri en poussant le toit vers le haut. Déplacer l'abri en poussant les panneaux muraux angulaires seulement.
- Si vous n'ancrez pas votre abri, des dommages à la propriété et/ou des blessures peuvent en résulter. La dernière section, *Ancrage de l'abri*, de ce manuel indique les matériaux nécessaires pour l'ancrage. Les matériaux se trouvent dans la quincaillerie locale.
- **La majorité des blessures sont causées par une mauvaise utilisation et/ou le non suivi des instructions. Être prudent en utilisant ce produit.**

Español:

- **No seguir estas advertencias puede resultar en lesiones graves o daños a la propiedad y anulará la garantía.**
- A fin de garantizar la seguridad, no intentar ensamblar este producto sin seguir cuidadosamente las instrucciones.
- Consultar todos los códigos de construcción locales para verificar si el cobertizo requiere un permiso de construcción.
- Verificar que el concreto de la plataforma esté nivelado completamente antes de ensamblar el cobertizo.
- Tener en cuenta que las piezas de plástico pueden dañarse si los tornillos se aprietan de más. A fin de evitar daños, lo exhortamos a que use un taladro con función de torque bajo. También puede usarse un desatornillador Phillips no. 2.
- Se necesitan tres adultos para el ensamble.
- Todos los que participan en el proceso de ensamble debe usar anteojos de seguridad durante todo el ensamble.
- Si se usa una escalera durante el ensamblado, es preciso tener cuidado.
- En áreas de nevadas fuertes, recomendamos retirar la nieve del techo. Quitar la nieve del tejado cuando la profundidad de ella es igual a la longitud de la mano.
- No usar ni guardar objetos calientes cerca del producto.
-  El ensamblaje correcto y completo son esenciales para reducir el riesgo de accidente o lesión.
-  Al perforar metal, tenga cuidado las rebabas, virutas y otros bordes afilados.
- Durante y después del ensamblaje, no deslizar ni levantar el cobertizo para empujar en el tejado. Mover el cobertizo para empujar los paneles murales angulares solamente.
- No anclar el cobertizo puede resultar en daños a la propiedad y/o en lesiones personales. La última sección, *Anclaje de el cobertizo*, en este manual muestra el herraje necesaria para terminar el anclaje. Se encuentra el herraje en la ferretería local.
- **La mayoría de las lesiones suceden a causa del mal uso y/o por no seguir las instrucciones. Tener precaución al usar este producto.**

1

PLATFORM CONSTRUCTION / CONSTRUCTION DE LA PLATE-FORME / CONSTRUCCIÓN DE LA PLATAFORMA



• You must provide a platform on which to assemble your shed. Proper building permit documentation may be required in your neighborhood. Consult all local building codes prior to assembling the shed. Before beginning assembly, you must pour or construct a platform. There are two types:

- Concrete
- Wood Frame

Select the type, but know the surface must be leveled and flat before installation. If the surface is not properly leveled and flat, the shed will not assemble correctly. Proper surface leveling will save you time in the long run, so please do not ignore this step. **We recommend a Concrete platform. It will be the most durable and long-lasting choice. The platform you choose must be built above ground in order to avoid water pooling inside the shed. All lumber must be rated for outdoor use!**



• Il faut construire une plate-forme sur laquelle vous devez assembler votre abri. Il est possible que votre quartier exige une documentation visant les permis de construire. Consultez tous les codes du bâtiment locaux, ainsi que les décrets des villes et comtés, pour vérifier que la construction de l'abri extérieur n'exige pas un permis de construire. Avant de commencer l'assemblage, il faut couler ou construire une plate-forme. Il y a deux styles :

- Béton
- Cadre à bois

Sélectionnez le style, mais sachez que la surface d'installation doit être de niveau et plate. Si la surface n'est pas correctement de niveau et plate, l'assemblage de l'abri ne se fera pas correctement. Vous gagnerez du temps sur le long terme grâce à une surface bien de niveau, ne négligez donc pas cette étape. **Nous recommandons une plate-forme en Béton. Ce choix sera le plus durable. La plate-forme que vous choisissez doit être construite au-dessus du sol afin d'éviter l'accumulation d'eau à l'intérieur de l'abri. Tous le bois d'oeuvre doit être approuvé pour l'usage à l'extérieur !**



• Es preciso construir una plataforma sobre la cual usted debe ensamblar su caseta. Puede suceder que en su vecindario se requiera la documentación apropiada de un permiso de construcción. Consulte todos los códigos locales de construcción y los reglamentos de la ciudad y el municipio para asegurarse de que la construcción de la caseta no requiere un permiso de construcción. Antes de comenzar el ensamble, es necesario verter o construir una plataforma. Hay dos clases:

- Concreto
- Armazón de madera

Seleccione la clase, mas sepa que la superficie debe estar nivelada y plana antes de comenzar el ensamble. Si la superficie no está nivelada y plana de manera adecuada, la caseta no podrá ensamblarse correctamente. La nivelación de la superficie le ahorrará tiempo de trabajo, por lo tanto, le pedimos que no ignore este paso. **Recomendamos una plataforma hecho de concreto. Será la elección más perdurable. La plataforma debe ser construida arriba del suelo para evitar el aflujo de agua dentro de la caseta. ¡Toda la madera debe estar clasificada para el uso externo!**

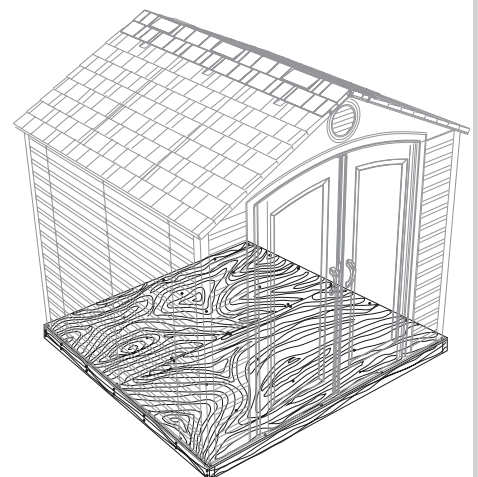
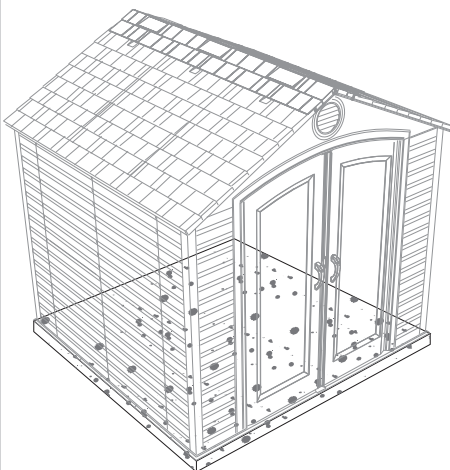

► SECTION 1 (CONTINUED) / SECTION 1 (SUITE) / SECCIÓN 1 (CONTINUACIÓN)

CONCRETE REQUIRED / BÉTON REQUIS / CONCRETO REQUERIDO



1 yd³ (≈0,77 m³)

1.1

CONCRETE PLATFORM / PLATAFORMA DE CONCRETO / PLATE-FORME EN BÉTON

- The concrete should be approximately 4 in (≈10,2 cm) thick. The actual dimensions of the shed, at its widest and longest points, are 96 in x 90 in (≈2,44 m x ≈2,29 m). Ensure you select a site that will accommodate these measurements. **The floor dimensions are a bit smaller than those of the roof; therefore, you will need to build a level surface of 93 1/2 in x 88 in (≈2,38 m x ≈2,24 m).**
- Le béton doit être un épaisseur de 4 in (≈10,2 cm). Les dimensions réelles de votre abri, aux points les plus large et long, sont 96 in x 90 in (≈2,44 m x ≈2,29 m). Assurez-vous de sélectionner un site qui accommodera ces dimensions. **Les dimensions du plancher de votre abri sont plus petites que le toit; ensuite, il faut créer une surface nivelée de 93 1/2 in x 88 in (≈2,38 m x ≈2,24 m).**
- El concreto debe tener, por lo menos, 4 po (≈10,2 cm) de espesor. Las dimensiones reales de la caseta, a sus puntos más ancho y largo, son 96 po x 90 po (≈2,44 m x ≈2,29 m). Asegúrese de seleccionar un sitio que acomodará estas medidas. **Las dimensiones del piso de la caseta son más pequeñas que el tejado; entonces, necesitará crear una superficie nivelada de 93 1/2 in x 88 in (≈2,38 m x ≈2,24 m).**

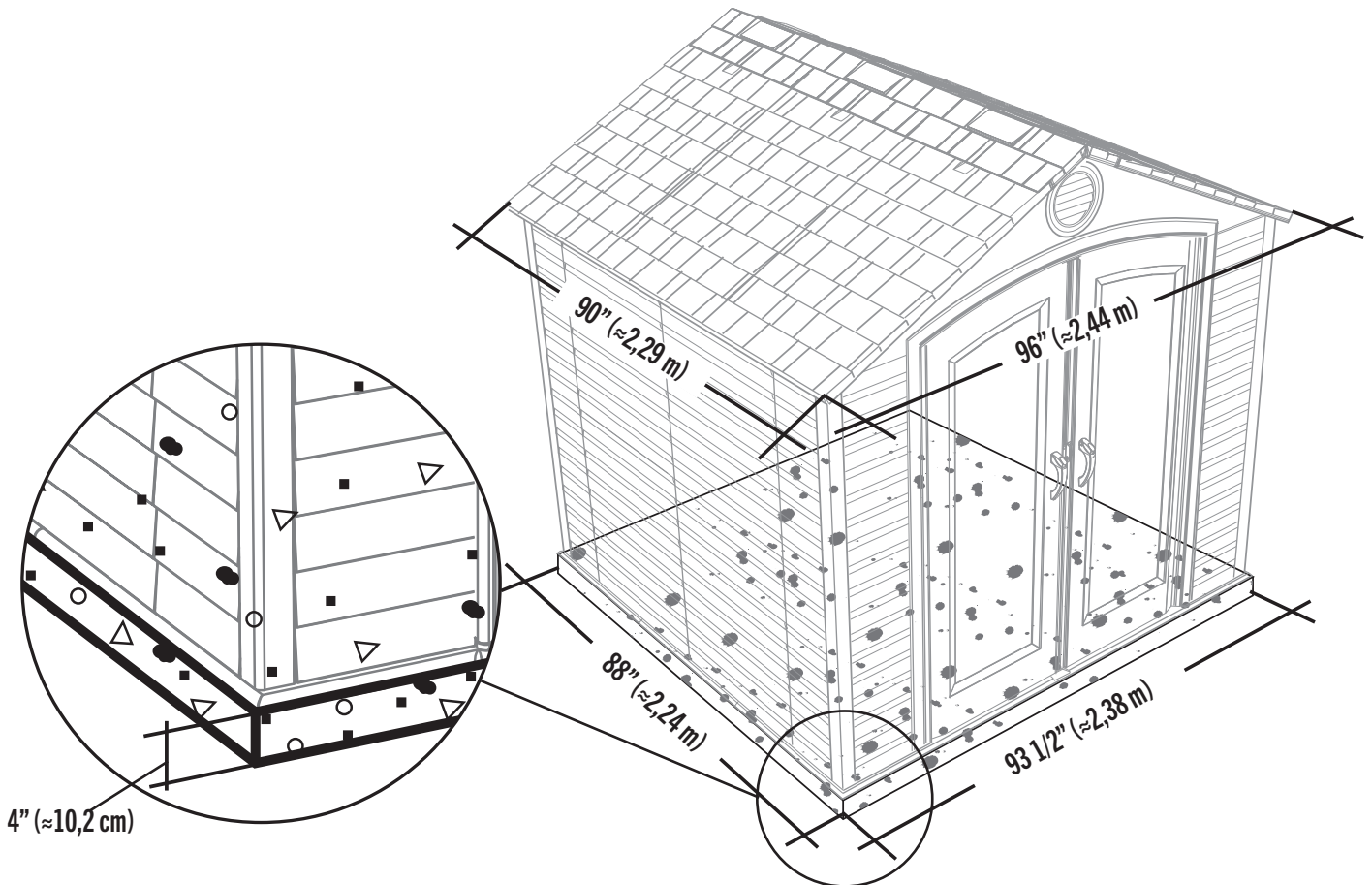

► SECTION 1 (CONTINUED) / SECTION 1 (SUITE) / SECCIÓN 1 (CONTINUACIÓN)

WOOD REQUIRED / MADERA REQUERIDA / BOIS REQUIS



1.2

WOOD PLATFORM / PLATE-FORME EN BOIS / PLATAFORMA DE MADERA

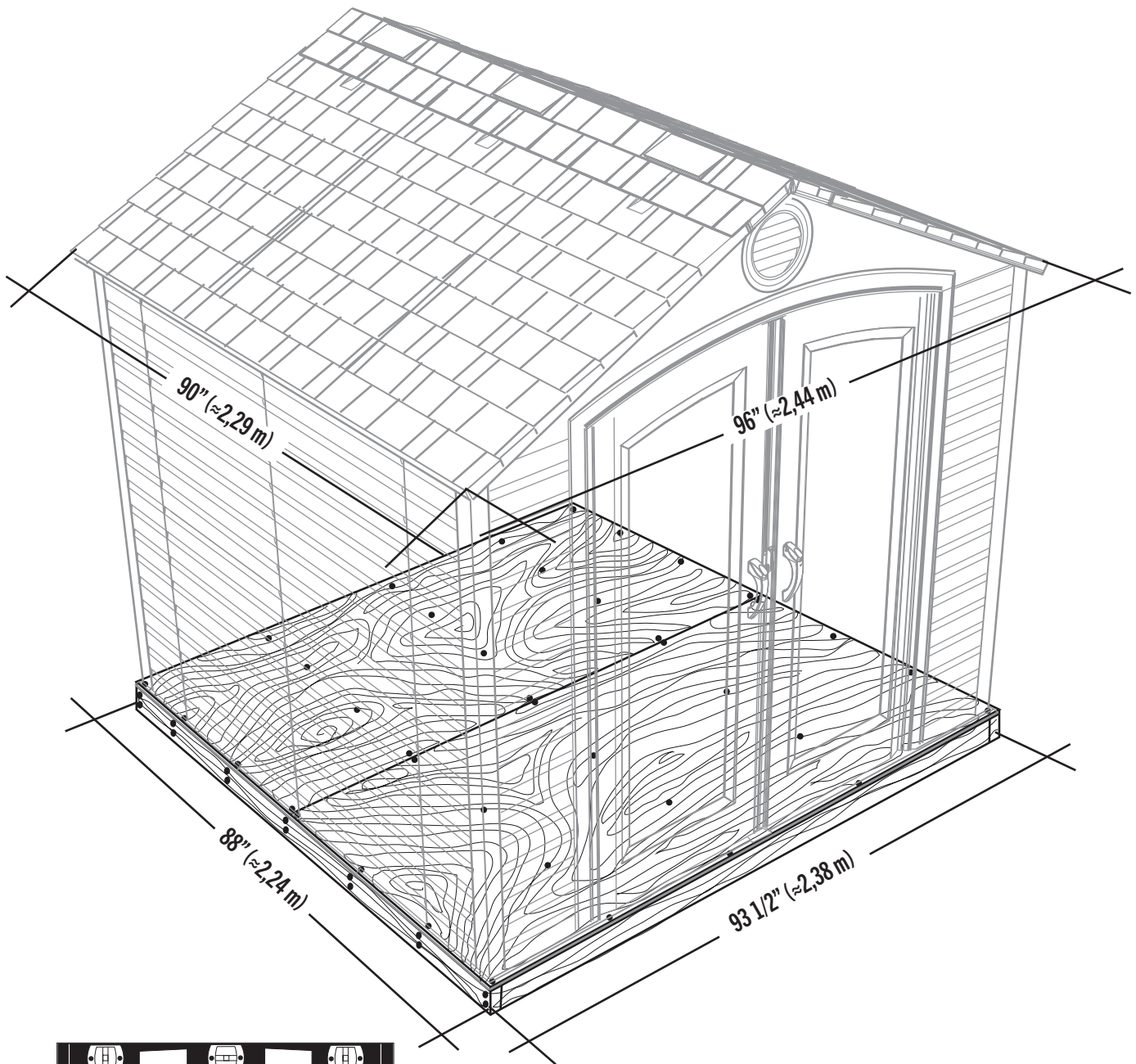

SECTION 1 (CONTINUED) / SECTION 1 (SUITE) / SECCIÓN 1 (CONTINUACIÓN)

TOOLS, PARTS, AND HARDWARE REQUIRED / OUTILS, PIÈCES, ET QUINCAILLERIE REQUIS / INSTRUMENTAL, PIEZAS, Y HERRAJE REQUERIDOS

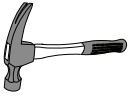

2 in/po x 4 in/po x 88 in/po (≈5,1 cm x ≈10,2 cm x ≈2,24 m) (x2)



2 in/po x 4 in/po x 90 1/2 in/po (≈5,1 cm x ≈10,2 cm x ≈2,30 m) (x7)

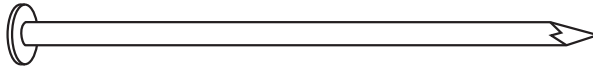

16d 3 1/2 in/po (16d x ≈8,89 cm) (x28)

1.2.1

WOOD PLATFORM / PLATAFORMA DE MADERA / PLATE-FORME EN BOIS

- Ensure all lumber is treated and approved for outdoor use. Build frame to 93 1/2 in x 88 in (≈2,38 m x ≈2,24 m) (outside dimensions). You can also use the plywood as a flat surface when building this frame.
- Vérifiez que votre bois d'œuvre a été traité et approuvé pour l'utilisation à l'extérieur. Construisez un cadre de 93 1/2 in x 88 in (≈2,38 m x ≈2,24 m) (dimensions extérieures). Vous pouvez aussi utiliser le contreplaqué comme une surface plate pendant l'assemblage de ce cadre.
- Asegure que use madera tratada y aprobada para el uso externo. Construya el armazón a 93 1/2 po x 88 po (≈2,38 m x ≈2,24 m) (dimensiones exteriores). Se puede también usar el contrachapado como una superficie plana al ensamblar este armazón.

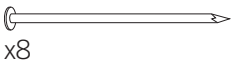

x8

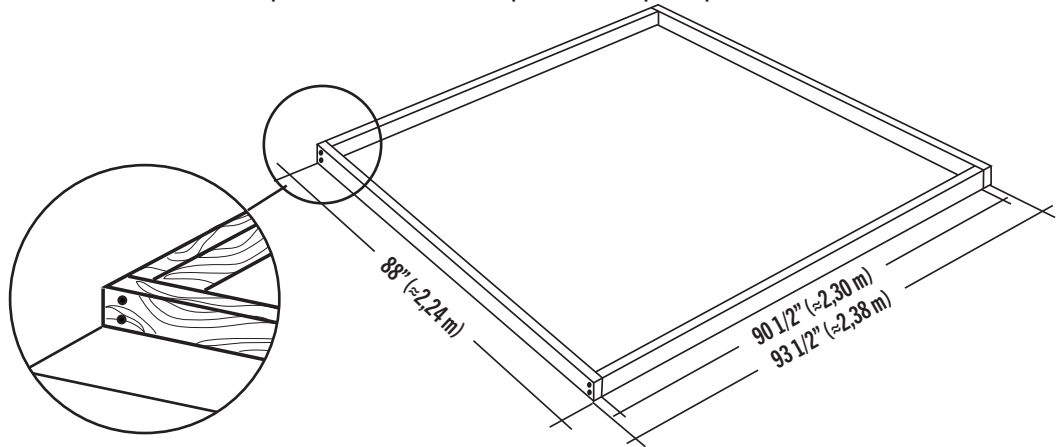

1.2.2

- To ensure studs are in the correct location for nailing plywood in the next step, start measuring from the corner 16 in (≈40,1 cm), and then measure from center to center.
- Pour être sûr d'avoir assez de montant pour clouer le contreplaqué dans le prochaine étape, commencez à mesurer à partir de cette montant 16 in (≈40,1 cm) vers le centre du deuxième montant. Ensuite, mesurez de centre à centre pour les montants restants.
- Para asegurarse que los montantes están en las ubicaciones correctas para el contrachapado en el paso siguiente, comience a medir desde el borde del montante hasta el centro del próximo montante 16 po (≈40,1 cm). Luego, tome la medida de centro a centro en los montantes restantes.

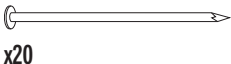

x20

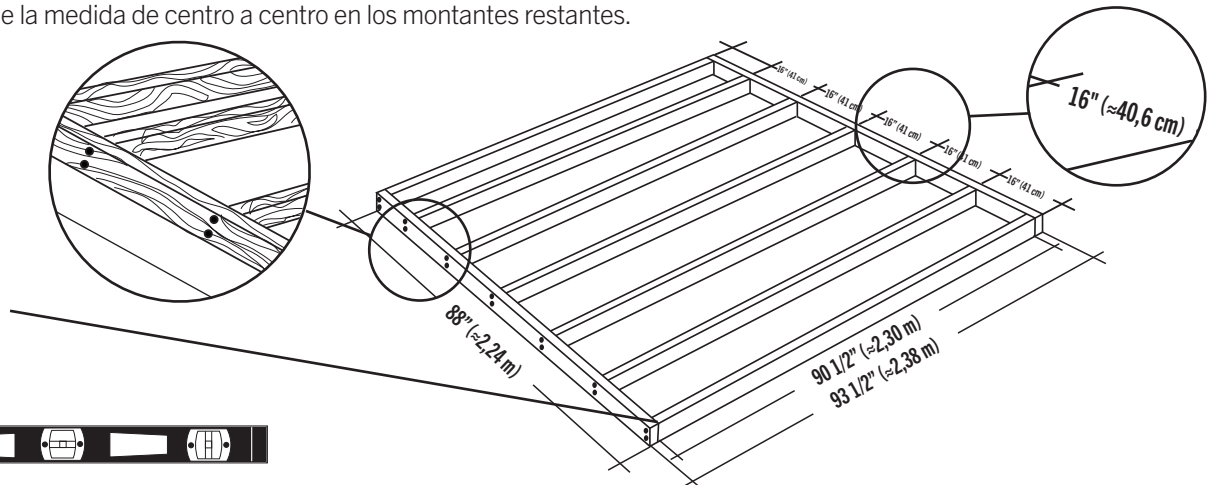

SECTION 1 (CONTINUED) / SECTION 1 (SUITE) / SECCIÓN 1 (CONTINUACIÓN)

TOOLS, PARTS, AND HARDWARE REQUIRED / INSTRUMENTAL, PIÉZAS, Y HERRAJE REQUERIDOS / OUTILS, PIÈCES, ET QUINCAILLERIE REQUIS

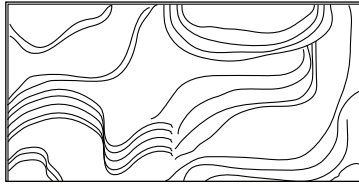
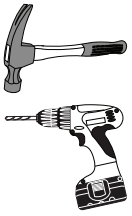

48 in/po x 93 1/2 in/po x 3/4 in/po
(≈1,22 m x ≈2,38 m x ≈19,1 mm) (x1)



40 in/po x 93 1/2 in/po x 3/4 in/po
(≈1,02 m x ≈2,38 m x ≈19,1 mm) (x1)

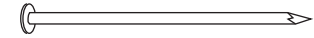

8d 2 1/2 in/po (8d ≈6,35 cm) (x48)

1.2.3

- Square the frame, measuring from corner to corner. **Measurement A & B should be about the same length.**
- Carrez le cadre en mesurant d'angle à angle. **La mesure « A » et « B » doivent être à peu près la même longueur.**
- Cuadrate el armazón midiendo de esquina a esquina. **La medida «A» y «B» deben ser aproximadamente el mismo largo.**

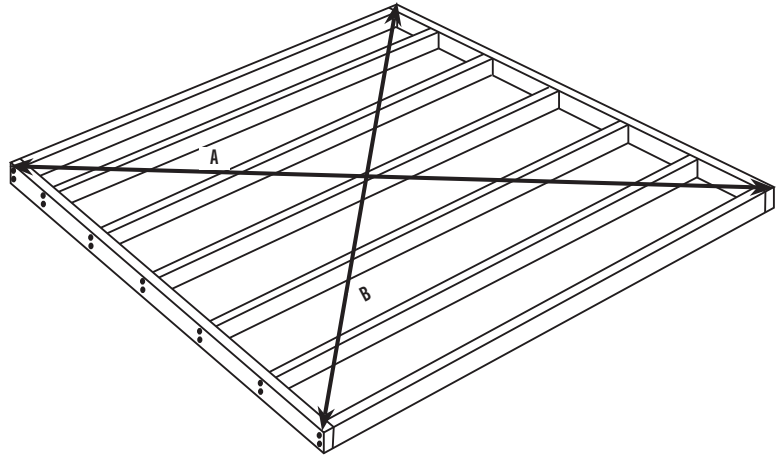

1.2.4

- Using nails, fasten the plywood to the frame. Then, drill 5/16 in (≈7,9mm) holes for drainage.
- En utilisant des clous, attachez bien le contreplaqué au cadre. Ensuite, percez des trous de 5/16 in (≈7,9 mm) pour le drainage.
- Usando unos clavos, sujete el contrachapado al armazón. Entonces, taladre agujeros de 5/16 po (≈7,9 mm) para el drenaje.

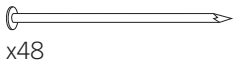

x48

40" x 93 1/2" x 3/4"
(≈1,02 m x ≈2,38 m x ≈19,1 mm)

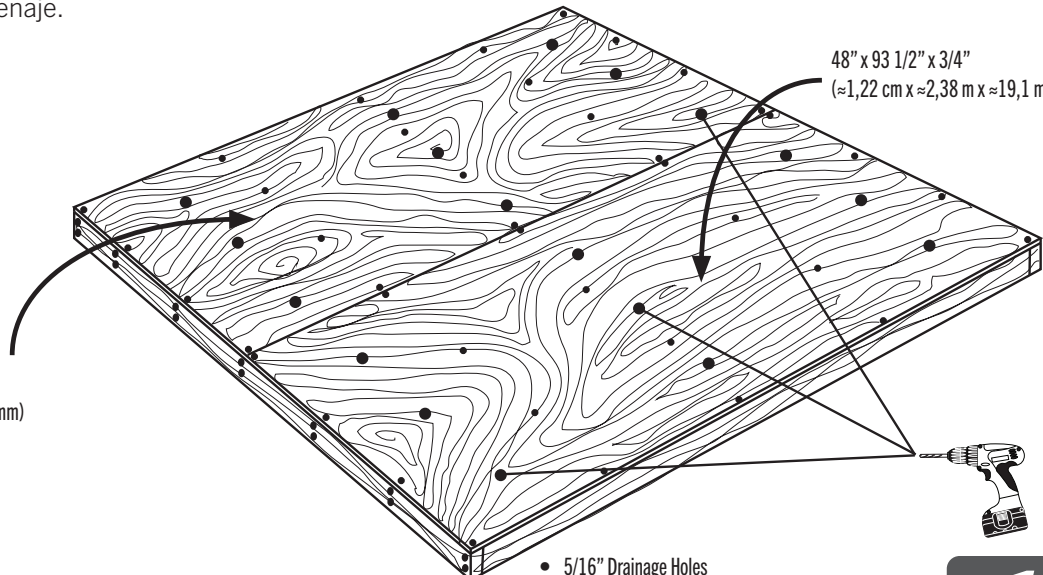

48" x 93 1/2" x 3/4"
(≈1,22 cm x ≈2,38 m x ≈19,1 mm)

- 5/16" Drainage Holes
- Trous de drainage de 7,9 mm
- Agujeros para canalización de 7,9 mm



x18!

2

TRUSS ASSEMBLY / ASSEMBLAGE DES FERMES / ENSAMBLAJE DE LAS CERCHAS



HARDWARE REQUIRED / HERRAJE REQUERIDO / QUINCAILLERIE REQUISE

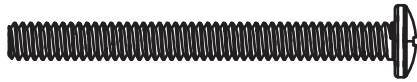

DTK (x8)



ADJ (x4)

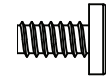

ADY (x8)



ADK (x16)

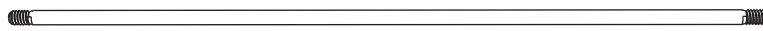

ADH (x2)

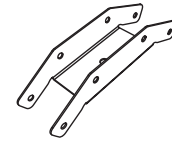

AIP (x2)



PARTS REQUIRED / PIÈCES REQUISES / PIEZAS REQUERIDAS

Metal parts / Pièces en métal / Piezas de metal



DSR (x4)

50 9/16 in/po (≈1,28 m)



AFG (x2)

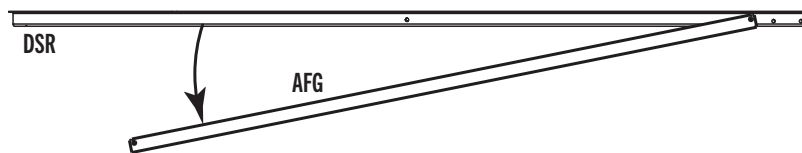
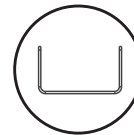

- Sometimes during shipping, the truss brace (AFG) slides over the back of the truss gutter channel (DSR). The two pieces are the same color. If you think you're missing a truss brace, check to see if it is stuck to the back of the truss gutter channel, and separate the two.
- Durant le transport, parfois le support de ferme (AFG) glisse par-dessus l'arrière du canal de ferme (DSR). Les deux pièces sont de même couleur. Si vous pensez que vous n'avez pas de support de ferme, vérifiez s'il y a un support de ferme adhérent à l'arrière du canal de ferme, et séparez les deux.
- Durante el transporte, a veces el soporte de cercha (AFG) deslice sobre el dorso del canalón de cercha (DSR). Las dos piezas son de la misma color. Si piensan que le falta un soporte de cercha, verifique si haya un soporte pegado al dorso del canalón de cercha, y separe las dos.



TOOLS REQUIRED / OUTILS REQUIS / INSTRUMENTAL REQUERIDO

(Not included—unless otherwise indicated*) / (Non inclus — sauf indication contraire*) / (No incluido, salvo indicación contraria*)



7/16 in/po (≈11 mm) (x2)

3/8 in/po (≈10 mm)

► SECTION 2 (CONTINUED) / SECTION 2 (SUITE) / SECCIÓN 2 (CONTINUACIÓN)

TOOLS AND HARDWARE REQUIRED / OUTILS ET QUINCAILLERIE REQUIS / INSTRUMENTAL Y HERRAJE REQUERIDOS



3/8 in/po
(≈10 mm)

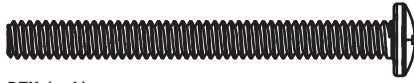

DTK (x4)



ADK (x4)



- In case of any trouble with this section, scan the QR code below to view a video on its assembly.
- En cas de problème avec cette section, scanner le QR code en dessous pour voir une vidéo de l'assemblage.
- En caso de problemas con esta sección, escanear el código QR debajo para ver un video del ensamblaje.



<http://go.lifetime.com/8x7.5-section2>

2.1

- Slide a **connector (AIP)** onto the ends of two **truss gutter channels (DSR)** as shown.
- Glissez un **raccord (AIP)** sur les extrémités des **canaux de gouttière (DSR)** comme illustré.
- Deslice un **connector (AIP)** en los extremos de los **canalones de la cercha (DRS)** como se muestra.

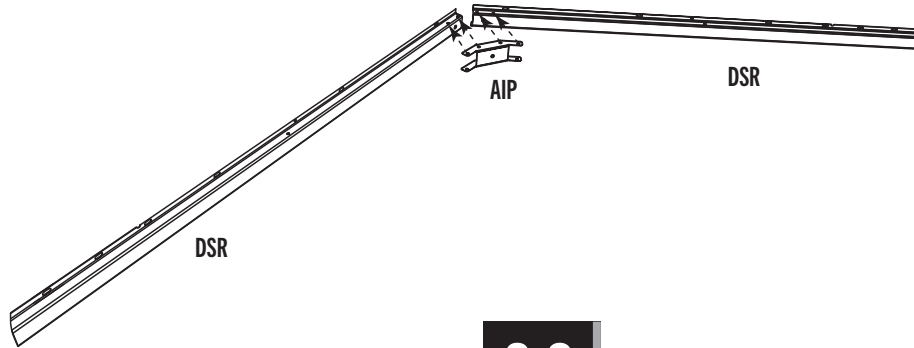

2.2

- Attach the **connector** using the hardware indicated. **Do not overtighten the cap nuts.**
- Attachez le **raccord (AIP)** à l'aide des accessoires indiqués. **Ne pas serrer excessivement les écrous à chape.**
- Sujete el **connector (AIP)** usando el herraje indicado. **No apriete demasiado las tuercas ciegas.**

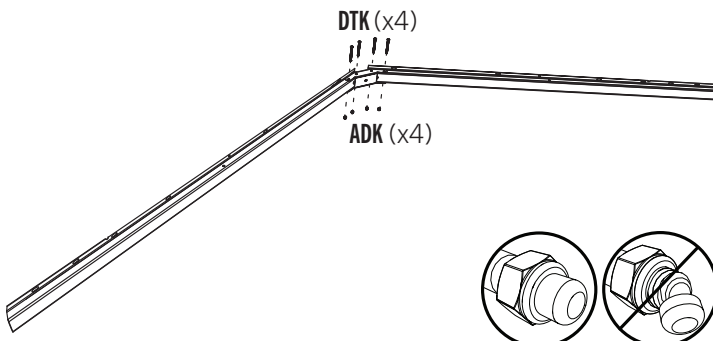

2.3

- Slide a **large truss brace (AFG)** onto the truss gutter channels as shown, and align the holes.
- Glissez un **support grand de la ferme (AFG)** sur les canaux de gouttière comme illustré, et alignez les trous.
- Deslice un **soporte grande de la cercha (AFG)** sobre los canalones de la cercha como se muestra, y alinee los agujeros.

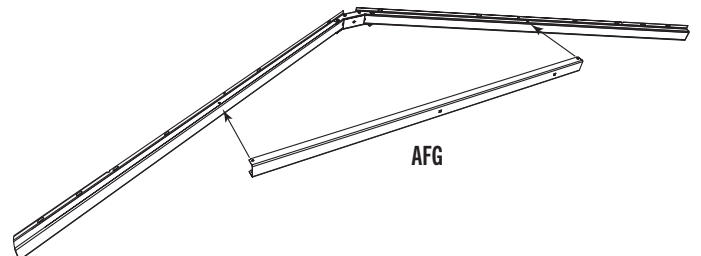

► SECTION 2 (CONTINUED) / SECTION 2 (SUITE) / SECCIÓN 2 (CONTINUACIÓN)

TOOLS AND HARDWARE REQUIRED / OUTILS ET QUINCAILLERIE REQUIS / INSTRUMENTAL Y HERRAJE REQUERIDOS



3/8 in/po
(≈10 mm)

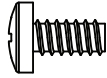

ADY (x4)



ADK (x4)

2.4

- Attach the large truss brace using the hardware included. **Do not overtighten the cap nuts.**
- Attachez le support grand de la ferme à l'aide de la quincaillerie incluse. **Ne pas serrer excessivement les écrous à chape.**
- Sujete el soporte grande de la cercha usando el herraje incluido. **No apriete demasiado las tuercas ciegas.**

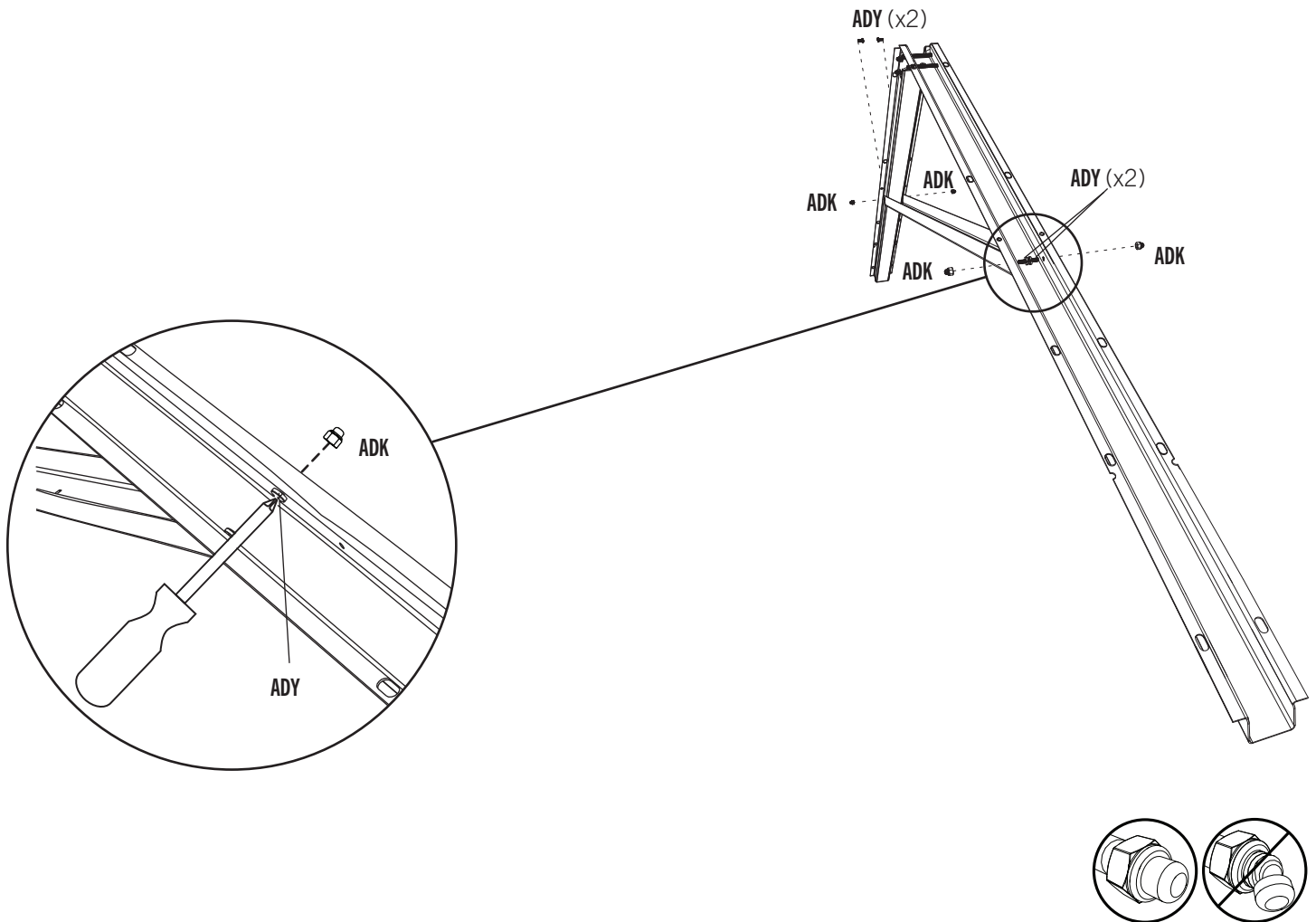

► SECTION 2 (CONTINUED) / SECTION 2 (SUITE) / SECCIÓN 2 (CONTINUACIÓN)

TOOLS AND HARDWARE REQUIRED / OUTILS ET QUINCAILLERIE REQUIS / INSTRUMENTAL Y HERRAJE REQUERIDOS



11 9/16 in/po (≈29,4 cm)

ADH (x1)

2.5

- Slide a **truss rod (ADH)** through the holes in the large truss brace and connector. Secure with two **cap nuts (ADJ)**.
- Glissez une **tige (ADH)** à travers les trous dans le grand support et le raccord. Attachez-la bien à l'aide de deux **écrous à chape (ADJ)**.
- Deslice una **varilla (ADH)** a través de los agujeros en el soporte grande y el conector. Sujétela con dos **tuercas ciegas (ADJ)**.

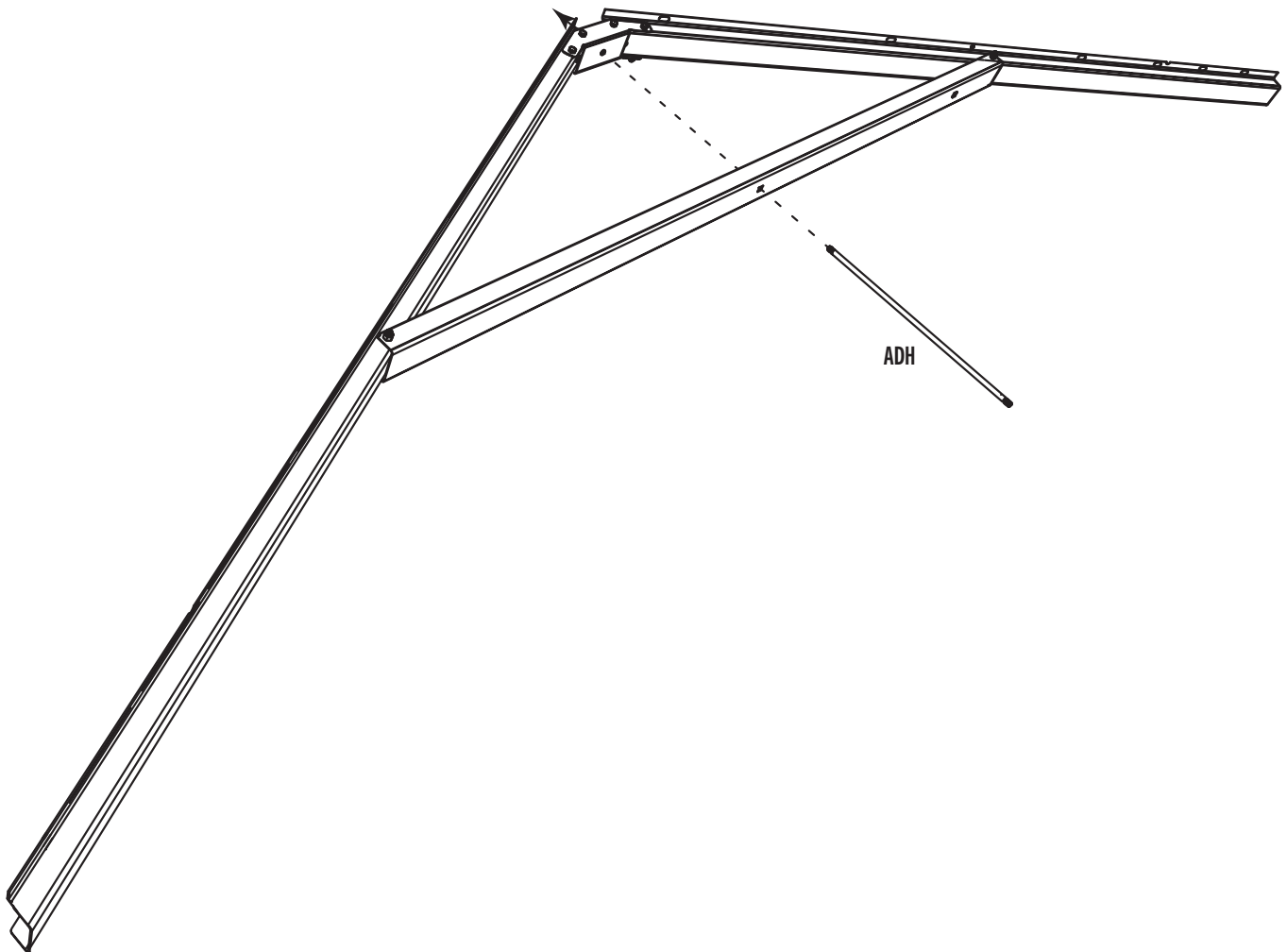

SECTION 2 (CONTINUED) / SECTION 2 (SUITE) / SECCIÓN 2 (CONTINUACIÓN)

TOOLS AND HARDWARE REQUIRED / OUTILS ET QUINCAILLERIE REQUIS / INSTRUMENTAL Y HERRAJE REQUERIDOS



7/16 in/po
(≈11 mm) (x2)

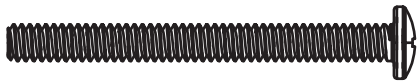

DTK (x4)

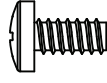

ADY (x4)



ADK (x8)



ADJ (x4)

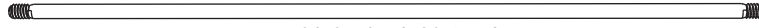

11 9/16 in/po (≈29,4 cm)

ADH (x1)

2.6

- Secure with two cap nuts (ADJ). Do not overtighten the nuts. Repeat this section.
- Attachez-la bien à l'aide de deux écrous à chape (ADJ). Ne pas serrer excessivement les écrous. Répétez cette section.
- Sujétela con dos tuercas ciegas (ADJ). No apriete demasiado las tuercas. Repita esta sección.

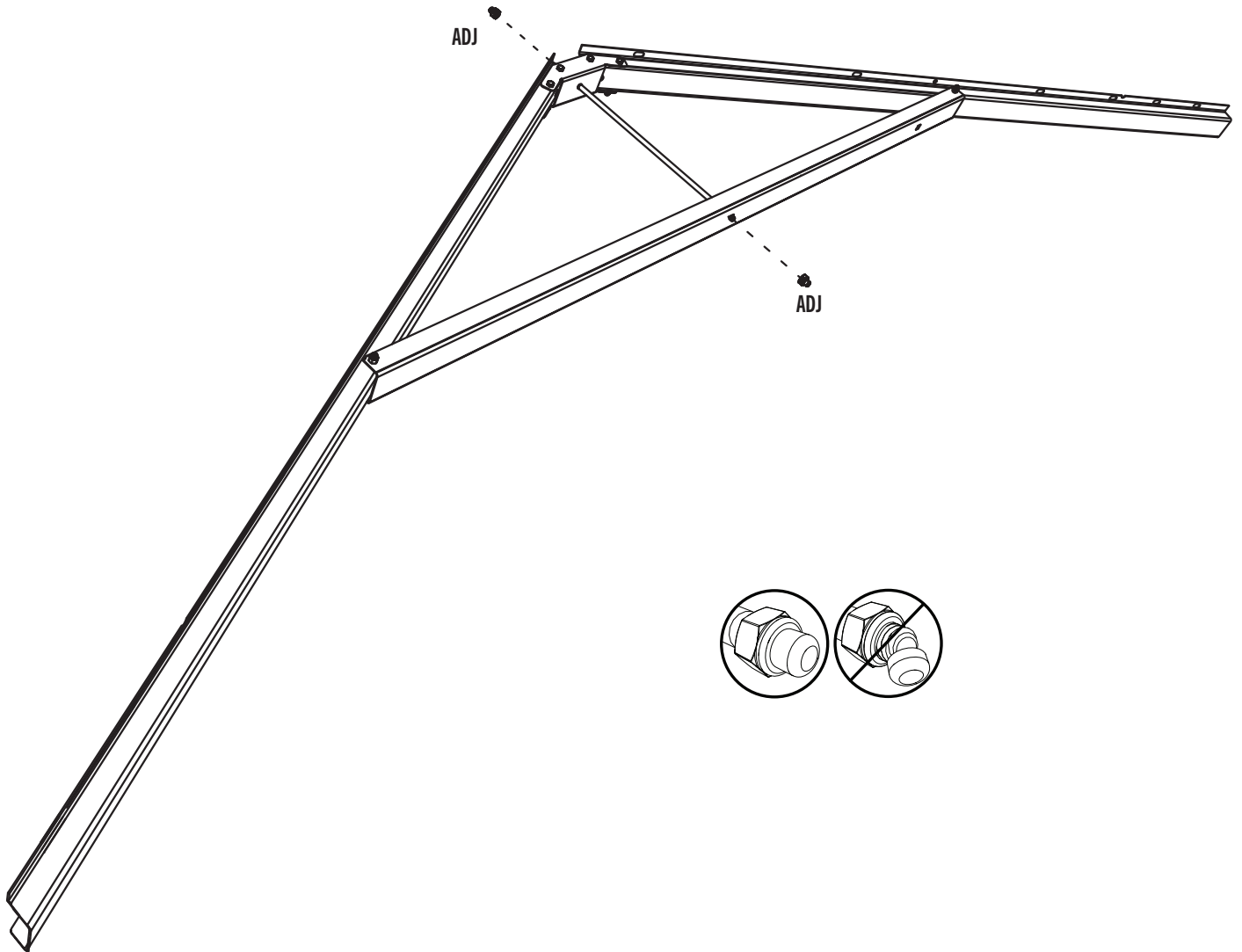

3

GABLE ASSEMBLY / ASSEMBLAGE DES PIGNONS / ENSAMBLAJE DE LAS FACHADAS



HARDWARE REQUIRED / QUINCAILLERIE REQUISE / HERRAJE REQUERIDO

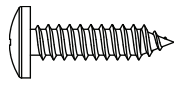

ADW (x10)

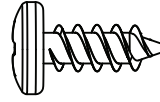

ADZ (x6)



ADK (x2)

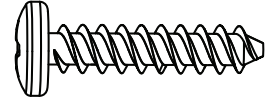

ADV (x6)

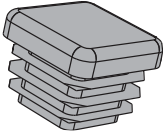

AHS (x2)

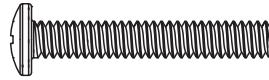

EYR (x2)



CXK (x2)



AEE (x14)



EYQ (x2)

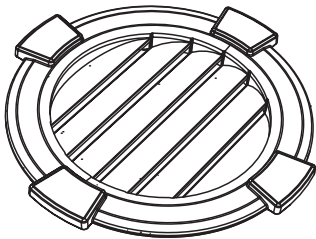

ENH (x2)

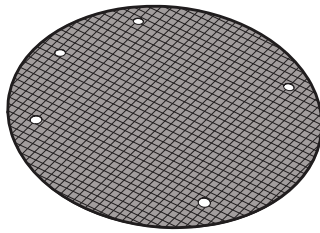

AIQ (x2)



PARTS REQUIRED / PIÈCES REQUISES / PIEZAS REQUERIDAS

Metal part / Pièce en métal / Pieza de metal



EYS (x1)

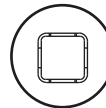

Plastic parts / Pièces en plastique / Piezas de plástico

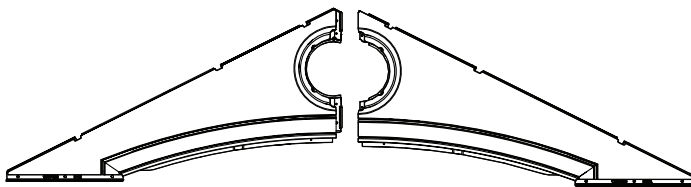

EVZ (x1)

EWA (x1)

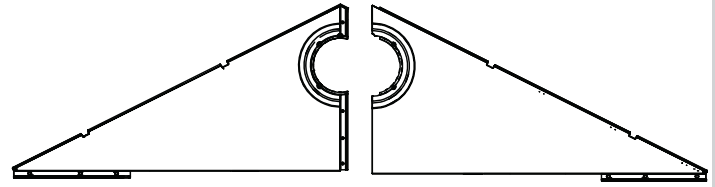

AGI (x1)

AGH (x1)



TOOLS REQUIRED / OUTILS REQUIS / INSTRUMENTAL REQUERIDO

(Not included—unless otherwise indicated*) / (Non inclus — sauf indication contraire*) / (No incluido, salvo indicación contraria*)



3/8 in/po (≈10 mm)

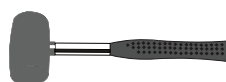

► SECTION 3 (CONTINUED) / SECTION 3 (SUITE) / SECCIÓN 3 (CONTINUACIÓN)

TOOLS AND HARDWARE REQUIRED / OUTILS ET QUINCAILLERIE REQUIS / INSTRUMENTAL Y HERRAJE REQUERIDOS

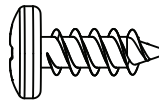

ADZ (x4)



- In case of any trouble with this section, scan the QR code below to view a video on its assembly.
- En cas de problème avec cette section, scanner le QR code en dessous pour voir une vidéo de l'assemblage.
- En caso de problemas con esta sección, escanear el código QR debajo para ver un video del ensamblaje.



<http://go.lifetime.com/8x7.5-section3>

3.1

- Align the holes in the **rear gable halves (AGI & AGH)**.
- Aligner les trous dans les **pignons (AGI & AGH)**.
- Alinear los agujeros en las **fachadas traseras (AGI & AGH)**.

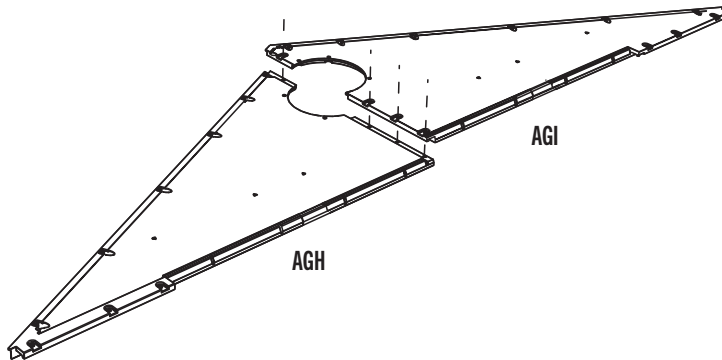

3.2

- Secure the two gable halves with four (4) **screws (ADZ)**.
- Attacher l'un à l'autre à l'aide de quatre (4) **vis (ADZ)**.
- Sujetar el uno al otro usando cuatro (4) **tornillos (ADZ)**.

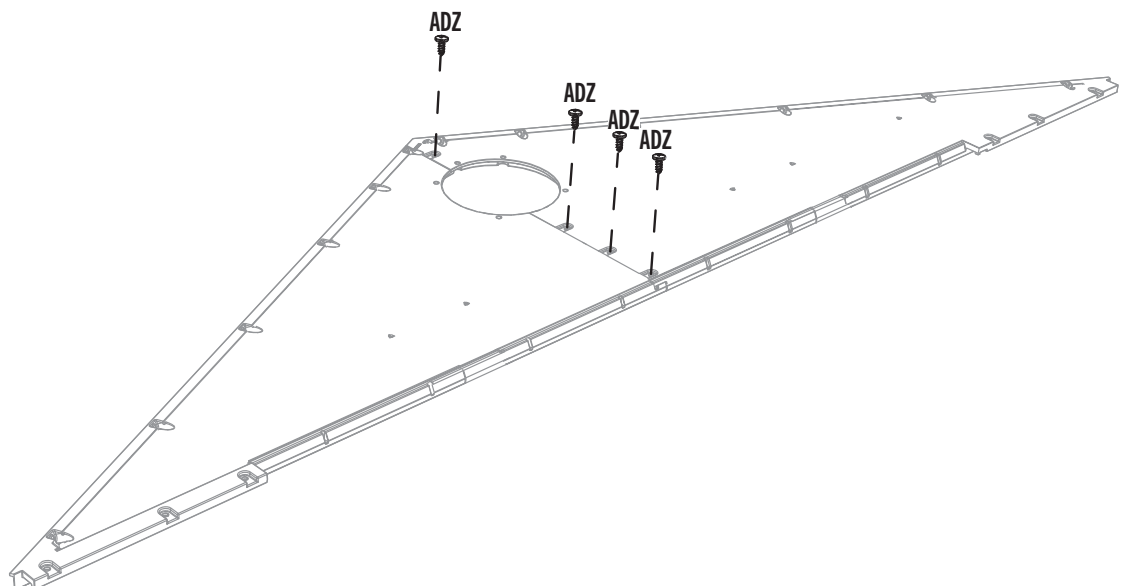

SECTION 3 (CONTINUED) / SECTION 3 (SUITE) / SECCIÓN 3 (CONTINUACIÓN)

TOOLS AND HARDWARE REQUIRED / OUTILS ET QUINCAILLERIE REQUIS / INSTRUMENTAL Y HERRAJE REQUERIDOS



3/8 in/po
(≈10 mm)

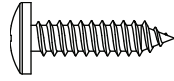

ADW (x5)

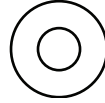

AEE (x5)

3.3

- Place the **screen (AIQ)** over the **vent (ENH)**, and align the five holes in the vent with those in the gable.
- Mettre la **moustiquaire (AIQ)** sur l'**évent (ENH)**, et aligner les cinq trous dans l'évent avec ceux du pignon.
- Colocar el **mosquitero (AIQ)** sobre la **rejilla de ventilación (ENH)**, y alinear los agujeros en la rejilla con los de la fachada.

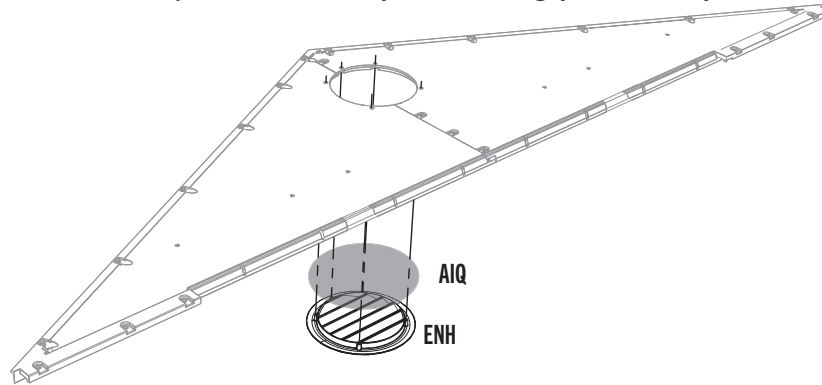

3.4

- Secure with the hardware included.
- Attacher-les en utilisant la quincaillerie incluse.
- Sujetar los unos a los otros usando el herraje incluido.

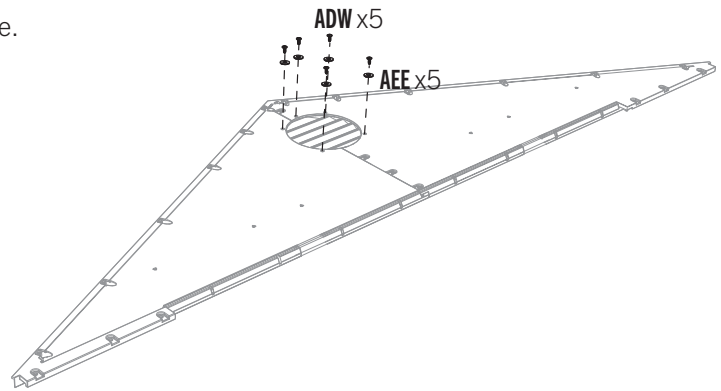

3.5

- Align the holes in the **entry gable halves (EVZ & EWA)**.
- Aligner les trous dans les **demis pignons d'entrée (EVZ & EWA)**.
- Alinear los agujeros en las **mitades de la fachada trasera (EVZ & EWA)**.

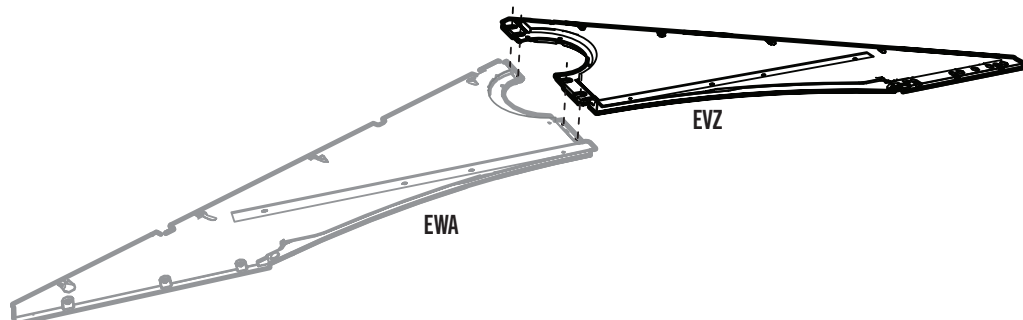

SECTION 3 (CONTINUED) / SECTION 3 (SUITE) / SECCIÓN 3 (CONTINUACIÓN)

TOOLS AND HARDWARE REQUIRED / OUTILS ET QUINCAILLERIE REQUIS / INSTRUMENTAL Y HERRAJE REQUERIDOS

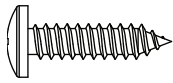

ADW (x5)

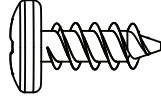

ADZ (x2)

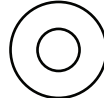

AEE (x7)

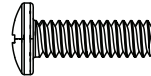

EYQ (x2)



CXK (x2)

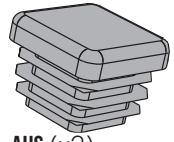

AHS (x2)

3.6

- Secure with the hardware included. **Do not overtighten.**
- Fixer à l'aide de la quincaillerie incluse. **Ne pas trop serrer.**
- Sujetar con el herraje incluido. **No apretar demasiado.**

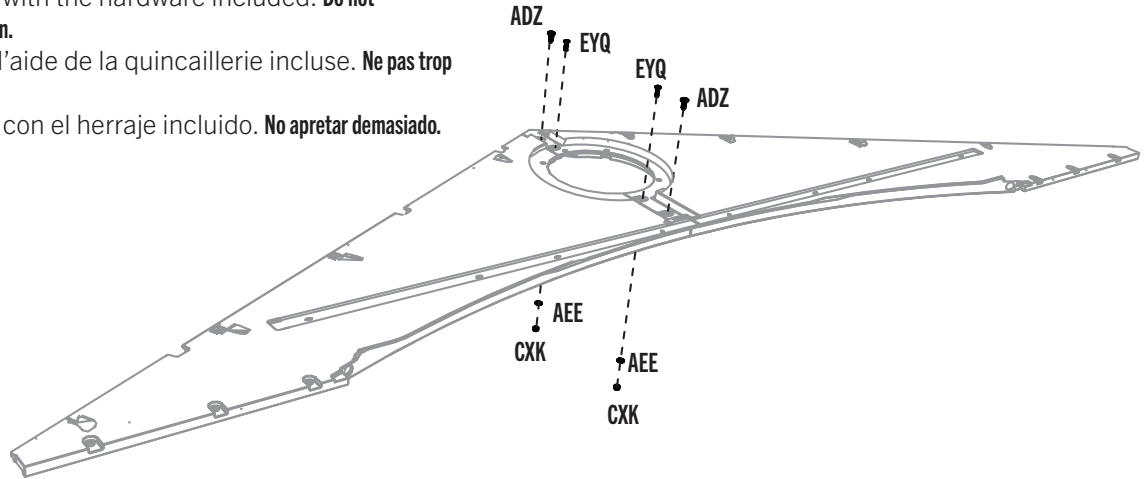

3.7

- Repeat steps 3.3–3.4 for the entry gable.
- Répéter les étapes 3.3 – 3.4 pour le pignon d'entrée.
- Repetir los pasos 3.3–3.4 para la fachada de entrada.

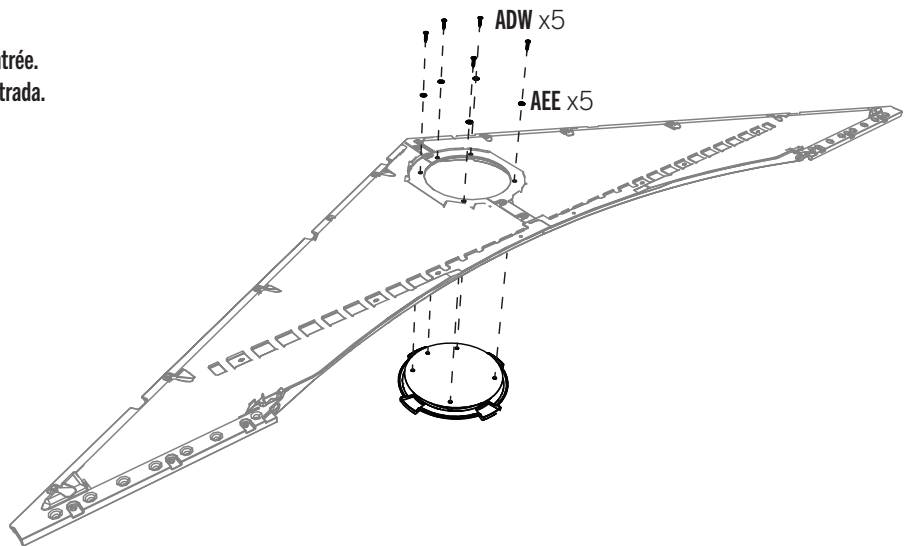
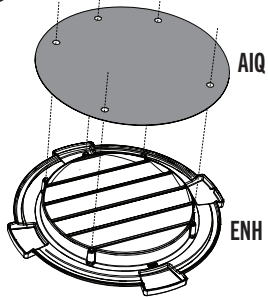

3.8

- Insert an **end cap (AHS)** into each end of the **header (EYS)**.
- Insérer un **capuchon (AHS)** dans chaque extrémité du **linteau (EYS)**.
- Insertar un **tapón (AHS)** en cada extremo del **dintel (EYS)**.

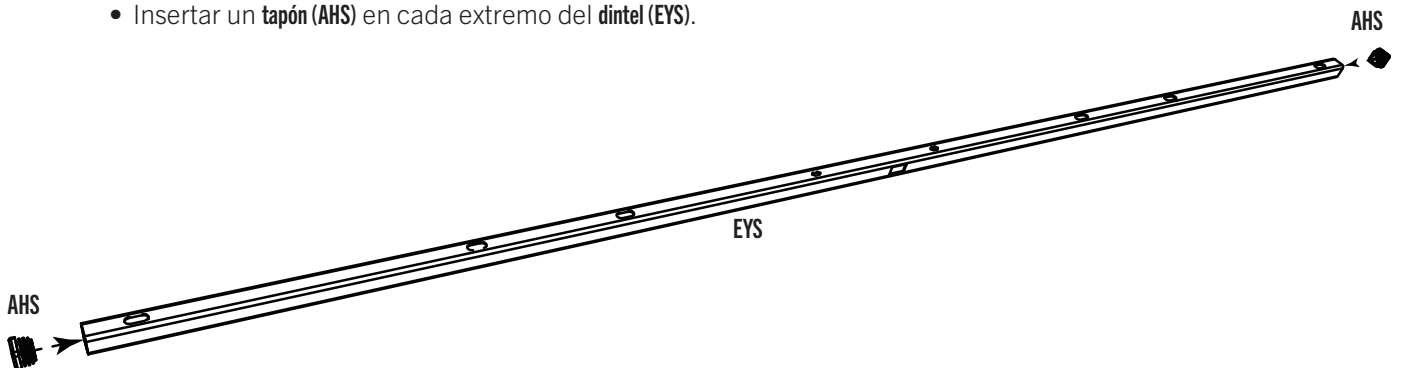

SECTION 3 (CONTINUED) / SECTION 3 (SUITE) / SECCIÓN 3 (CONTINUACIÓN)

TOOLS AND HARDWARE REQUIRED / OUTILS ET QUINCAILLERIE REQUIS / INSTRUMENTAL Y HERRAJE REQUERIDOS



3/8 in/po
(≈10 mm)

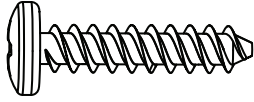

ADV (x6)

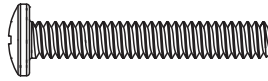

EYR (x2)

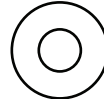

AEE (x2)



ADK (x2)

3.9

- Align the holes in the header with those in the gable.
- Aligner les trous dans le linteau avec ceux dans le pignon.
- Alinear los agujeros en el dintel con los de la fachada.



- The flat holes face away from the gable.
- Les trous plats font face de l'autre côté du pignon.
- Los agujeros lisos miran en contra de la fachada.

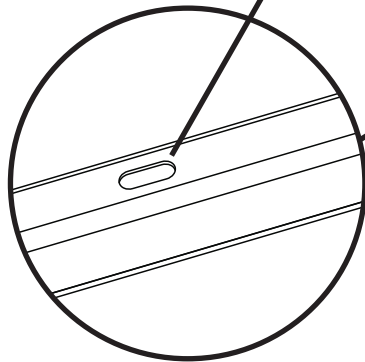

- The dented hole faces downward.
- Le trou bosselé est orienté vers le bas.
- El agujero dentado mira hacia abajo.

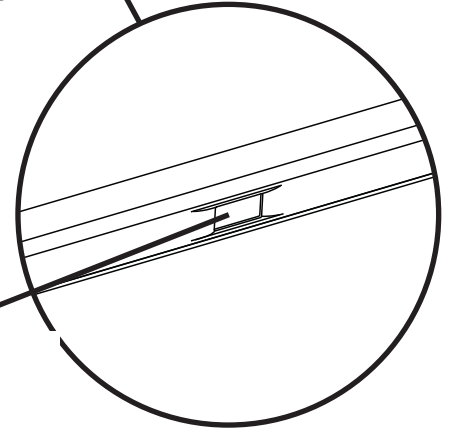

3.10

- Secure with two (2) screws (EYR), two (2) washers (AEE), and two (2) nuts (ADK). Do not overtighten.
- Le fixer à l'aide de deux (2) vis (EYR), deux (2) rondelles (AEE), et deux écrous (ADK). Ne pas trop serrer.
- Sujeterlo con dos (2) tornillos (EYR), dos (2) rondanas (AEE), y dos tuercas (ADK). No apretar demasiado.

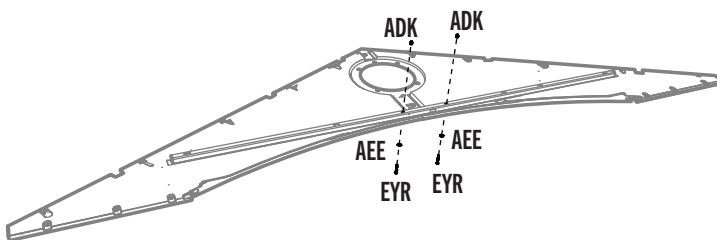

3.11

- Secure with six (6) more screws (ADV).
- Le fixer à l'aide de six (6) vis (ADV) de plus.
- Sujeterlo con seis (6) más tornillos (ADV).

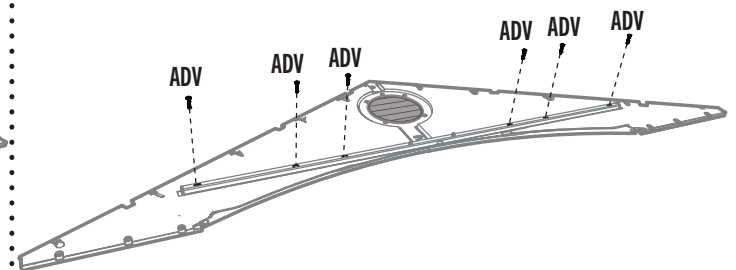

4

LEFT DOOR ASSEMBLY / ASSEMBLAGE DE LA PORTE GAUCHE / ENSAMBLAJE DE LA PUERTA IZQUIERDA



HARDWARE REQUIRED / QUINCAILLERIE REQUISE / HERRAJE REQUERIDO

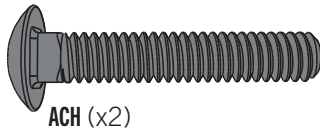

ACH (x2)



ADW (x1)

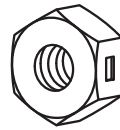

AAB (x2)

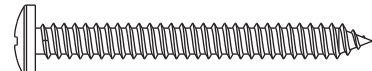

BYZ (x2)

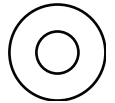

AEE (x3)

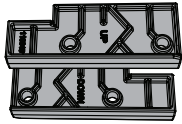

ENP (x2)

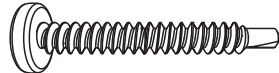

ENO (x4)



AEB (x2)

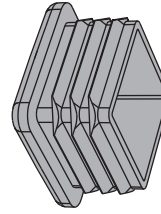

BBH (x1)



ARA (x1) 1/8 in/po (≈3 mm)

Parts / Pièces / Piezas

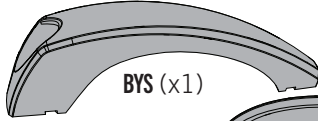

BYS (x1)



BYR (x1)

Parts / Pièces / Piezas

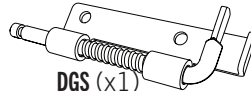

DGS (x1)

Upper / Supérieur / Superior

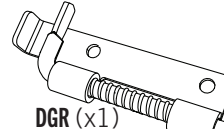

DGR (x1)

Lower / Inférieur / Inferior

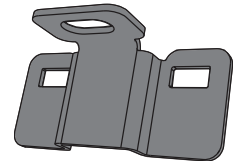

EOY (x1)



PARTS REQUIRED / PIÈCES REQUISES / PIEZAS REQUERIDAS

Metal parts / Pièces en métal / Piezas de metal



Top end / Extrémité supérieure / Extremo superior

EDW (x1)

74 2/3" (1,9 m)

CRD (x1)

77 in/po (≈1,96 m)

Plastic parts / Pièces en plastique / Piezas de plástico

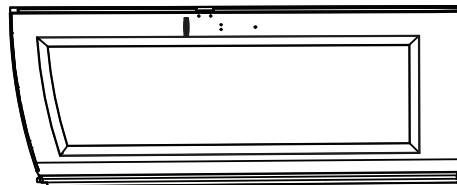

BDJ (x1)



TOOLS REQUIRED / OUTILS REQUIS / INSTRUMENTAL REQUERIDO

(Not included—unless otherwise indicated*) / (Non inclus — sauf indication contraire*) / (No incluido, salvo indicación contraria*)

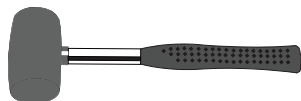

ARA (x1)*
1/8 in/po (≈3mm)



ADC (x1)*

► SECTION 4 (CONTINUED) / SECTION 4 (SUITE) / SECCIÓN 4 (CONTINUACIÓN)

TOOLS AND HARDWARE REQUIRED / OUTILS ET QUINCAILLERIE REQUIS / INSTRUMENTAL Y HERRAJE REQUERIDOS

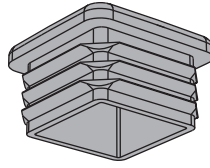

BBH (x1)



- In case of any trouble with this section, scan the QR code below to view a video on its assembly.
- En cas de problème avec cette section, scanner le QR code en dessous pour voir une vidéo de l'assemblage.
- En caso de problemas con esta sección, escanear el código QR debajo para ver un video del ensamblaje.



<http://go.lifetime.com/8x7.5-section4>

4.1

- Slide a **long tube (EDW)** into the hole in the **left door (BDJ)** until a few inches remain out of the door. **The end with the hole goes at the top.**
- Faites glisser le **tube grand (EDW)** à travers le trou de la **porte gauche (BDJ)** jusqu'à ce qu'il dépasse quelques pouces de la porte. **L'extrémité avec le trou va vers le haut.**
- Deslice el **tubo largo (EDW)** adentro del agujero en la **puerta izquierda (BDJ)** hasta que el tubo cuelgue unas pulgadas de la puerta. **El extremo con el agujero va al tope.**

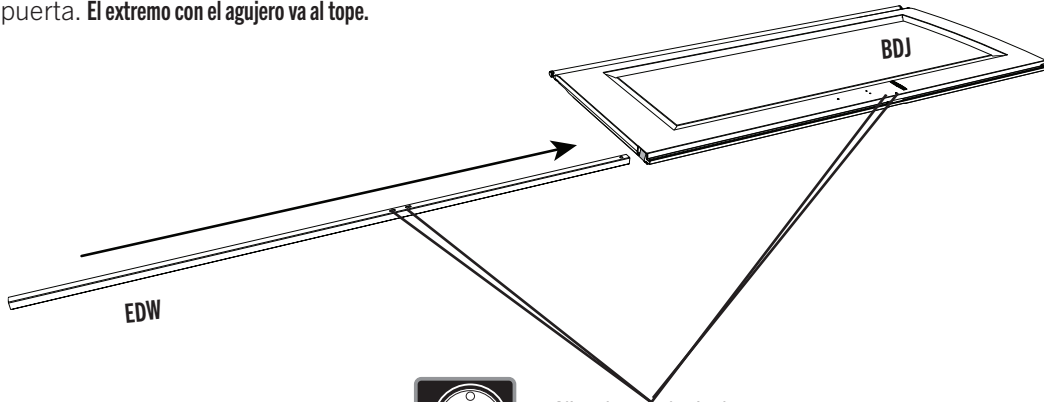

- *Align these holes in the next step*
- *Alignez ces trous à l'étape suivante*
- *Alinee estos agujeros en el paso siguiente*

4.2

- Insert an **end cap (BBH)** into the end of the tube and finish inserting the tube until flush with bottom of door and the two holes in the tube align with those in the door.
- Insérez un **capuchon (BBH)** dans l'extrémité du tube et continuez d'insérer le tube jusqu'à ce qu'il soit à ras au bord inférieur de la porte et les deux trous dans le tube s'alignent avec ceux dans la porte.
- Inserte un **tapon (BBH)** adentro del extremo del tubo y siga con la inserción del tubo hasta que esté al ras del borde inferior de la puerta y los dos agujeros en el tubo se alineen con ellos en la puerta.

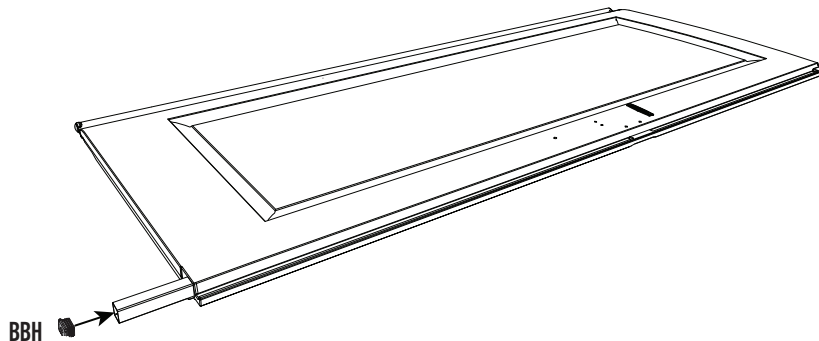

SECTION 4 (CONTINUED) / SECTION 4 (SUITE) / SECCIÓN 4 (CONTINUACIÓN)

TOOLS AND HARDWARE REQUIRED / OUTILS ET QUINCAILLERIE REQUIS / INSTRUMENTAL Y HERRAJE REQUERIDOS



1/8 in/po
(≈3 mm)
ARA (x1)

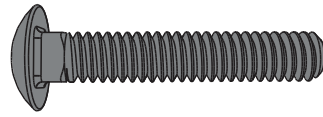

ACH (x2)

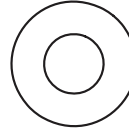

AEB (x2)

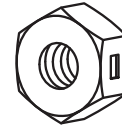

AAB (x2)

4.3

- Attach the **left latch bracket (EOY)** to the door using the hardware included. **Do not overtighten.**
- Attachez le **support gauche à loquet (EOY)** à la porte à l'aide de la quincaillerie incluse. **Ne pas trop serrer.**
- Sujete el **soporte izquierdo para el pestáneo (EOY)** a la puerta usando el herraje incluido. **No apretar demasiado.**

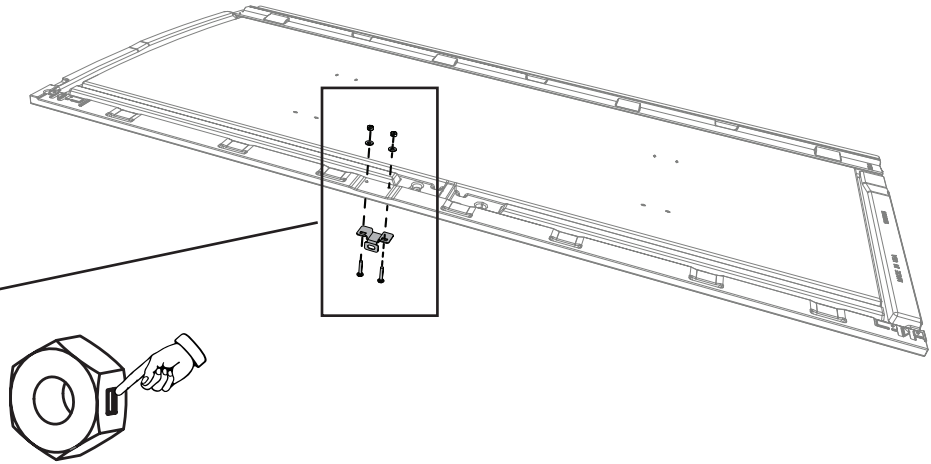
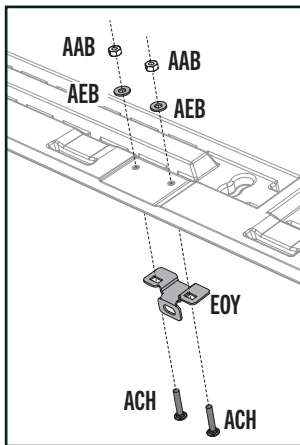

4.4

- Drill into the divots at the top and bottom of the door and into the tube inside but not all the way through the door. Use the **1/8" (3 mm) drill bit (ARA)** included.
- Percez les marques à la partie supérieure et inférieure de la porte et dedans le tube à l'intérieur mais pas à travers la porte entière. Utilisez le **foret de 3 mm (1/8 po) (ARA)** inclus.
- Taladre las marcas al tope y al fondo de la puerta y dentro del tubo adentro mas no por la puerta entera. Use la **broca de 3 mm (1/8 in.) (ARA)** incluida.

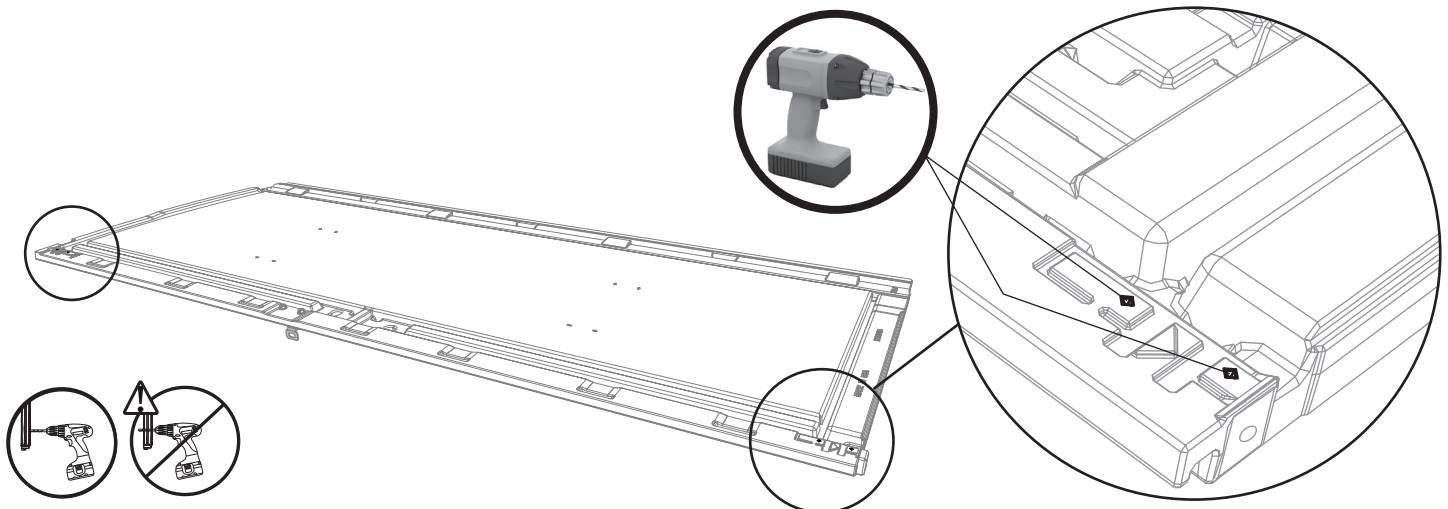

SECTION 4 (CONTINUED) / SECTION 4 (SUITE) / SECCIÓN 4 (CONTINUACIÓN)

TOOLS AND HARDWARE REQUIRED / OUTILS ET QUINCAILLERIE REQUIS / INSTRUMENTAL Y HERRAJE REQUERIDOS

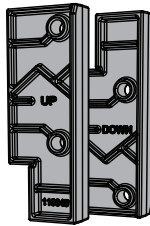
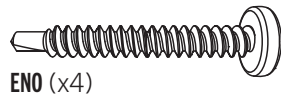
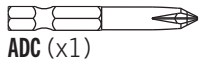

ENP (x2)

4.5

- Attach the locks (DGR & DGS) and spacers (ENP) to the top and bottom of the left door. If the pins in the locks do not move freely, loosen the screws (ENO) just a tad.
- Attachez les verrous (DGR et DGS) et les pièces d'écartement (ENP) à la partie supérieure et inférieure à la porte gauche. Si les verrous ne se déplacent pas librement, deserre les vis (ENO) un petit peu.
- Sujete los pasadores (DGR y DGS) y los espaciadores (ENP) al tope y al fondo de la Puerta izquierda. Si los pasadores no se mueven libremente, afloje los tornillos (ENO) un poquito.

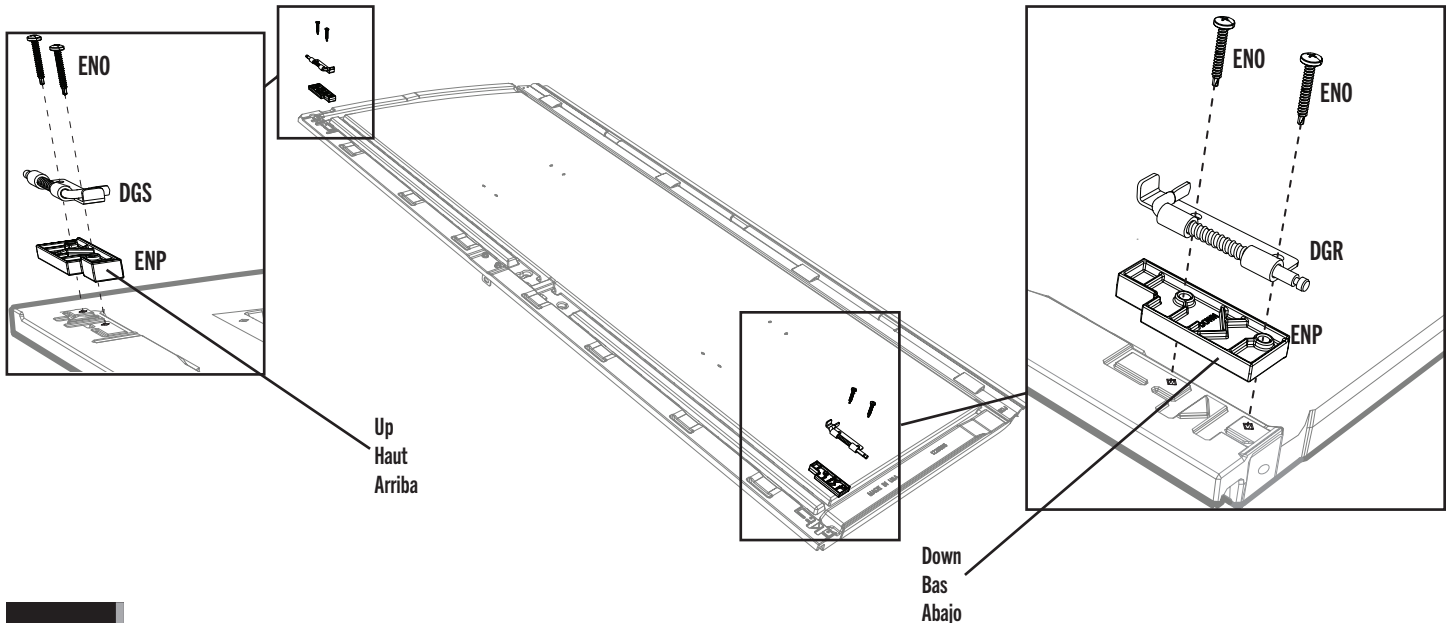

4.6

- Attach the two handle pieces (BYR & BYS) together as shown.
- Attachez les deux pièces de la poignée (BYR et BYS) comme illustré.
- Conecte las dos piezas del picaporte (BYR y BYS) como se muestra.

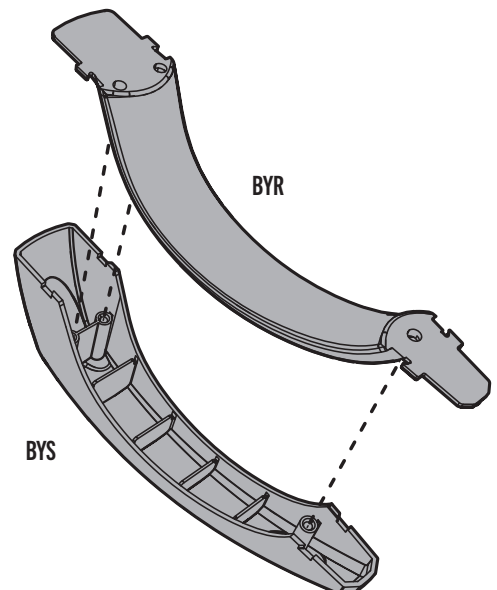

► SECTION 4 (CONTINUED) / SECTION 4 (SUITE) / SECCIÓN 4 (CONTINUACIÓN)

TOOLS AND HARDWARE REQUIRED / OUTILS ET QUINCAILLERIE REQUIS / INSTRUMENTAL Y HERRAJE REQUERIDOS

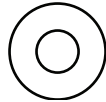

AEE (x3)

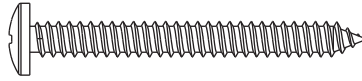

BYZ (x2)

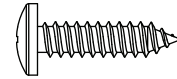

ADW (x1)

4.7

- Attach the handle to the door using the hardware included.
- Attachez la poignée à la porte à l'aide de la quincaillerie incluse.
- Sujete el picaporte a la puerta usando el herraje incluido.

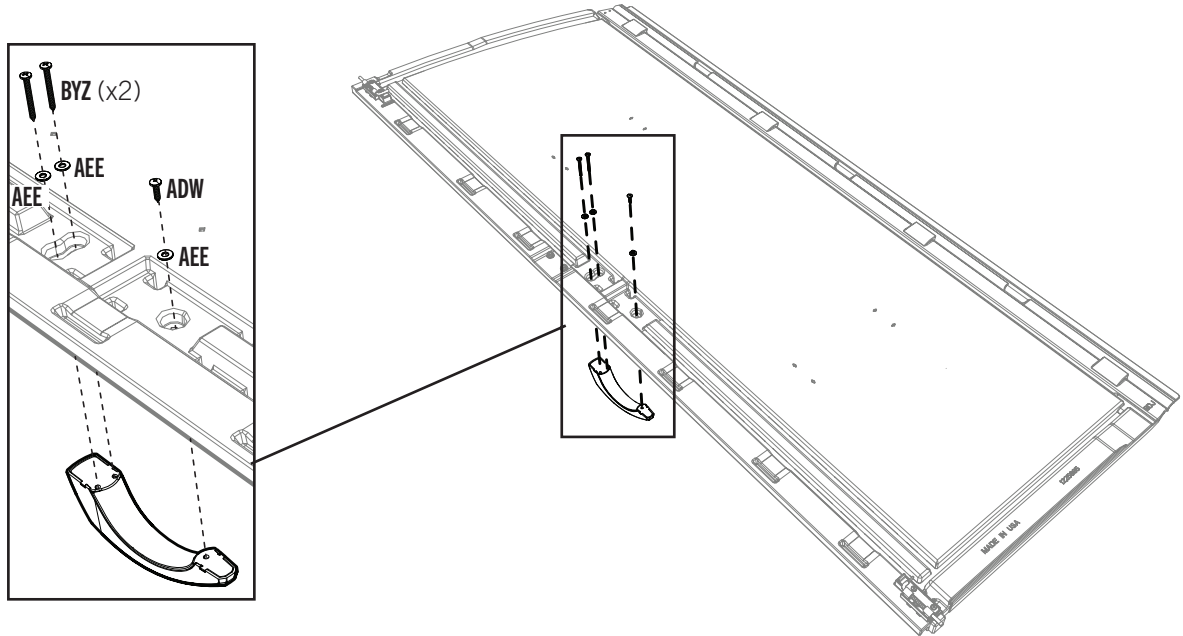

4.8

- Slide a **hinge tube (CRD)** into the hole in the door until a few inches remain out of the bottom.
- Faites glisser le **tube de charnière (CRD)** à travers le trou de la porte jusqu'à ce qu'il dépasse quelques pouces de la partie inférieure de la porte.
- Deslice un **tubo de bisagra (CRD)** adentro del agujero en la puerta hasta que el tubo cuelgue unas pulgadas de la parte inferior de la puerta.

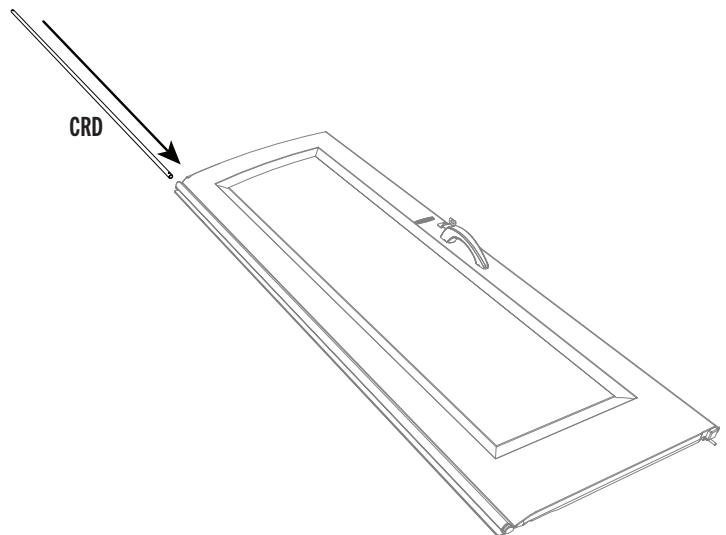

5

RIGHT DOOR ASSEMBLY / ASSEMBLAGE DE LA PORTE DROITE / ENSAMBLAJE DE LA PUERTA DERECHA



HARDWARE REQUIRED / QUINCAILLERIE REQUISE / HERRAJE REQUERIDO

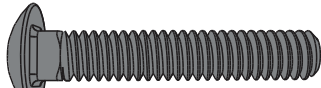

ACH (x2)

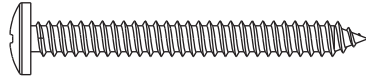

BYZ (x2)

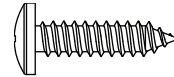

ADW (x1)

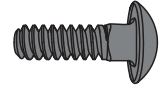

EPC (x2)

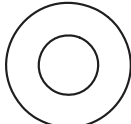

AEB (x2)

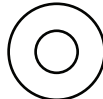

AEE (x3)

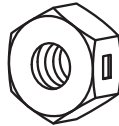

AAB (x2)

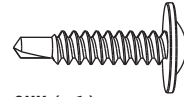

CHK (x1)



CXK (x2)

Parts / Pièces / Piezas



EOZ (x1)

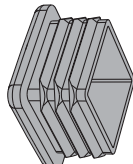

BBH (x1)



EPA (x1)

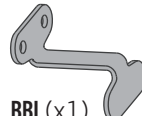

BBI (x1)

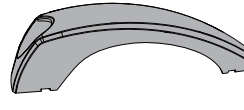

BYS (x1)



BYR (x1)



PARTS REQUIRED / PIÈCES REQUISES / PIEZAS REQUERIDAS

Metal parts / Pièces en métal / Piezas de metal



Top end / Extrémité supérieure / Extremo superior



EDW (x1)

74 2/3 in/po (≈1,9 m)

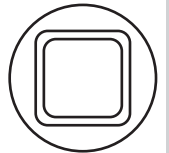

CRD (x1)

77 in/po (≈1.96 m)

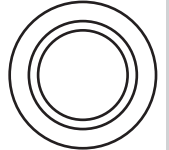

Plastic parts / Pièces en plastique / Piezas de plástico



BDK (x1)



TOOLS REQUIRED / OUTILS REQUIS / INSTRUMENTAL REQUERIDO

(Not included—unless otherwise indicated*) / (Non inclus — sauf indication contraire*) / (No incluido, salvo indicación contraria*)

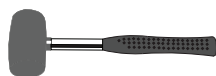

7/16 in/po (≈11 mm)



3/8 in/po (≈10 mm)

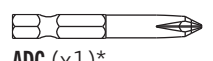

ADC (x1)*

► SECTION 5 (CONTINUED) / SECTION 5 (SUITE) / SECCIÓN 5 (CONTINUACIÓN)

TOOLS AND HARDWARE REQUIRED / OUTILS ET QUINCAILLERIE REQUIS / INSTRUMENTAL Y HERRAJE REQUERIDOS

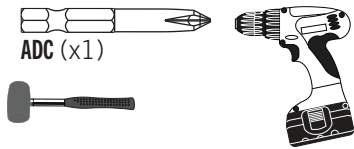

- In case of any trouble with this section, scan the QR code below to view a video on its assembly.
- En cas de problème avec cette section, scanner le QR code en dessous pour voir une vidéo de l'assemblage.
- En caso de problemas con esta sección, escanear el código QR debajo para ver un video del ensamblaje.



<http://go.lifetime.com/8x7.5-section5>

5.1

- Slide a **square tube (EDW)** into the hole in the **right door (BDK)** until a few inches remain out of the door. **The end with the hole goes at the top.**
- Faire glisser le **tube carré (EDW)** à travers le trou de la **porte droite (BDK)** jusqu'à ce qu'il dépasse de quelques centimètres de la porte. **L'extrémité avec le trou va en haut.**
- Deslizar el **tubo cuadrado (EDW)** adentro del agujero en la **puerta derecha (BDK)** hasta que el tubo cuelgue unas pulgadas de la puerta. **El extremo con el agujero va al tope.**

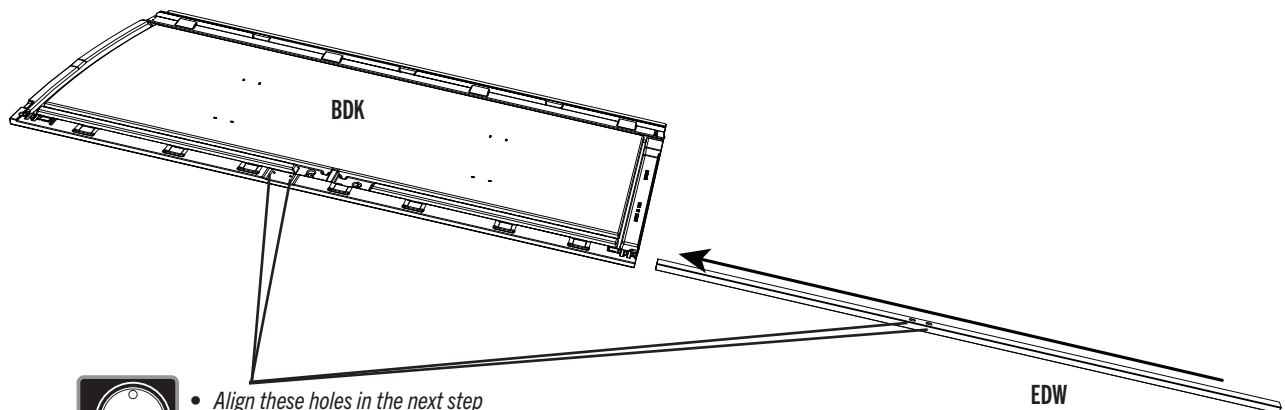

- *Align these holes in the next step*
- *Aligner ces trous à l'étape suivante*
- *Alinear estos agujeros en el paso siguiente*

5.2

- Insert an **end cap (BBH)** into the end of the tube, and finish inserting the tube until flush with bottom of door. Then, use a drill to insert a **self-drilling screw (CHK)** to hold it in place.
- Insérer un **capuchon (BBH)** dans l'extrémité du tube, et terminer d'insérer le tube jusqu'à ce qu'il soit à ras au bord inférieur de la porte. Puis, utiliser une perceuse pour insérer une **vis autotaraudeuse (CHK)** pour la maintenir en place.
- Insertar un **tapon (BBH)** en el extremo del tubo, y terminar de insertar el tubo hasta se alinee con la parte inferior de la puerta. Después, usar un taladro eléctrico para insertar un **ornillo auto-perforante (CHK)** para mantenerlo en su lugar.

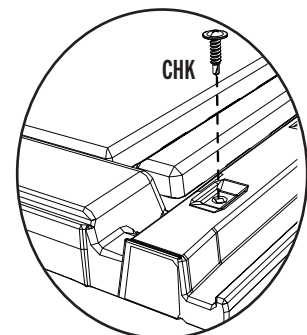
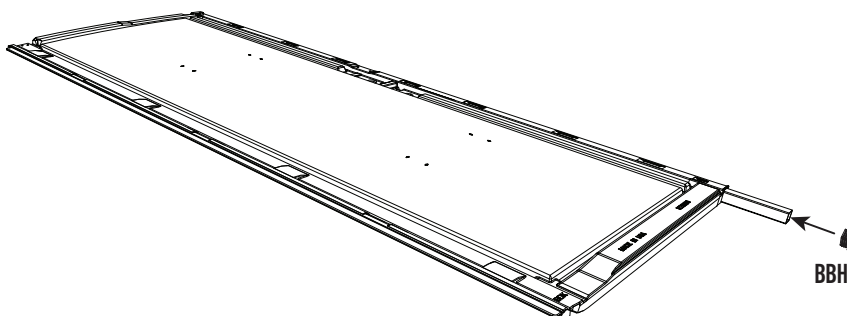

► SECTION 5 (CONTINUED) / SECTION 5 (SUITE) / SECCIÓN 5 (CONTINUACIÓN)

TOOLS AND HARDWARE REQUIRED / OUTILS ET QUINCAILLERIE REQUIS / INSTRUMENTAL Y HERRAJE REQUERIDOS



7/16 in/po
(≈11 mm)



3/8 in/po
(≈10 mm)

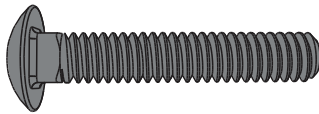

ACH (x2)

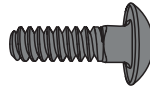

EPC (x2)

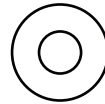

AEE (x2)

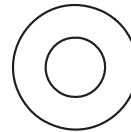

AEB (x2)

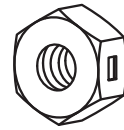

AAB (x2)



CXK (x2)

5.3

- Ensure the tube inside the door is flush with the bottom of the door. Attach the latch as shown.
- Veiller à ce que le tube dans la porte soit à ras au bord inférieur de la porte. Attacher le loquet comme indiqué.
- Asegurarse de que el tubo dentro de la puerta esté a ras del borde inferior de la puerta. Entonces, sujetar bien el pestajo como se muestra.

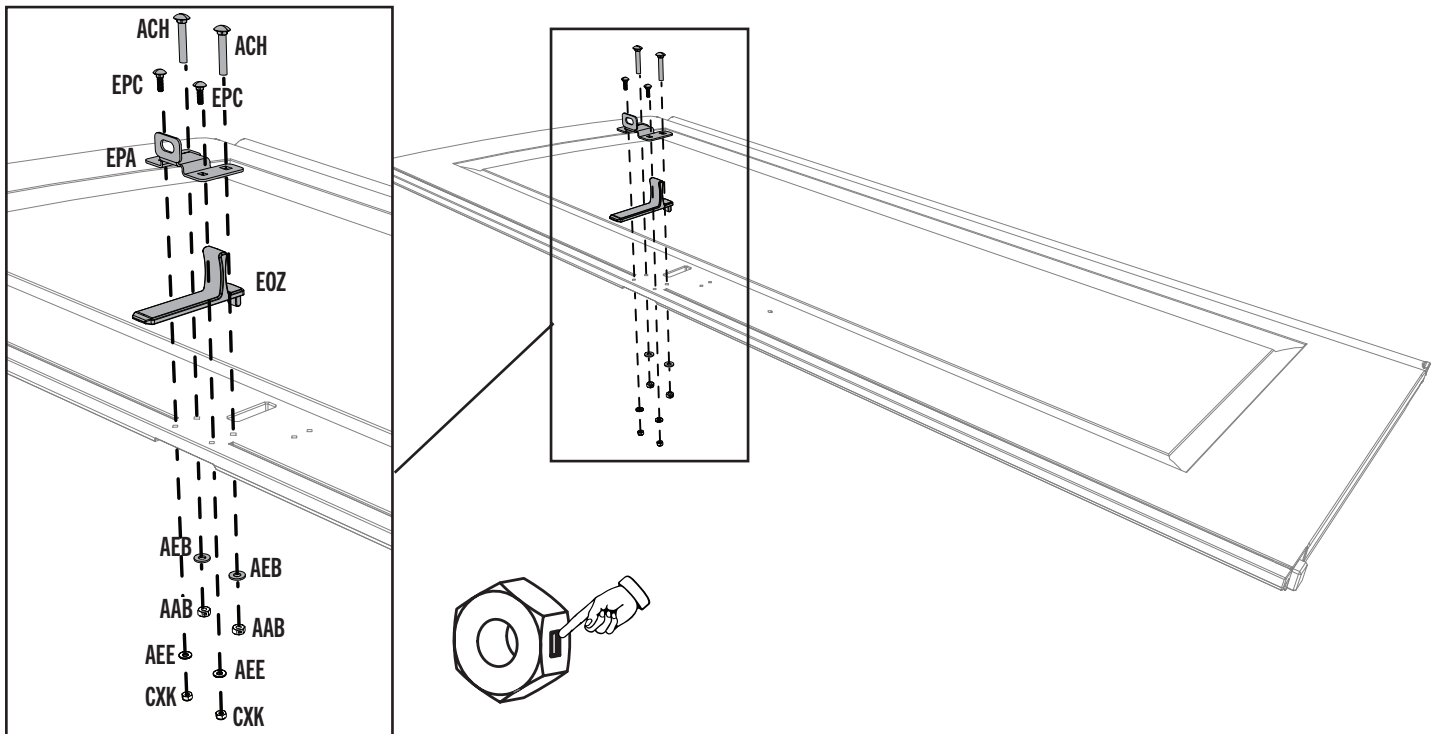

5.4

- Attach the two **handle pieces (BYR & BYS)** together as shown.
- Attacher les deux pièces de la **poignée (BYR et BYS)** comme indiqué.
- Conectar las dos piezas del **picaporte (BYR y BYS)** como se muestra.

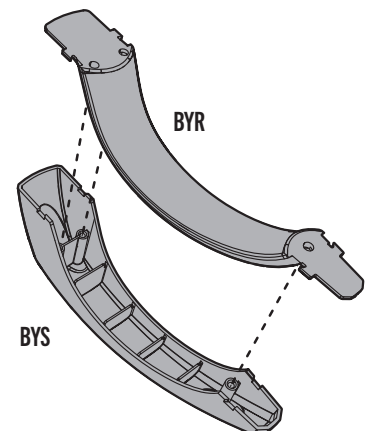

► SECTION 5 (CONTINUED) / SECTION 5 (SUITE) / SECCIÓN 5 (CONTINUACIÓN)

TOOLS AND HARDWARE REQUIRED / OUTILS ET QUINCAILLERIE REQUIS / INSTRUMENTAL Y HERRAJE REQUERIDOS

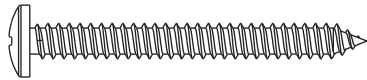

BYZ (x2)

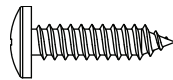

ADW (x1)

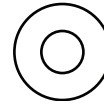

AEE (x1)

5.5

- Attach the handle as shown. **Tighten securely.**
- Bien attacher la poignée comme indiqué. **Bien serrer la quincaillerie.**
- Sujetar bien el picaporte como se muestra. **Apretar bien el herraje.**

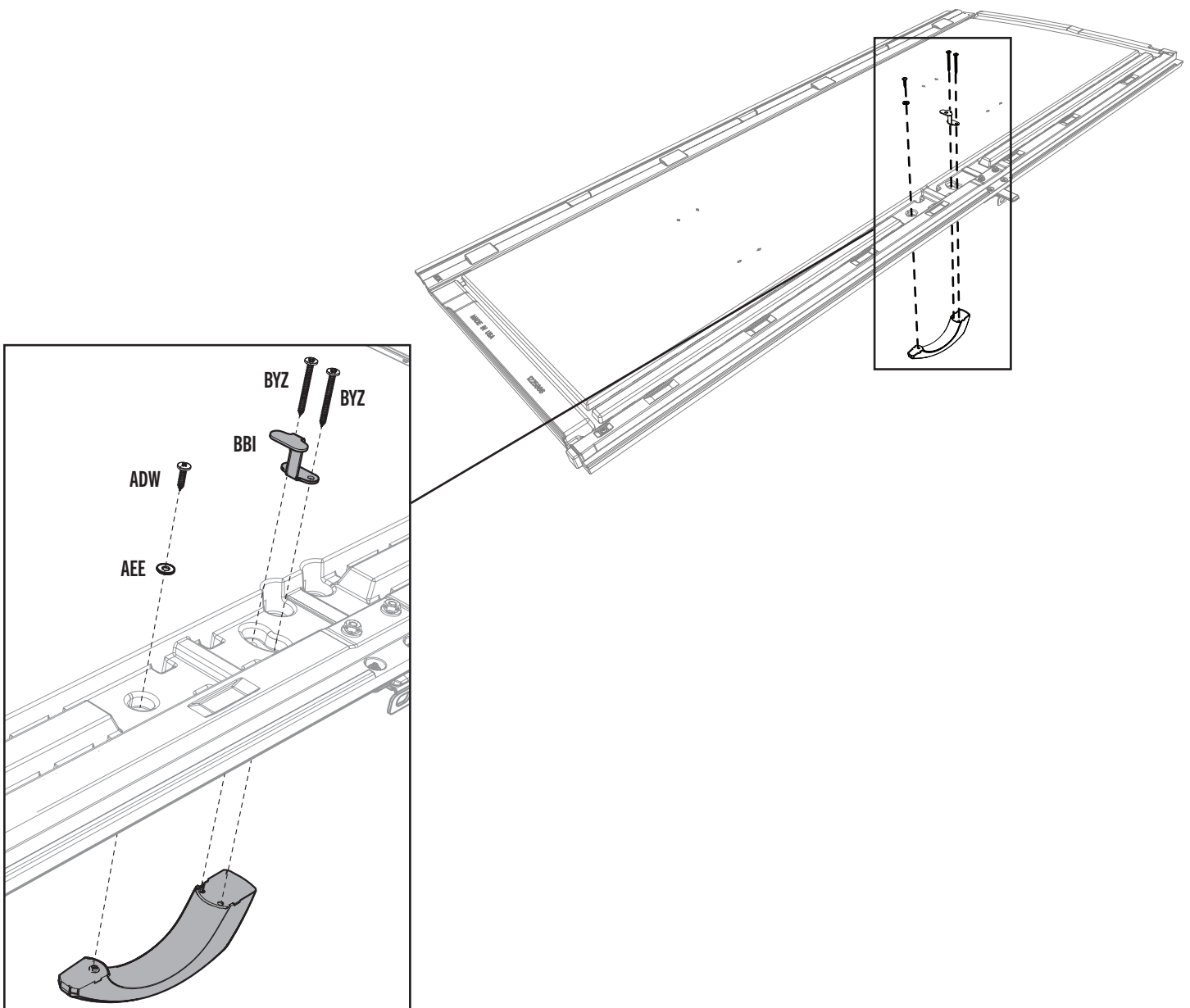

► SECTION 5 (CONTINUED) / SECTION 5 (SUITE) / SECCIÓN 5 (CONTINUACIÓN)

TOOLS AND HARDWARE REQUIRED / OUTILS ET QUINCAILLERIE REQUIS / INSTRUMENTAL Y HERRAJE REQUERIDOS



5.6

- Slide a **hinge tube (CRD)** into the hole in the door until a few inches remain out of the bottom.
- Faire glisser le **tube de articulation (CRD)** à travers le trou de la porte jusqu'à ce qu'il dépasse de quelques centimètres de la partie inférieure de la porte.
- Deslizar un **tubo de articulación (CRD)** adentro del agujero en la puerta hasta que el tubo cuelgue unas pulgadas de la parte inferior de la puerta.

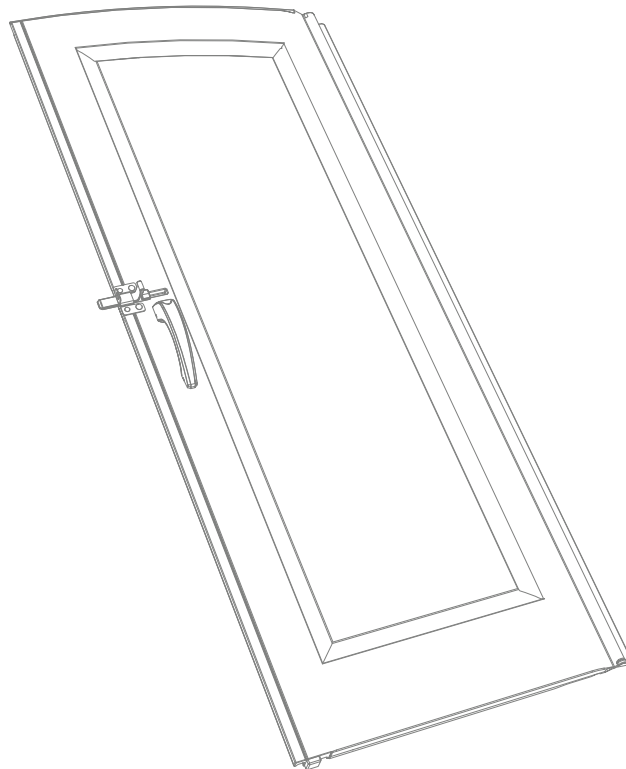
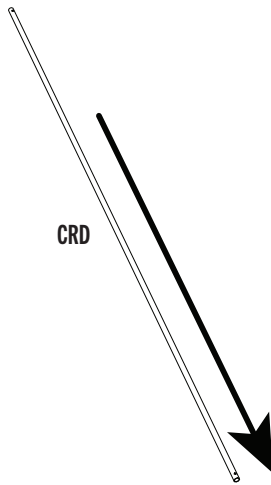

6

FLOOR ASSEMBLY / ASSEMBLAGE DU PLANCHER / ENSAMBLAJE DEL PISO



HARDWARE REQUIRED / QUINCAILLERIE REQUISE / HERRAJE REQUERIDO



AHL (x1)

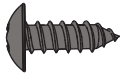

CWU (x18)*

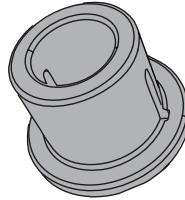

AHO (x2)



ADC (x1)



- These are not anchoring screws. Their purpose is to fasten together the floor panels.
- Ces vis ne sont pas les vis d'ancrage. Leur but est pour attacher les panneaux de plancher.
- Estos no son tornillos de anclaje. Son propósito es sólo para unir los paneles de piso.



- * Not all hardware will be used in the section.
- * La quincaillerie n'est pas utilisée au complet dans la section.
- * No se utilizará todo el herraje en la sección.



PARTS REQUIRED / PIÈCES REQUISES / PIEZAS REQUERIDAS

Plastic parts / Pièces en plastique / Piezas de plástico

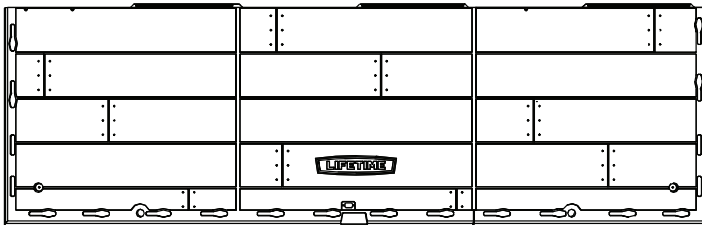

CUW (x2)

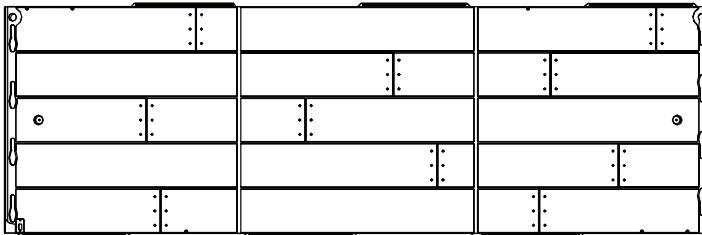

CUD (x1)

- *Unfold the floor panels before installing.*
- *Dépliez les panneaux de sol avant l'installation.*
- *Despliegue los paneles del suelo antes de instalar.*



TOOLS REQUIRED / OUTILS REQUIS / INSTRUMENTAL REQUERIDO

(Not included—unless otherwise indicated*) / (Non inclus — sauf indication contraire*) / (No incluido, salvo indicación contraria*)



▶ SECTION 6 (CONTINUED) / SECTION 6 (SUITE) / SECCIÓN 6 (CONTINUACIÓN)

TOOLS AND HARDWARE REQUIRED / OUTILS ET QUINCAILLERIE REQUIS / INSTRUMENTAL Y HERRAJE REQUERIDOS



- In case of any trouble with this section, scan the QR code below to view a video on its assembly.
- En cas de problème avec cette section, scanner le QR code en dessous pour voir une vidéo de l'assemblage.
- En caso de problemas con esta sección, escanear el código QR debajo para ver un video del ensamblaje.



<http://go.lifetime.com/8x7.5-section6>



- *Unfold the floor panels before installing.*
- *Dépliez les panneaux de sol avant l'installation.*
- *Despliegue los paneles del suelo antes de instalar.*

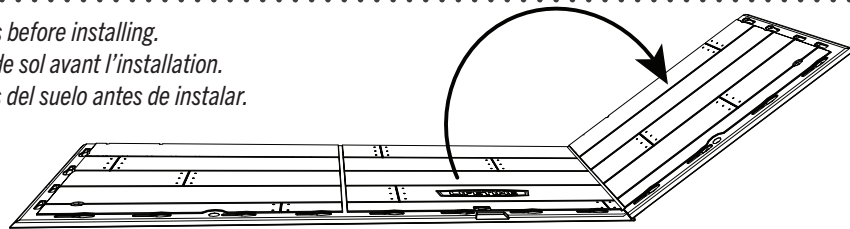

6.1

- Hold an **inner floor panel (CUD)** at an angle and slide the tabs along the edge underneath an **outer floor panel (CUW)**. The tabs interlock. Lay panel down flat.
- Poser un **panneau de plancher intérieur (CUD)** à un angle et faire glisser les languettes le long du bord au-dessus du **panneau de plancher extérieur (CUW)**. Les languettes s'enclenchent les uns les autres. L'étendre par terre.
- Colocar un **panel de piso interior (CUD)** a un ángulo y deslizar las lengüetas a lo largo del borde debajo el **panel de piso exterior (CUW)**. Las lengüetas se entrelazan las unas con las otras. Aplanar el panel.

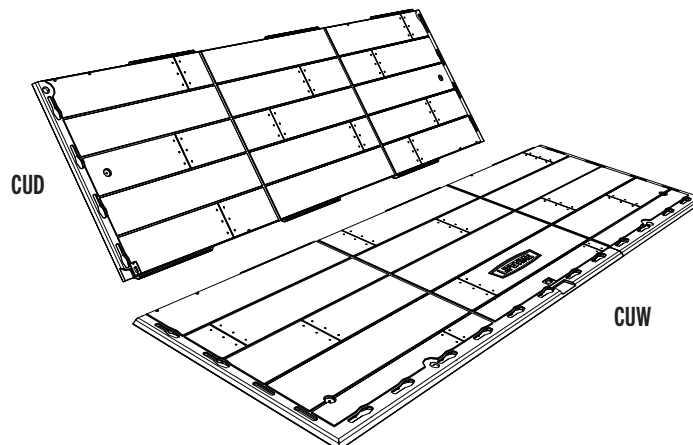

► SECTION 6 (CONTINUED) / SECTION 6 (SUITE) / SECCIÓN 6 (CONTINUACIÓN)

TOOLS AND HARDWARE REQUIRED / OUTILS ET QUINCAILLERIE REQUIS / INSTRUMENTAL Y HERRAJE REQUERIDOS

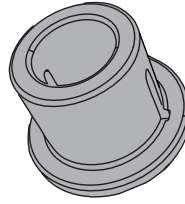

AHO (x2)

6.2

- Attach an **outer floor panel (CUW)** to the inner floor panel.
- Attacher un autre **panneau de plancher intérieur (CUW)** au panneau de plancher intérieur.
- Fijar otro **panel de piso exterior (CUW)** al panel de piso interior.

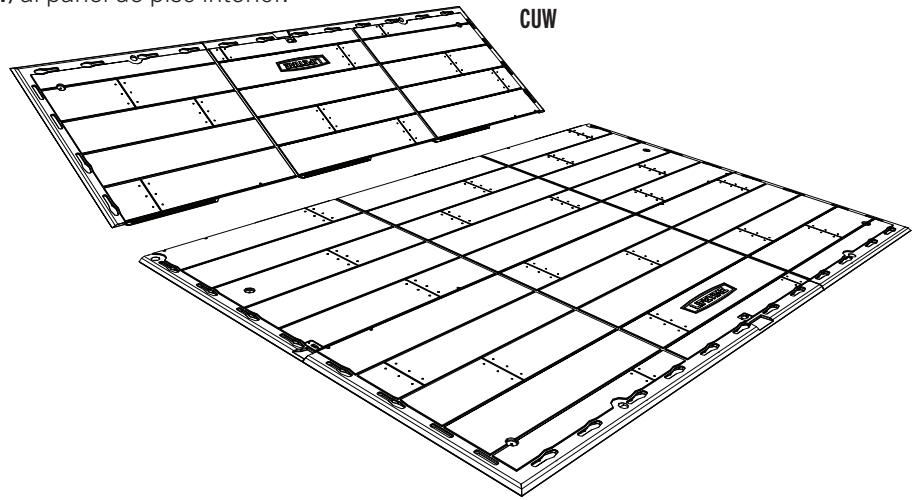

6.3

- Decide on which end you would like to install your doors. Insert **bushings (AHO)** through the holes in the floor. **The slit in the bushing should face the front of the shed.**
- Choisir le bord auquel installer les portes. Insérer les **bagues (AHO)** à travers les trous dans le plancher. **La fente dans la bague doit donner sur le bord avant de l'abri.**
- Escojer en que borde instalar las puertas. Insertar los **casquillos (AHO)** a través de los agujeros en el piso. **La rendija en el casquillo debe dar hacia el borde delantero de la caseta.**

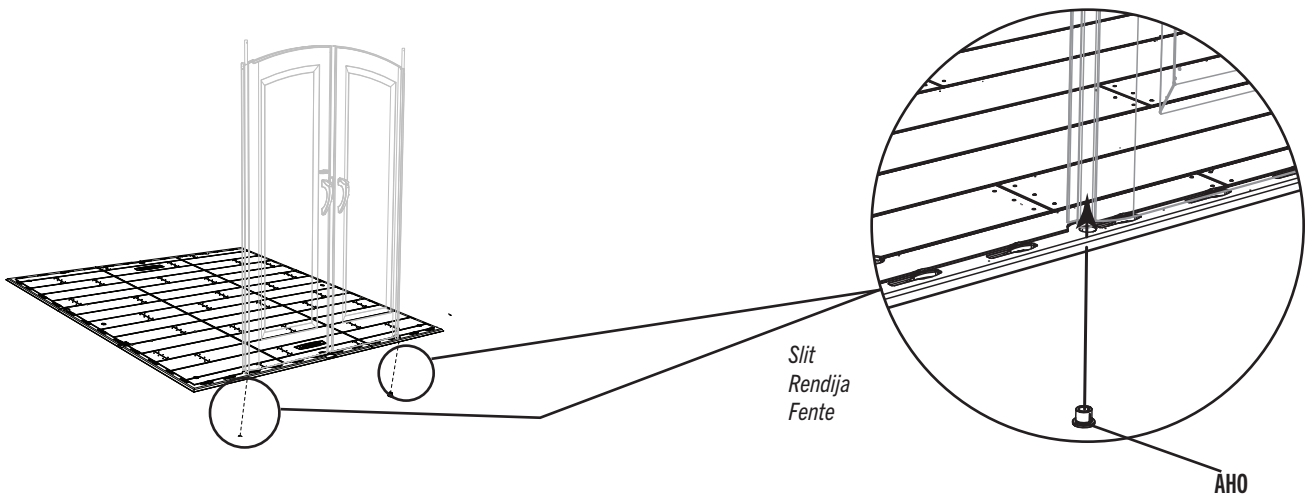

SECTION 6 (CONTINUED) / SECTION 6 (SUITE) / SECCIÓN 6 (CONTINUACIÓN)

TOOLS AND HARDWARE REQUIRED / OUTILS ET QUINCAILLERIE REQUIS / INSTRUMENTAL Y HERRAJE REQUERIDOS

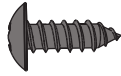

CWU (x10)



AHL (x1)



- These are not anchoring screws. Their purpose is to fasten together the floor panels.
- Ces vis ne sont pas les vis d'ancrage. Leur but est pour attacher les panneaux de plancher.
- Estos no son tornillos de anclaje. Son propósito es sólo para unir los paneles de piso.

6.4

- Insert **screws (CWU)** through the divots in the floor panels and into the tabs of the adjacent floor panels. (The divots are near the seams.)
- Insérer les **vis (CWU)** à travers les marques dans les panneaux de plancher et dans les languettes du panneaux de plancher contigu. (Les marques se trouvent près des jonctions.)
- Insertar los **tornillos (CWU)** a través de las marcas en los paneles de piso y dentro de las lengüetas de los paneles de piso adyacentes. (Se encuentran las marcas cerca de las juntas.)

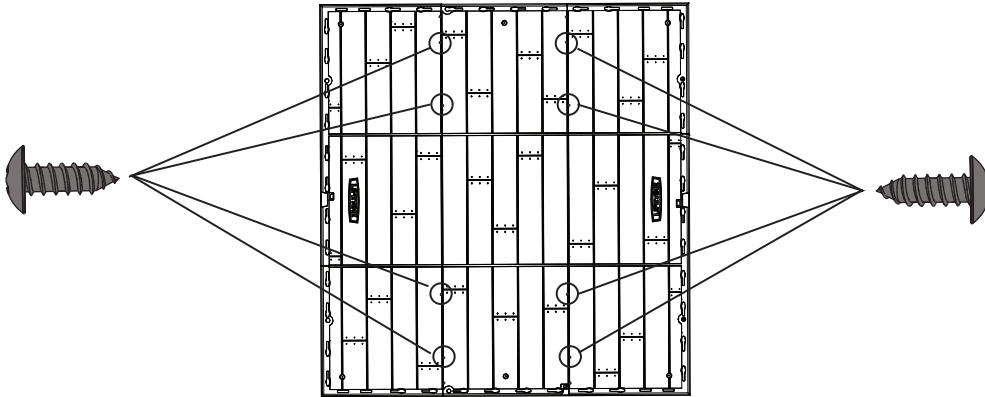

6.5

- Attach the **strike plate (AHL)** to the floor on the same side the bushings were installed.
- Attacher la **gâche (AHL)** au plancher sur le même côté que celui où les bagues ont été installées.
- Fijar la **placa de impacto (AHL)** al piso en el mismo lado donde se instalaron los casquillos.

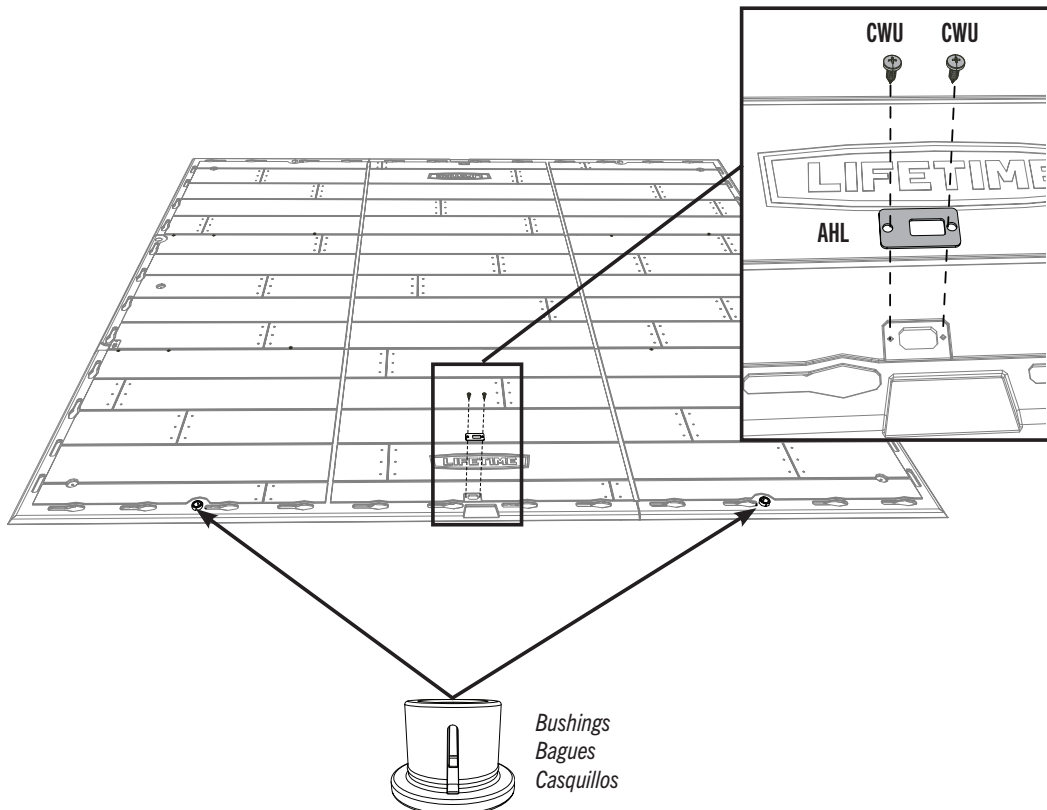

7

WALL ASSEMBLY / ASSEMBLAGE DES MURS / ENSAMBLAJE DE LOS MUROS



HARDWARE REQUIRED / QUINCAILLERIE REQUISE / HERRAJE REQUERIDO

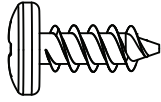

ADZ (x85)*

- * Not all hardware will be used in the section.
- * La quincaillerie n'est pas utilisée au complet dans la section.
- * No se utilizará todo el herraje en la sección.



PARTS REQUIRED / PIÈCES REQUISES / PIEZAS REQUERIDAS

Metal parts / Pièces en métal / Piezas de metal

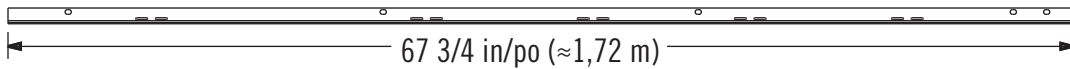

AFM (x6)

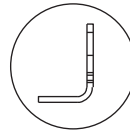

Plastic parts / Pièces en plastique / Piezas de plástico

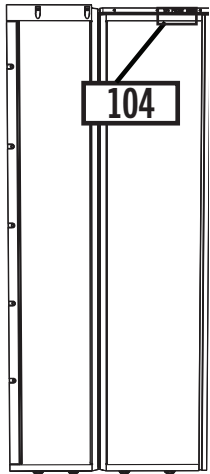

AGY (x1)

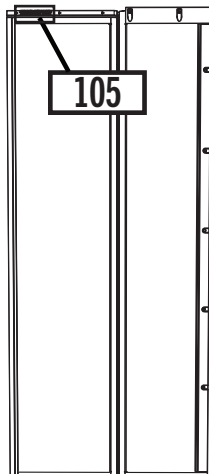

AGN (x1)

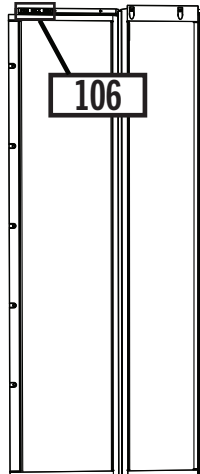

AGW (x1)

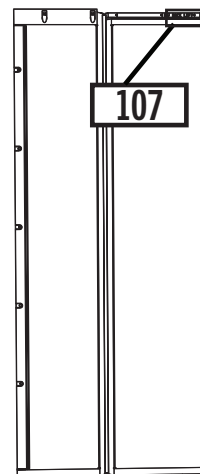

AGL (x1)

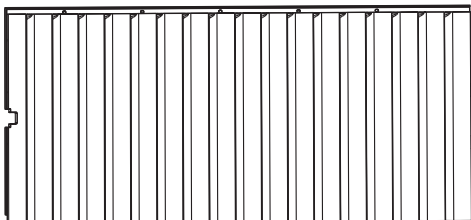

AHD (x6)

Parts / Pièces / Piezas



AIW (x1)



TOOLS REQUIRED / OUTILS REQUIS / INSTRUMENTAL REQUERIDO

(Not included—unless otherwise indicated*) / (Non inclus — sauf indication contraire*) / (No incluido, salvo indicación contraria*)



► SECTION 7 (CONTINUED) / SECTION 7 (SUITE) / SECCIÓN 7 (CONTINUACIÓN)

TOOLS AND HARDWARE REQUIRED / OUTILS ET QUINCAILLERIE REQUIS / INSTRUMENTAL Y HERRAJE REQUERIDOS

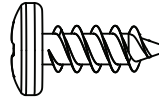
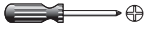

ADZ (x4)



- In case of any trouble with this section, scan the QR code below to view a video on its assembly.
- En cas de problème avec cette section, scanner le QR code en dessous pour voir une vidéo de l'assemblage.
- En caso de problemas con esta sección, escanear el código QR debajo para ver un video del ensamblaje.



<http://go.lifetime.com/8x7.5-section7>

7.1

- Insert a **wall support channel (AFM)** into the groove on the front-left corner **wall panel (AGN)** and secure using four (4) **screws (ADZ)**.
- Insérer un **support mural (AFM)** dans la rainure du **panneau mural avant gauche (AGN)** et bien le fixer à l'aide de quatre (4) **vis (ADZ)**.
- Insertar un **soporte mural (AFM)** en la ranura en el **panel mural delantero izquierdo (AGN)** y fijarlo bien usando cuatro (4) **tornillos (ADZ)**.

- Top end
- Extrémité supérieure
- Extremo superior



- No screw in top hole.
- Aucune vis dans le trou supérieur.
- Ningún tornillo en el agujero superior.

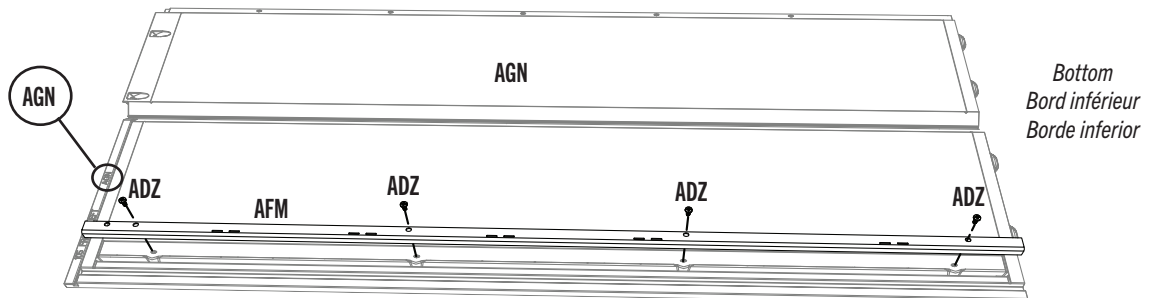



PARTS IDENTIFIER / IDENTIFICATEUR DE PIÈCES / IDENTIFICADOR DE PIEZAS

CONTENTS OF BOX 1 / CONTENU DE LA BOÎTE 1 / CONTENIDO DE LA CAJA 1

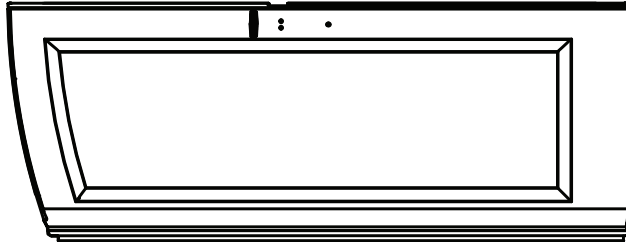

BDJ (x1)

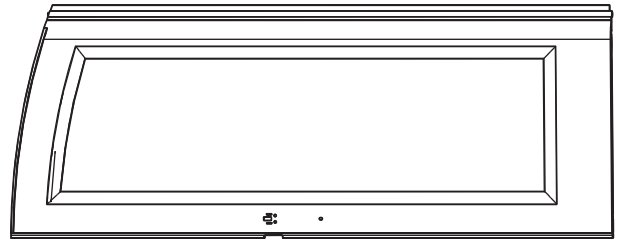

BDK (x1)

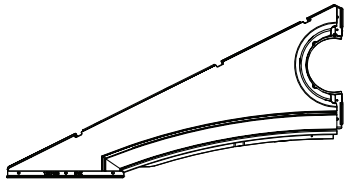

EVZ (x1)

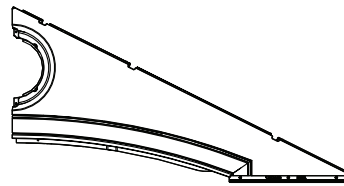

EWA (x1)

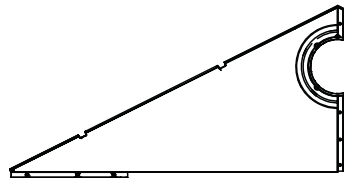

AGI (x1)

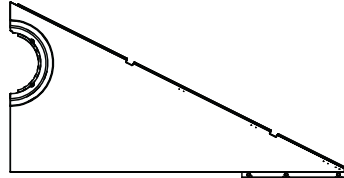

AGH (x1)

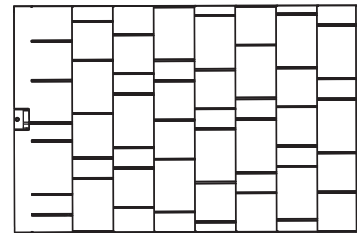

AGQ (x6)

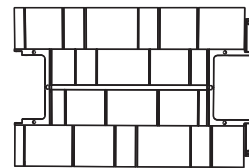

AFY (x2)

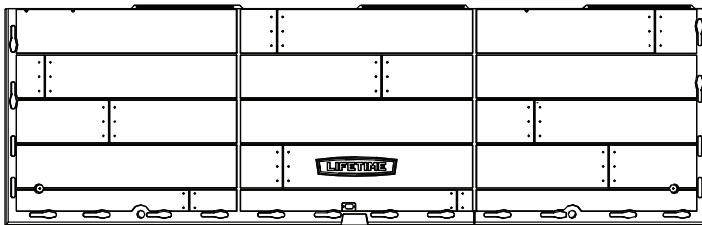

CUW (x2)

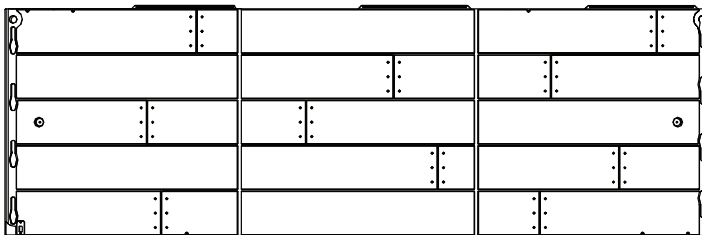

CUD (x1)

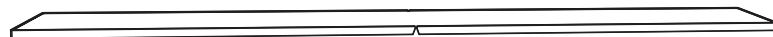

AFV (x1)

Remove this section for quick reference / Enlevez cette section pour référence rapide / Retire esta sección para referencia rápida



PARTS IDENTIFIER / IDENTIFICATEUR DE PIÈCES / IDENTIFICADOR DE PIEZAS

CONTENTS METAL KIT / CONTENU DU KIT DE PIÈCES EN MÉTAL / CONTENIDO DEL KIT DE PIEZAS DE METAL



Remove this section for quick reference / Enlevez cette section pour référence rapide / Retire esta sección para referencia rápida

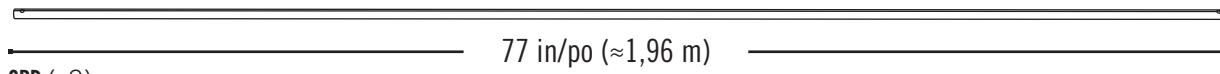

CRD (x2)

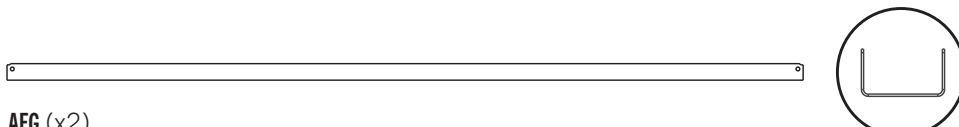

AFG (x2)

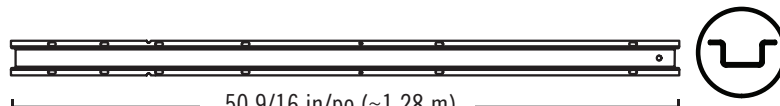

DSR (x4)

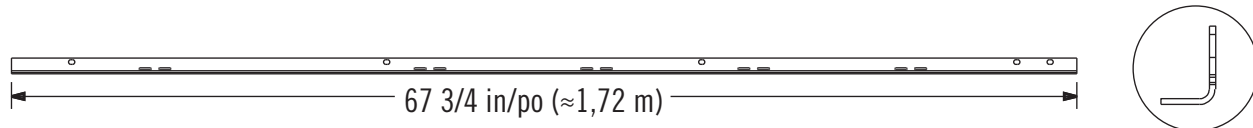

AFM (x8)

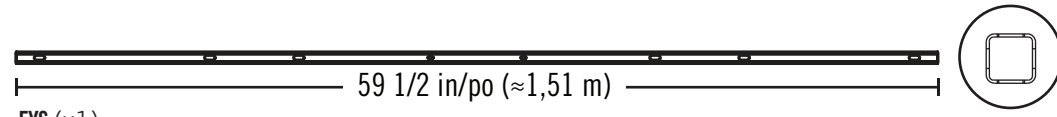

EYS (x1)

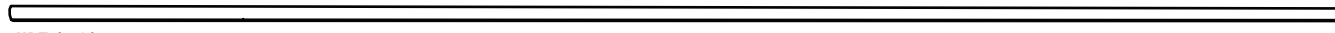

HDT (x1)



HDU (x1)

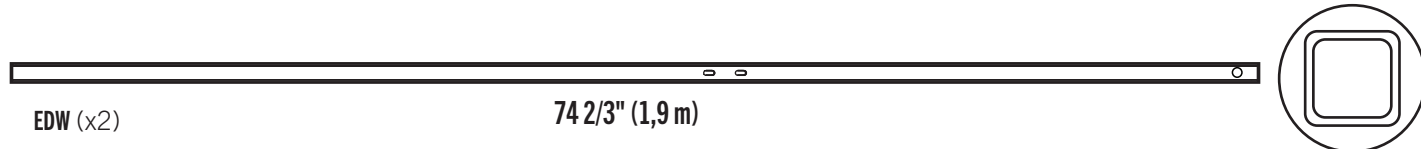

EDW (x2)



PARTS IDENTIFIER / IDENTIFICATEUR DE PIÈCES / IDENTIFICADOR DE PIEZAS

CONTENTS OF BOX 2 / CONTENU DE LA BOÎTE 2 / CONTENIDO DE LA CAJA 2

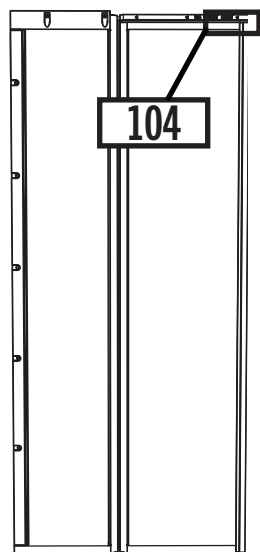

AGY (x1)

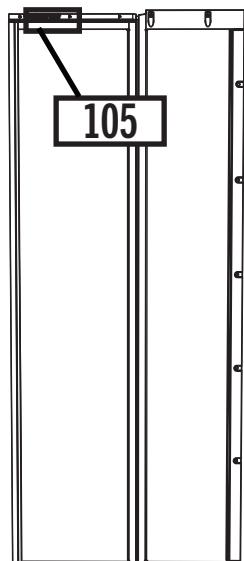

AGN (x1)

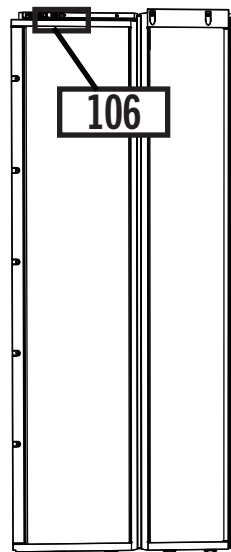

AGW (x1)

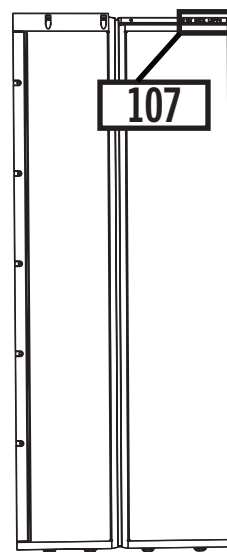

AGL (x1)

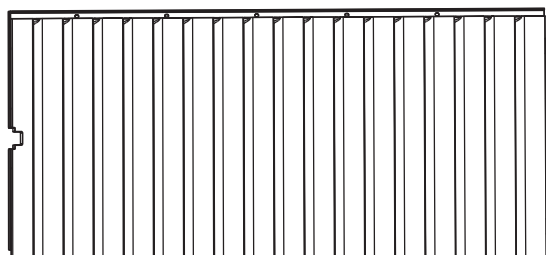

AHD (x6)

CONTENTS OF SMALL PARTS KIT / CONTENU DU KIT PETITES PIÈCES / CONTENIDO DEL KIT DE PIEZAS PEQUEÑAS

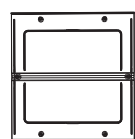

AHC (x3)

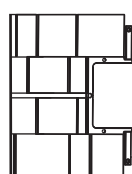

AGG (x1)

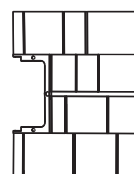

AFW (x1)

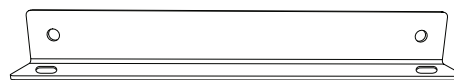

HDV (x2)



AFL (x6)



AIW (x1)

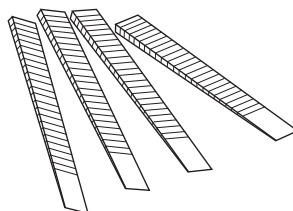

AIX (x4)

Remove this section for quick reference / Enlevez cette section pour référence rapide / Retire esta sección para referencia rápida



PARTS IDENTIFIER / IDENTIFICATEUR DE PIÈCES / IDENTIFICADOR DE PIEZAS

HARDWARE BAGS / SACS DE QUINCAILLERIE / BOLSAS DE HERRAJE



Remove this section for quick reference / Enlevez cette section pour référence rapide / Retire esta sección para referencia rápida



SECTION 7 (CONTINUED) / SECTION 7 (SUITE) / SECCIÓN 7 (CONTINUACIÓN)

TOOLS AND HARDWARE REQUIRED / OUTILS ET QUINCAILLERIE REQUIS / INSTRUMENTAL Y HERRAJE REQUERIDOS

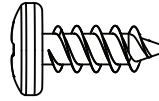

ADZ (x20)

7.2

- Top end
- Extrémité supérieure
- Extremo superior

- Insert a **wall support channel (AFM)** into the groove in the **front-right corner wall panel (AGY)** and secure using four (4) **screws (ADZ)**.
- Insérer un **support mural (AFM)** dans la rainure du **panneau mural avant droit (AGN)** et bien le fixer à l'aide de quatre (4) **vis (ADZ)**.
- Insertar un **soporte mural (AFM)** en la ranura en el **panel mural delantero derecho (AGN)** y fijarlo bien usando cuatro (4) **tornillos (ADZ)**.

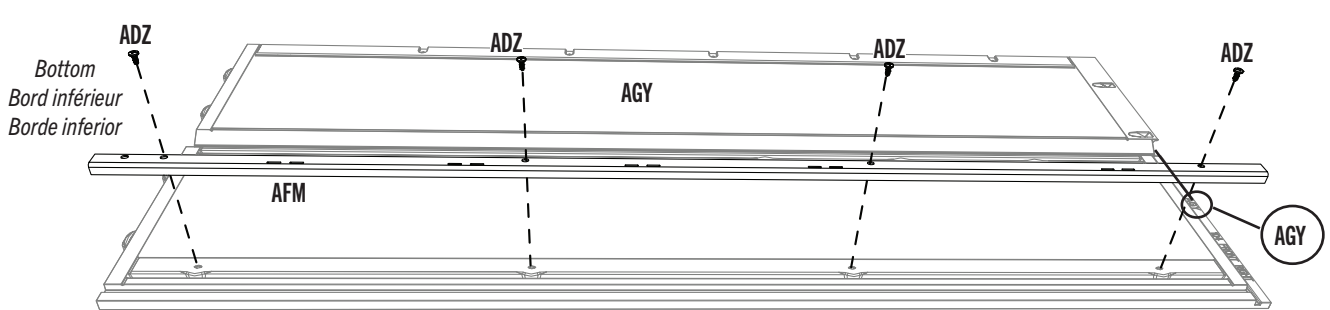

- No screw in bottom hole.
- Aucune vis dans le trou inférieur.
- Ningún tornillo en el agujero inferior.

7.3

- Top end
- Extrémité supérieure
- Extremo superior

- Secure a **wall support channel (AFM)** at the middle of the notch on four (4) **wall panels (AHD)** using four (4) **screws (ADZ)** for each. **The remaining two (2) wall panels will have the wall support channels installed in the next section.**
- Fixez un **renfort de soutien mural (AFM)** au centre de l'encoche de chacun sur quatre (4) **panneaux muraux arrière (AHD)** à l'aide de quatre (4) **vis (ADZ)**. **Les deux (2) panneaux muraux restants auront les chenaux de support muraux installés dans la section suivante.**
- Asegure un **canal soporte de pared (AFM)** en el medio de la marca en cuatro (4) **paneles de pared trasera (AHD)** utilizando cuatro (4) **tornillos (ADZ)** para cada uno. **Los canales de apoyo para la pared de los dos (2) paneles restantes se instalarán en la siguiente sección.**



- No screw in top hole.
- Aucune vis dans le trou supérieur.
- Ningún tornillo en el agujero superior.

- Notch
- Encoche
- Muesca

X4

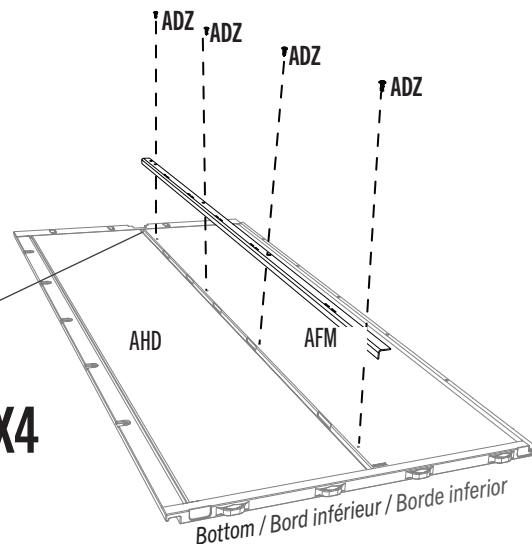

▶ SECTION 7 (CONTINUED) / SECTION 7 (SUITE) / SECCIÓN 7 (CONTINUACIÓN)

TOOLS AND HARDWARE REQUIRED / OUTILS ET QUINCAILLERIE REQUIS / INSTRUMENTAL Y HERRAJE REQUERIDOS



7.4



- Insert the two left-most tabs at the bottom of the **corner panel (AGY)** into the two right-most slots along the edge of the floor.
- Insérez les deux languettes gauches au bord inférieur du **panneau angulaire (AGY)** dans les deux rainures droites le long du bord du plancher.
- Introduzca las lengüetas al borde inferior del **panel angular (AGY)** en las ranuras a lo largo del borde del piso.

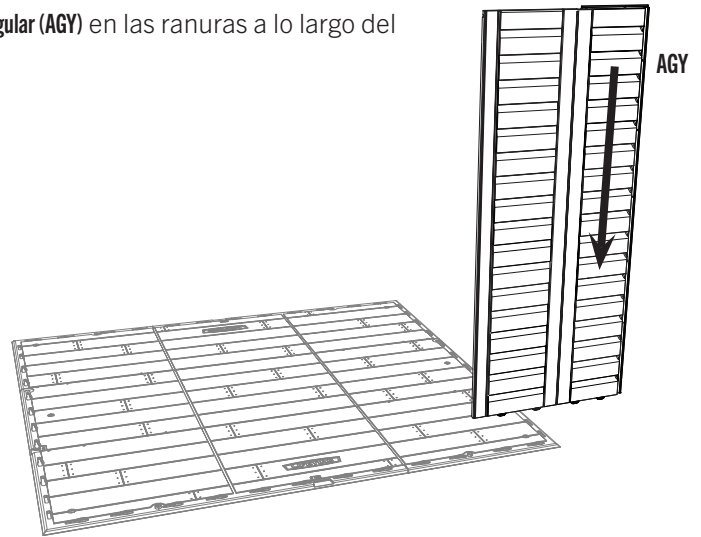

7.5

- Slide the panel to the left.
- Glissez le panneaux à gauche.
- Deslice el panel a la izquierda.



- *If the bushings are in the way, temporarily remove them to insert the wall panel.*
- *Si les bagues interfèrent avec l'installation, les retirer temporairement pour pouvoir insérer le panneau mural.*
- *Si los casquillos interfieren con la instalación, retirarlos temporalmente para poder insertar el panel mural.*

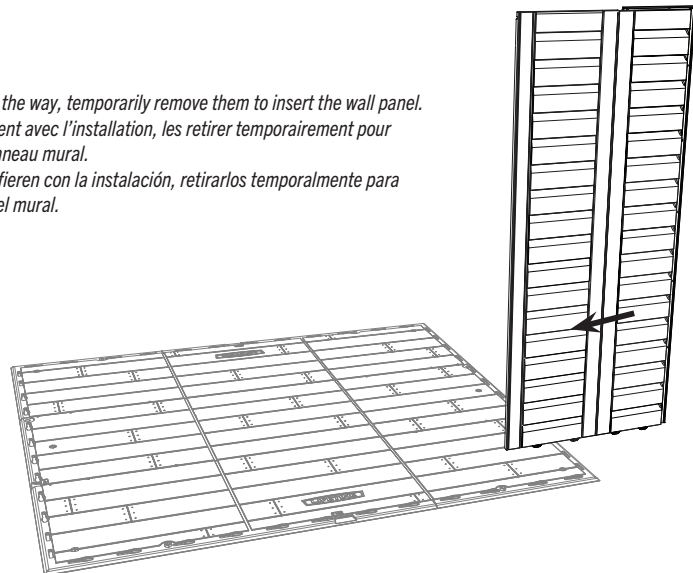

► SECTION 7 (CONTINUED) / SECTION 7 (SUITE) / SECCIÓN 7 (CONTINUACIÓN)

TOOLS AND HARDWARE REQUIRED / OUTILS ET QUINCAILLERIE REQUIS / INSTRUMENTAL Y HERRAJE REQUERIDOS

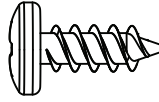

ADZ (x10)

7.6

- Bend corner panel and snap the remaining tabs in place. To help with insertion, place the **plastic block (AIW)** under the floor panel directly under the tab being inserted. You should hear a “click” when the tab pops into place. **Repeat this step for the second tab.**
- Pliez le panneau angulaire et insérez les autres languettes. Pour aider avec le montage, mettez le **bloc en plastique (AIW)** sous le panneau de plancher directement sous la languette que vous voulez insérer. **Répétez ce processus pour la deuxième languette.**
- Doble el panel angular e introduzca las lengüetas restantes. Para ayudar con el armado, deslice el **bloque de plástico (AIW)** debajo el panel de piso directamente debajo la lengüeta que quiere insertar. Se escucha un «clic» cuando la lengüeta se sienta en su lugar. **Repita este proceso para la segunda lengüeta.**



AIW (x1)

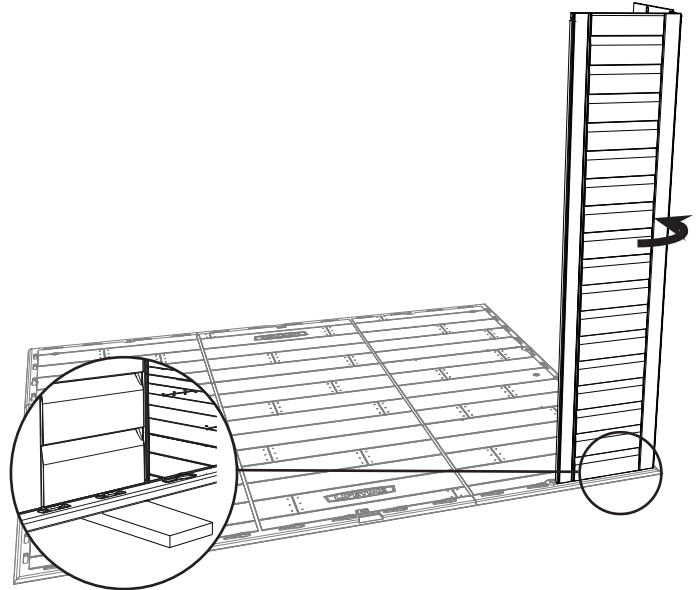

7.7

- Insert the tabs of two **wall panels (AHD)**.
- Insérez les languettes d'un **panneau mural (AHD)**.
- Inserte las lengüetas del **panel mural (AHD)**.

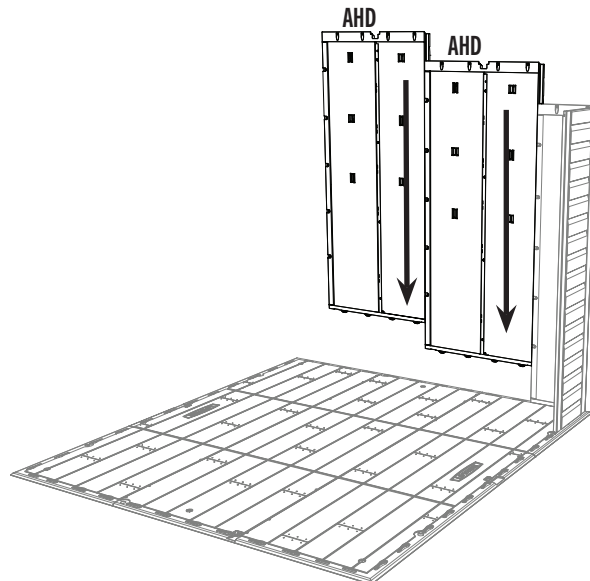

► SECTION 7 (CONTINUED) / SECTION 7 (SUITE) / SECCIÓN 7 (CONTINUACIÓN)

TOOLS AND HARDWARE REQUIRED / OUTILS ET QUINCAILLERIE REQUIS / INSTRUMENTAL Y HERRAJE REQUERIDOS

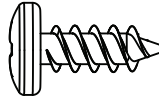

ADZ (x15)

7.8

- Secure the panels together using five (5) screws (ADZ) for each seam. **Do not overtighten the screws. The attachment points have a thin membrane that the screws will puncture.**
- Attachez les deux panneaux l'un à l'autre à l'aide des cinq (5) vis (ADZ) chaque jointure. **Ne serrez pas excessivement les vis. Les vis perforeront les membranes fines situées aux points d'attache.**
- Sujete los dos paneles el uno al otro usando cinco (5) tornillos (ADZ) cada juntura. **No apriete demasiado los tornillos. Los tornillos perforarán las membranas delgadas situadas en los puntos de conexión.**

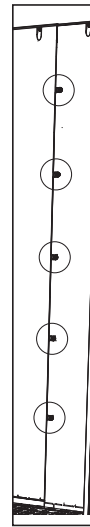

7.9

- Insert this **corner panel (AGW)** like the first corner wall panel. Secure with screws (ADZ).
- Insérez ce **panneau angulaire (AGW)** comme le premier panneau angulaire. Attache-le bien à l'aide des vis (ADZ).
- Inserte este **panel angular (AGW)** como el primer panel angular. Sujételo con **tornillos (ADZ)**.



AIW (x1)

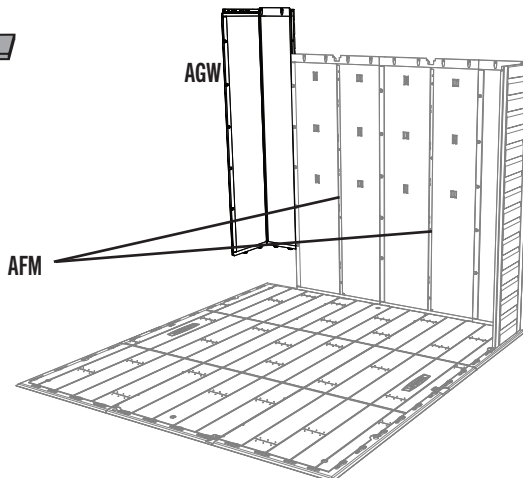

7.10

- Insert the two (2) wall panels (AHD) **WITHOUT** the wall support channels here. Secure with screws (ADZ).
- Insérer les deux (2) panneaux muraux (AHD) **SANS** les canaux de support mural ici. Attache-le bien à l'aide des vis (ADZ).
- Insertar los dos (2) paneles murales (AHD) **SIN** los canales de soporte de muros aquí. Sujételo con **tornillos (ADZ)**.

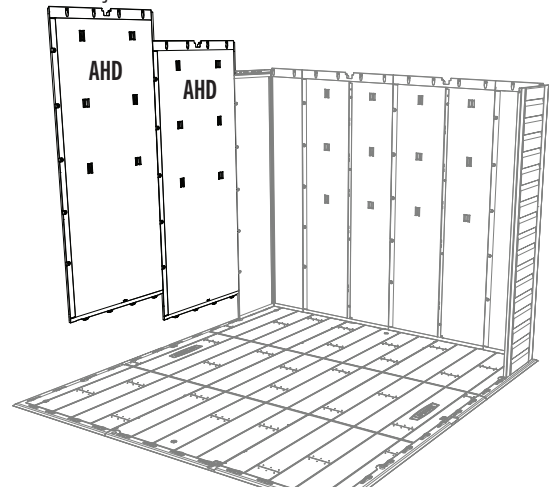

► SECTION 7 (CONTINUED) / SECTION 7 (SUITE) / SECCIÓN 7 (CONTINUACIÓN)

TOOLS AND HARDWARE REQUIRED / OUTILS ET QUINCAILLERIE REQUIS / INSTRUMENTAL Y HERRAJE REQUERIDOS

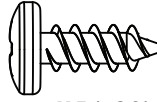

ADZ (x20)

7.11

- Insert this **corner panel (AGL)** like the first corner wall panel. Secure with **screws (ADZ)**.
- Insérez ce **panel angular (AGL)** como el primer panel angular. Sujételo con **tornillos (ADZ)**.
- Insérez ce **panneau angulaire (AGL)** comme le premier panneau angulaire. Attache-le bien à l'aide des **vis (ADZ)**.

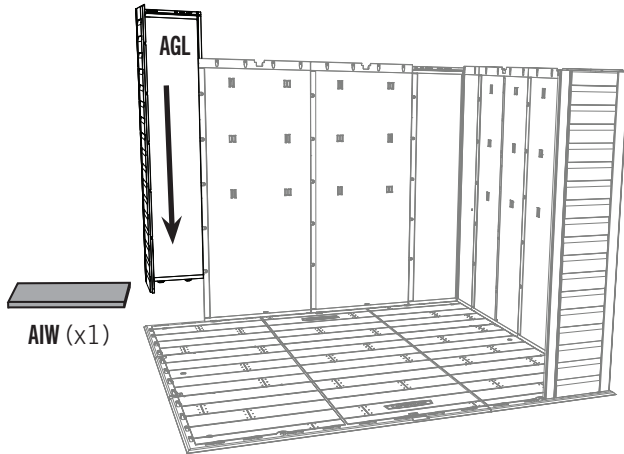

7.12

- Attach two **wall panels (AHD)** to the left side of the shed using **screws (ADZ)**.
- Sujete dos **paneles murales (AHD)** al borde izquierdo del piso usando **tornillos (ADZ)**.
- Attachez deux **panneaux muraux (AHD)** au bord gauche du plancher à l'aide des **vis (ADZ)**.

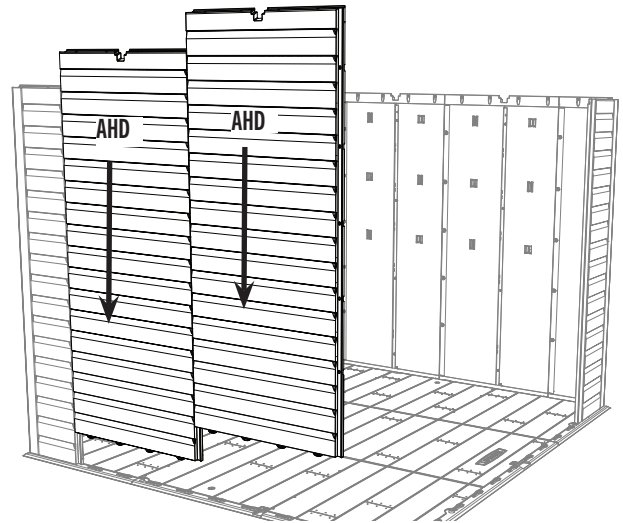

7.13

- Insert the last **corner panel (AGN)** in the same way as the previous one. Secure with **screws (ADZ)**.
- Insérez le último **panel angular (AGN)** en la misma manera que el panel angular anterior. Sujételo con **tornillos (ADZ)**.
- Insérez le dernier **panneau angulaire (AGN)** dans la même manière que le panneau angulaire précédent. Attachez-le bien à l'aide des **vis (ADZ)**.

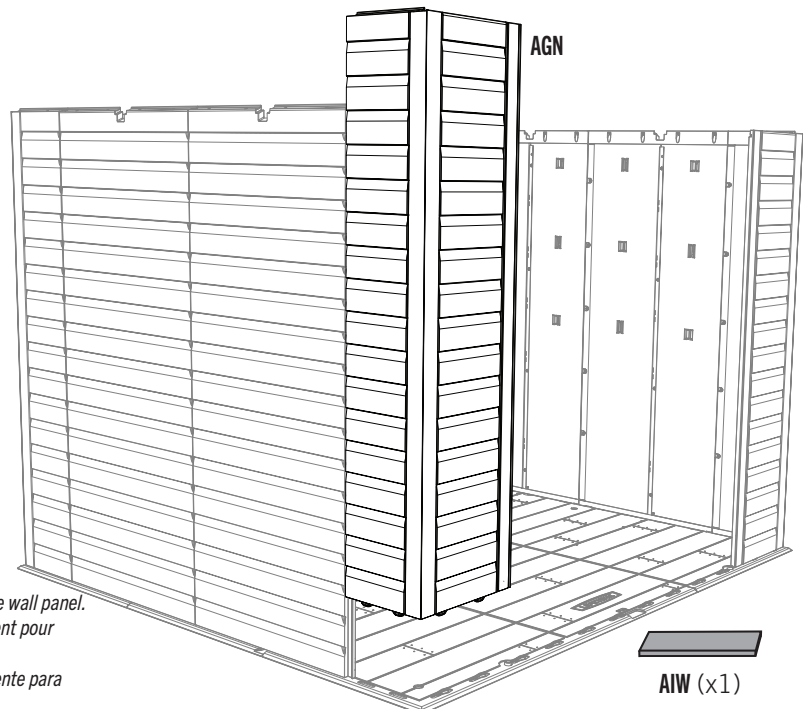

- If the **bushings** are in the way, temporarily remove them to insert the wall panel.
- Si les **bagues** interfèrent avec l'installation, les retirer temporairement pour pouvoir insérer le panneau mural.
- Si los **casquillos** interfieren con la instalación, retirarlos temporalmente para poder insertar el panel mural.

8

SHELVING INSTALLATION / INSTALLATION DU RAYONNAGE / INSTALACIÓN DE LA ESTANERÍA



HARDWARE REQUIRED / QUINCAILLERIE REQUISE / HERRAJE REQUERIDO

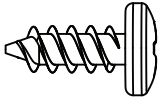

ADZ (x16)

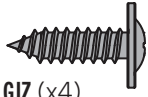

GJZ (x4)

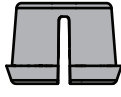

FEX (x4)

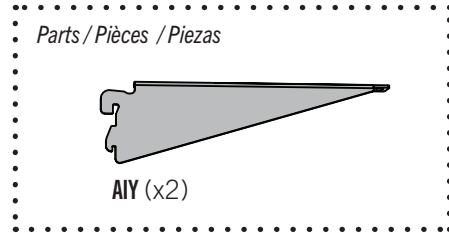

PARTS REQUIRED / PIÈCES REQUISES / PIEZAS REQUERIDAS

Metal parts / Pièces en métal / Piezas de metal

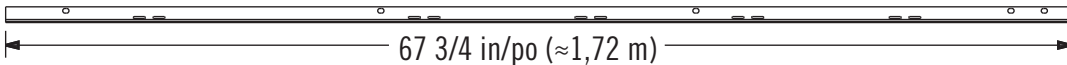

AFM (x2)

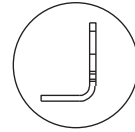

HDU (x1)

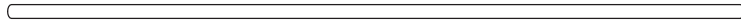

HDT (x1)

CONTENTS OF SMALL PARTS BOX / CONTENU DE LA BOÎTE DE PETITES PIÈCES / CONTENIDO DE LA CAJA DE PIEZAS PEQUEÑAS

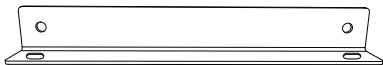

HDV (x2)

Plastic parts / Pièces en plastique / Piezas de plástico

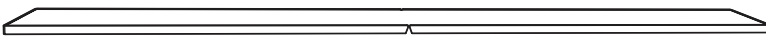

AFV (x1)



TOOLS REQUIRED / OUTILS REQUIS / INSTRUMENTAL REQUERIDO

(Not included—unless otherwise indicated*) / (Non inclus — sauf indication contraire*) / (No incluido, salvo indicación contraria*)



► SECTION 8 (CONTINUED) / SECTION 8 (SUITE) / SECCIÓN 8 (CONTINUACIÓN)

TOOLS AND HARDWARE REQUIRED / OUTILS ET QUINCAILLERIE REQUIS / INSTRUMENTAL Y HERRAJE REQUERIDOS

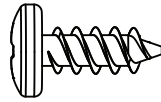

ADZ (x8)



- In case of any trouble with this section, scan the QR code below to view a video on its assembly.
- En cas de problème avec cette section, scanner le QR code en dessous pour voir une vidéo de l'assemblage.
- En caso de problemas con esta sección, escanear el código QR debajo para ver un video del ensamblaje.



<http://go.lifetime.com/8x7.5-section8>

8.1

- The right **wall/shelf support channel (AFM)** goes in the slot directly under the notch in the wall panel. The left wall support channel goes in the slot to the right of the notch in the wall panel.
- Le **canal de support du mur/étagère (AFM)** droit s'attache dans la rainure directement sous l'encoche dans le panneau mural. Le canal de support du mur/étagère gauche s'attache dans la rainure à la droite de l'encoche du panneau mural.
- El **canal de soporte para la pared/estante (AFM)** derecho se sujeta dentro de la ranura directamente debajo la muesca en el panel de pared. El canal de soporte para la pared izquierdo se sujeta dentro de la ranura a la derecha de la muesca en el panel de pared.

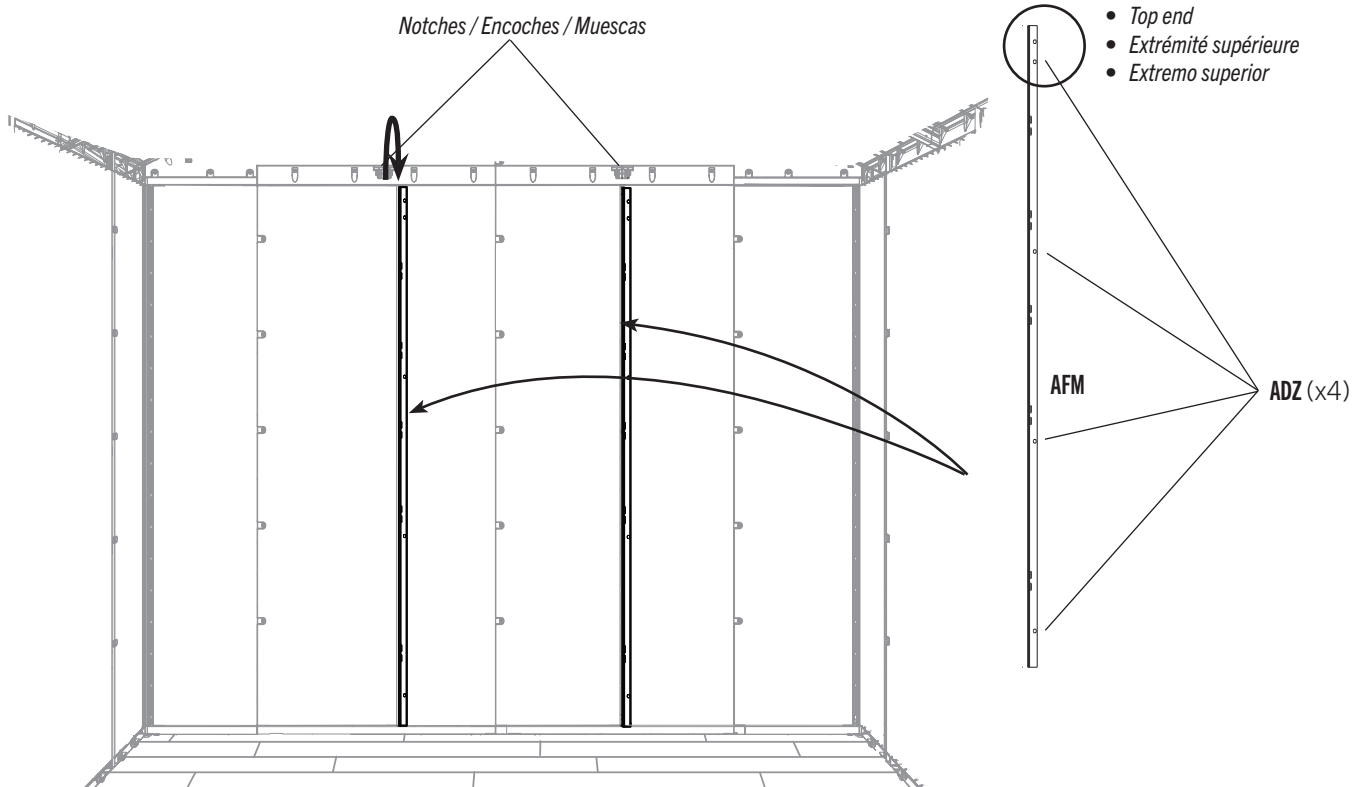

► SECTION 8 (CONTINUED) / SECTION 8 (SUITE) / SECCIÓN 8 (CONTINUACIÓN)

TOOLS AND HARDWARE REQUIRED / OUTILS ET QUINCAILLERIE REQUIS / INSTRUMENTAL Y HERRAJE REQUERIDOS

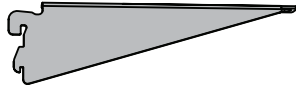

AIY (x2)

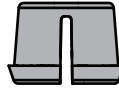

FEX (x4)

8.2

- Insert the **shelf brackets (AIY)** into the slots in the wall/shelf support channels. **The brackets must be at the same height.**
- Insérer les **équerres (AIY)** dans les fentes dans les cannaux de support pour les murs/étagères. **Les équerres doivent être à la même hauteur.**
- Insertar las **escuadras (AIY)** en las ranuras en los canales de soporte para las paredes/estantes. **Las escuadras deben estar a la misma altura.**

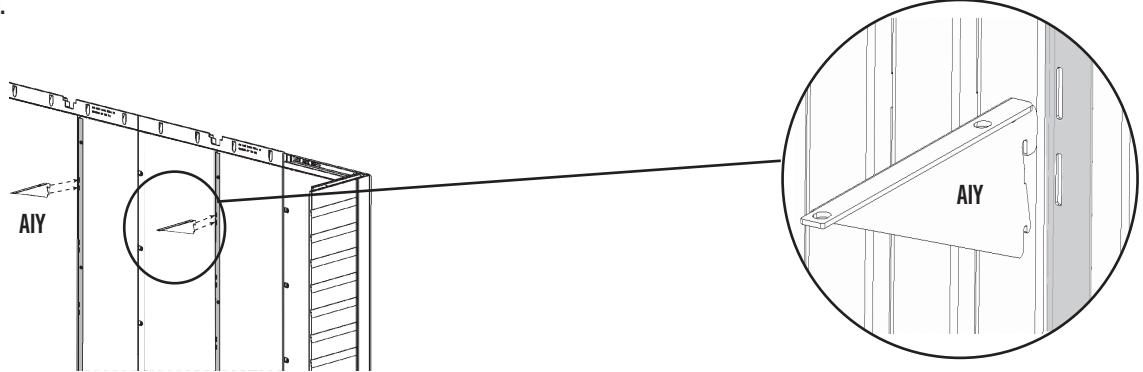

8.3

- Place **screw anchors (FEX)** into the side walls at the same level the shelf braces were placed.
- Placez les **vis d'ancrage (FEX)** dans les murs de côté à la même hauteur que vous avez placé les renforts de l'étagère.
- Coloque los **anclajes de tornillo (FEX)** en las paredes laterales al mismo nivel en el que se colocaron los soportes del estante.

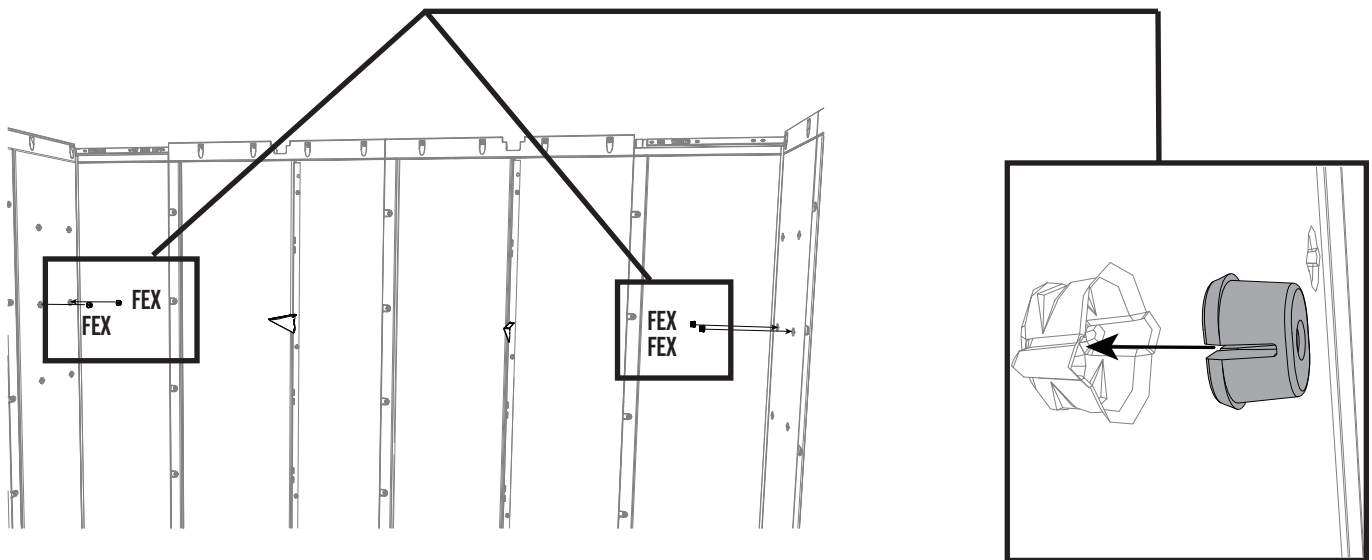

► SECTION 8 (CONTINUED) / SECTION 8 (SUITE) / SECCIÓN 8 (CONTINUACIÓN)

TOOLS AND HARDWARE REQUIRED / OUTILS ET QUINCAILLERIE REQUIS / INSTRUMENTAL Y HERRAJE REQUERIDOS

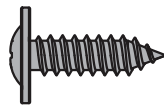

GJZ (x4)

8.4

- Attach a **shelf support bracket (HDV)** into the side wall at the same level the shelf braces were placed. Repeat for the other shelf support bracket on the opposite side.
- Placez le **support de l'étagère (HDV)** dans le mur de côté à la même hauteur que vous avez placé les renforts de l'étagère. Répétez pour le support de l'étagère de l'autre côté.
- Fije un **soporte de estante (HDV)** en la pared lateral al mismo nivel en el que se colocaron los soportes del estante. Repita para el otro soporte de estante en el lado opuesto.

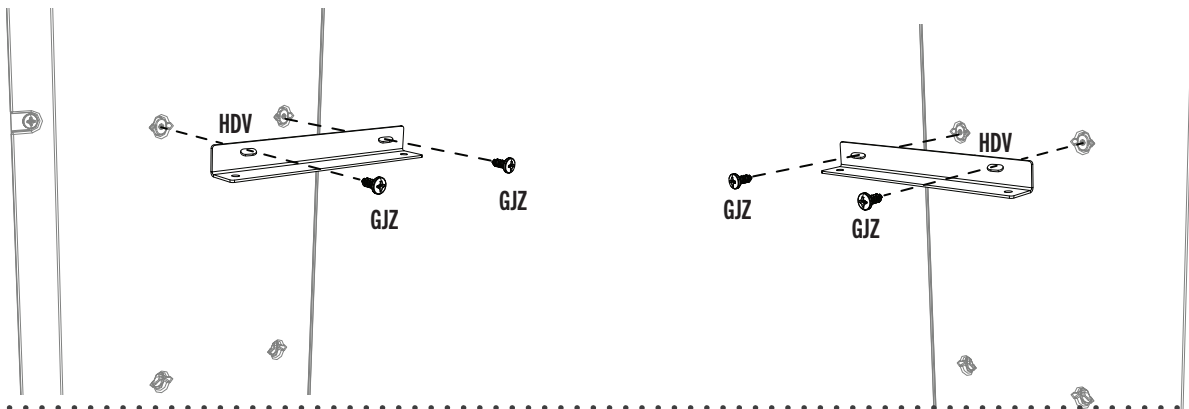

8.5

- Unfold the shelf before installing.
- Dépliez l'étagère avant l'installation.
- Despliegue el estante antes de instalar.

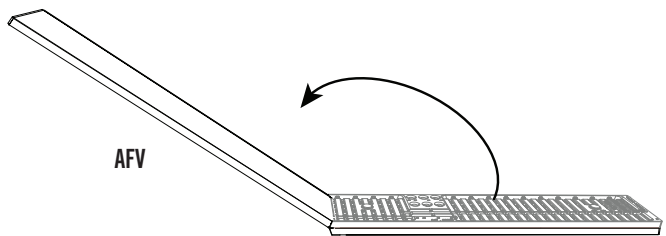

8.6

- Snap the **short and long shelf support tubes (HDT and HDU)** into the underside of the shelf. The long shelf support tube should be put in place near the side labelled "Front".
- Clipsez les **tubes d'appui long et court de l'étagère (HDT et HDU)** sous l'étagère. Le tube d'appui long doit être mis en place près du côté marqué « Devant ».
- Conecte a presión los **tubos de soporte del estante corto y largo (HDT y HDU)** en la parte inferior del estante. El tubo de soporte largo del estante debería ponerse en su lugar cerca del lado etiquetado "Front".

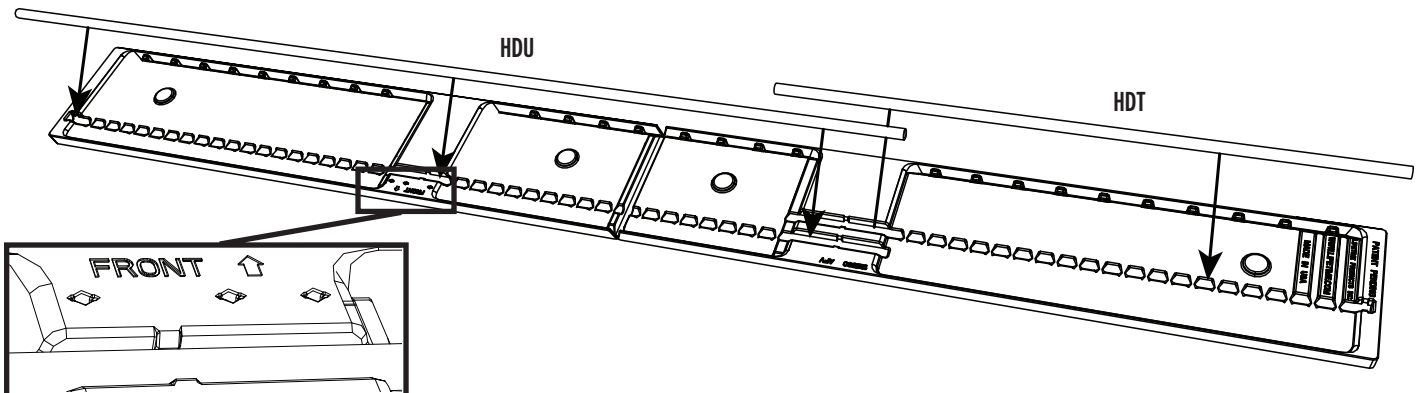

► SECTION 8 (CONTINUED) / SECTION 8 (SUITE) / SECCIÓN 8 (CONTINUACIÓN)

TOOLS AND HARDWARE REQUIRED / OUTILS ET QUINCAILLERIE REQUIS / INSTRUMENTAL Y HERRAJE REQUERIDOS

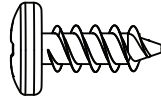

ADZ (x8)

8.7

- Attach the **shelf (AFV)** to the corner wall panels and shelf support brackets using eight (8) **screws (ADZ)**.
- Attachez l'**étagère (AFV)** aux panneaux de mur de coin et aux supports de l'étagère à l'aide de huit (8) **vis (ADZ)**.
- Fije el **estante (AFV)** a los paneles de pared de esquina y a los soportes del estante usando ocho (8) **tornillos (ADZ)**.

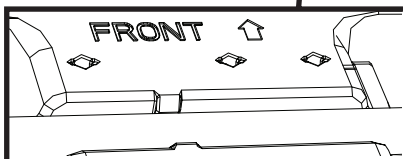
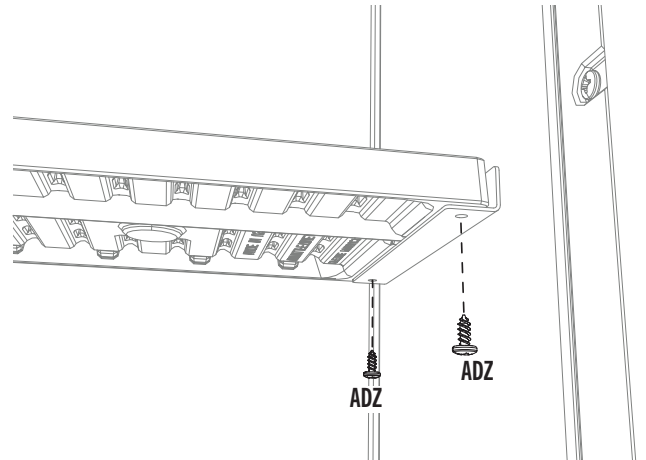
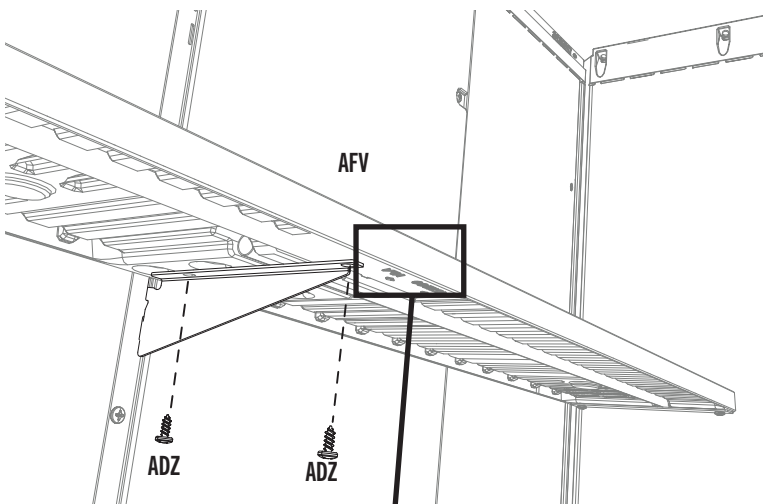
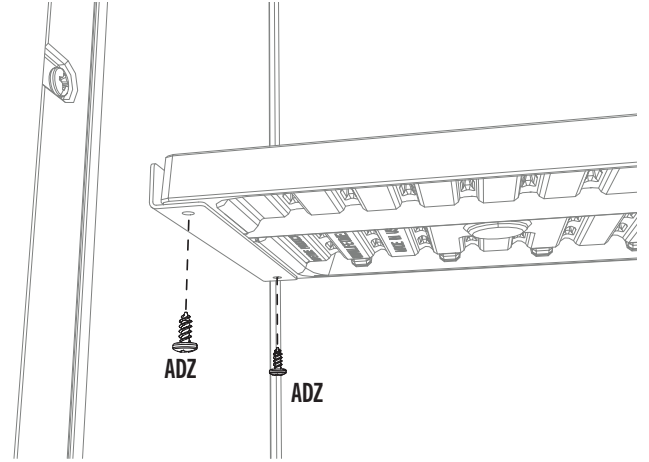
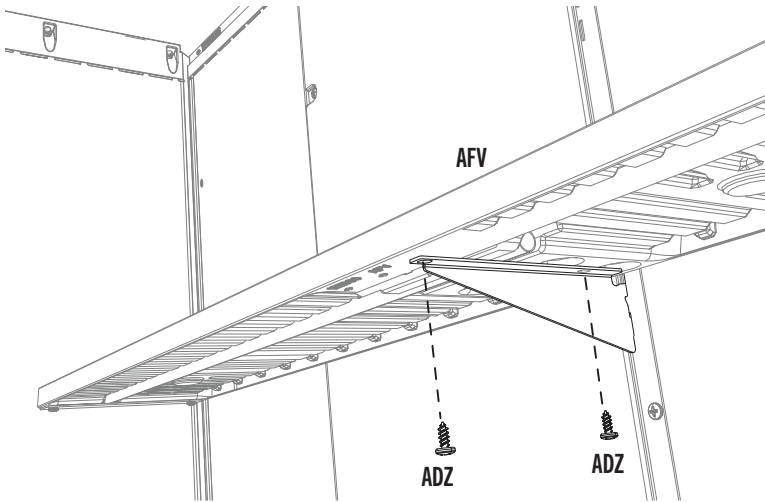

9

DOOR & ENTRY GABLE INSTALLATION / INSTALLATION DU PIGNON D'ENTRÉE ET DES PORTES / INSTALACIÓN DE LA FACHADA DE ENTRADA Y LAS PUERTAS



HARDWARE REQUIRED / QUINCAILLERIE REQUISE / HERRAJE REQUERIDO

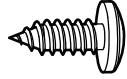

ADX (x4)



AHP (x2)

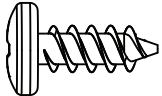

ADZ (x6)

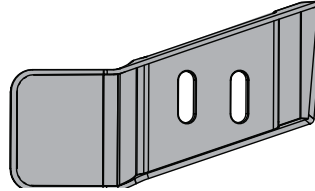

AIM (x1)

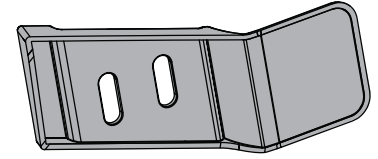

AIC (x1)



PARTS REQUIRED / PIÈCES REQUISES / PIEZAS REQUERIDAS

Plastic parts / Pièces en plastique / Piezas de plástico

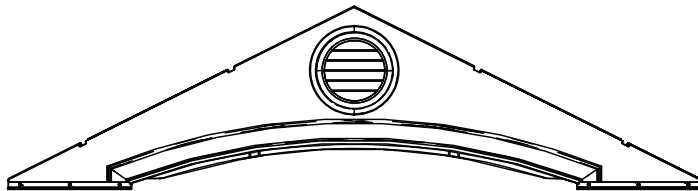

(x1)

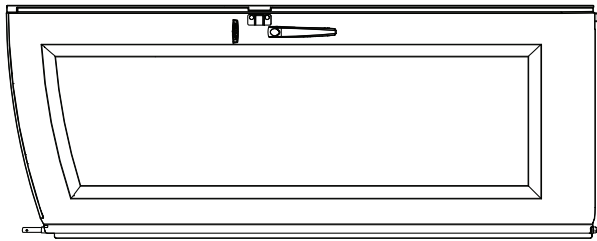

(x1)

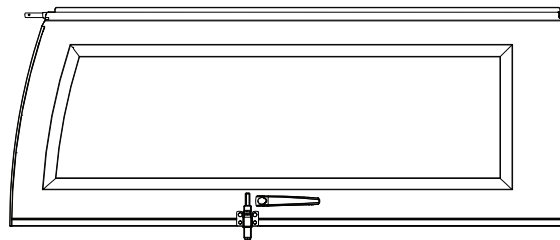

(x1)



TOOLS REQUIRED / OUTILS REQUIS / INSTRUMENTAL REQUERIDO

(Not included—unless otherwise indicated*) / (Non inclus — sauf indication contraire*) / (No incluido, salvo indicación contraria*)

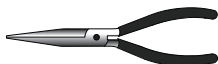

► SECTION 9 (CONTINUED) / SECTION 9 (SUITE) / SECCIÓN 9 (CONTINUACIÓN)

TOOLS AND HARDWARE REQUIRED / OUTILS ET QUINCAILLERIE REQUIS / INSTRUMENTAL Y HERRAJE REQUERIDOS



AHP (x2)



- In case of any trouble with this section, scan the QR code below to view a video on its assembly.
- En cas de problème avec cette section, scanner le QR code en dessous pour voir une vidéo de l'assemblage.
- En caso de problemas con esta sección, escanear el código QR debajo para ver un video del ensamblaje.



<http://go.lifetime.com/8x7.5-section9>

9.1



- Pull the hinge tube down out of the door about six inches. Align the hole at the bottom of the hinge tube with the slit in the bushing, and insert the tube. Insert a **cotter pin (AHP)** and bend the ends.
- Éteignez le tube d'articulation à peu près quinze centimètres du bord inférieur de la porte. Alignez le trou dans la partie inférieure du tube avec la fente dans la bague, et insérez le tube. Insérez une **clavette (AHP)** et pliez les extrémités.
- Extienda el tubo de articulación unos quince centímetros del borde inferior de la puerta. Alinee el agujero en la parte inferior del tubo con la rendija en el casquillo, e inserte el tubo. Inserte una **clavija (AHP)** y doble los extremos.

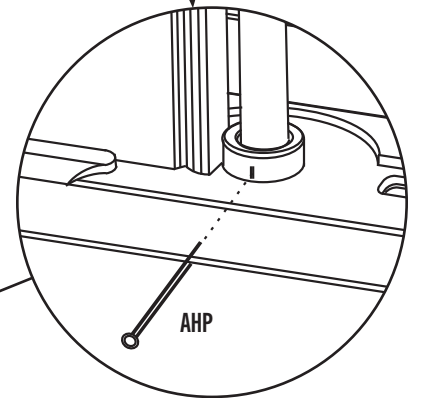
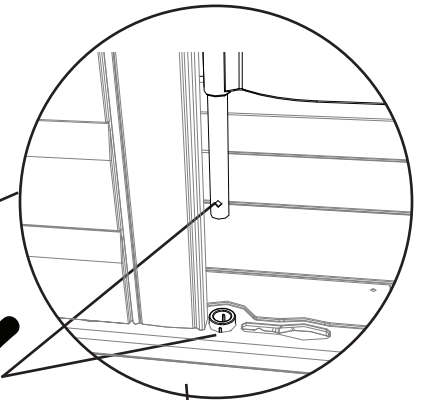
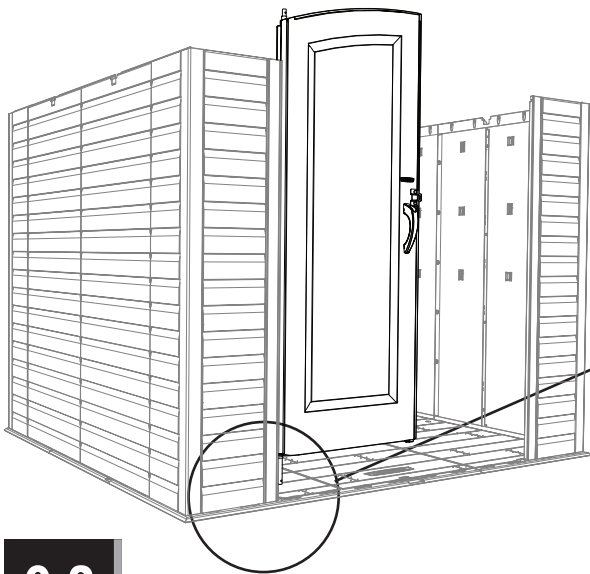

9.2



- Repeat this step for the right door.
- Répétez cette étape pour la porte droite.
- Repita este paso para la puerta derecha.

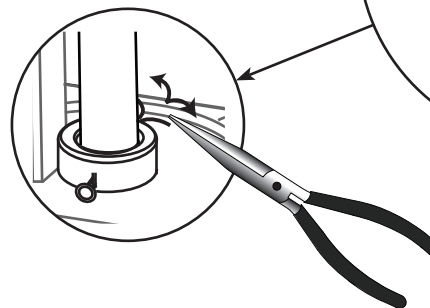
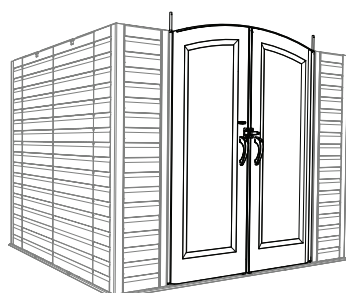

► SECTION 9 (CONTINUED) / SECTION 9 (SUITE) / SECCIÓN 9 (CONTINUACIÓN)

TOOLS AND HARDWARE REQUIRED / OUTILS ET QUINCAILLERIE REQUIS / INSTRUMENTAL Y HERRAJE REQUERIDOS

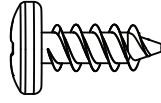

ADZ (x6)

9.3

- Slide the holes in the entry gable down over the two hinge tubes.
- Glissez les trous dans le toit à pignon d'entrée sur les deux tubes.
- Deslice los agujeros en la fachada de entrada sobre los dos tubos.

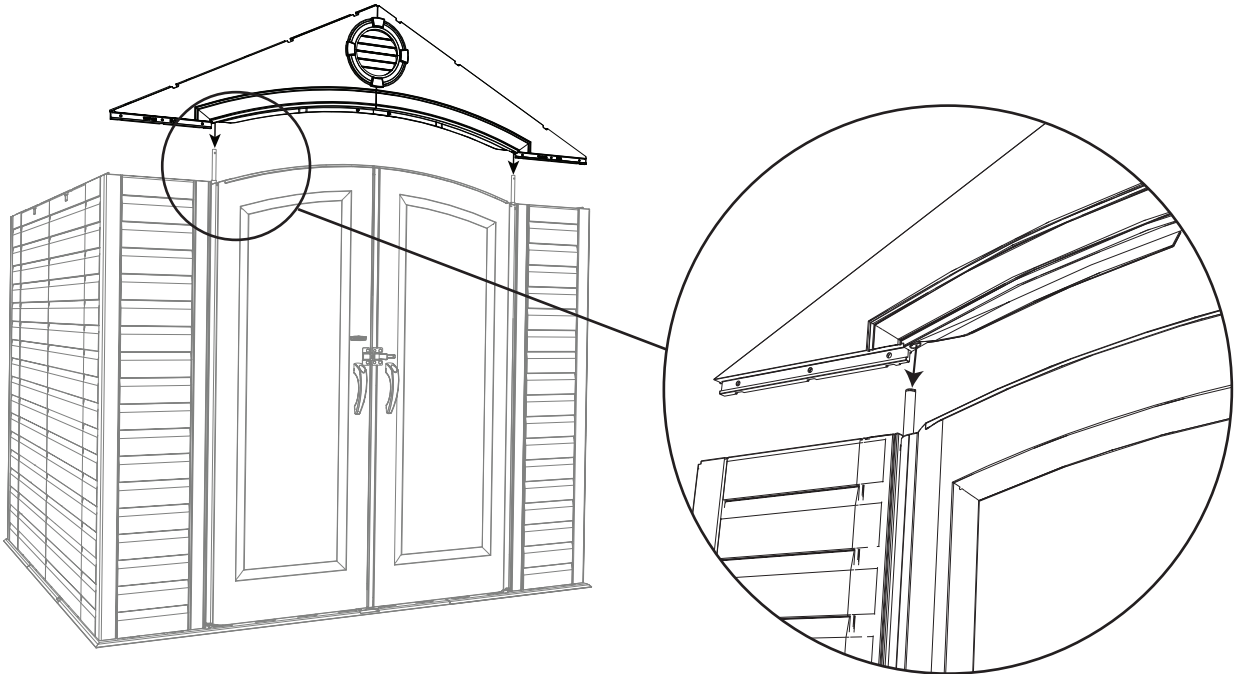

9.4

- Secure the entry gable to the shed using six (6) screws (ADZ).
- Attachez le toit à pignon d'entrée à l'abri à l'aide de six (6) vis (ADZ).
- Sujete la fachada de entrada a la caseta usando seis (6) tornillos (ADZ).

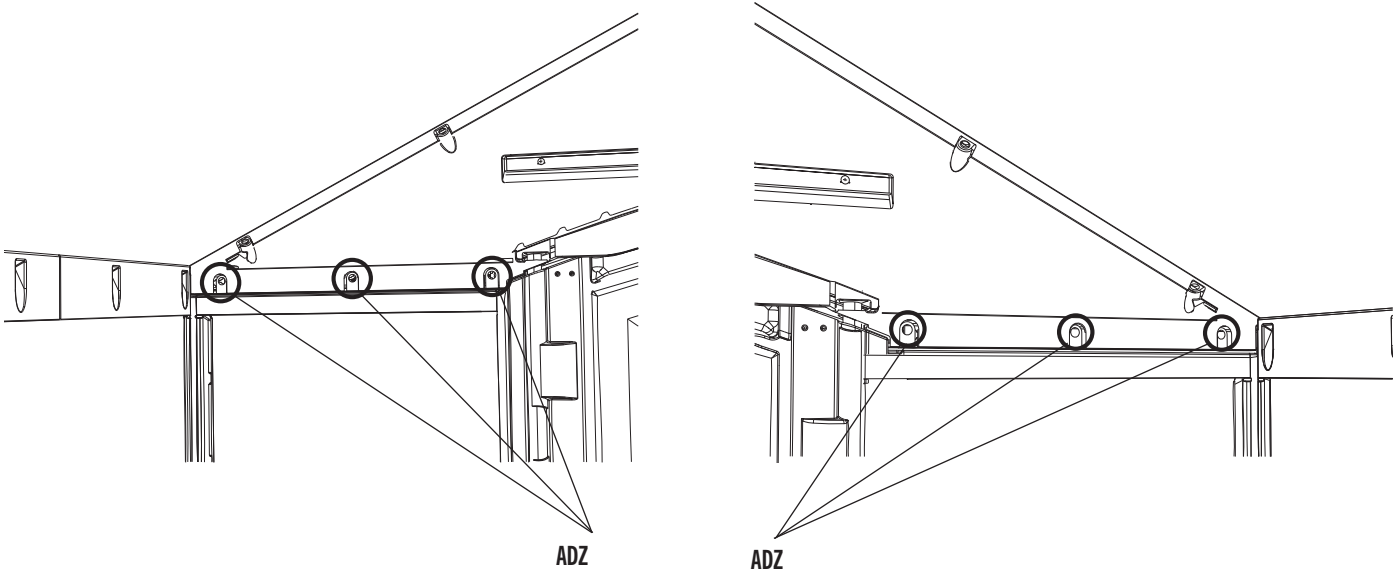

► SECTION 9 (CONTINUED) / SECTION 9 (SUITE) / SECCIÓN 9 (CONTINUACIÓN)

TOOLS AND HARDWARE REQUIRED / OUTILS ET QUINCAILLERIE REQUIS / INSTRUMENTAL Y HERRAJE REQUERIDOS

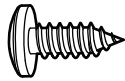

ADX (x4)

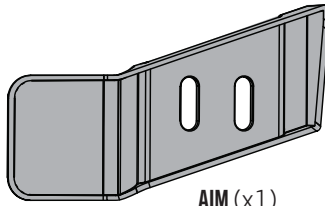

AIM (x1)

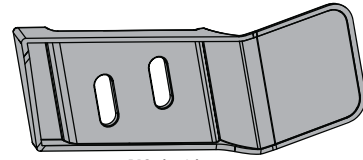

AIC (x1)

9.5

- Attach the **left (AIC)** and **right (AIM)** gap flaps to the corners of the doors using the hardware included. **These flaps simply serve to block out light.**
- Attachez les **rabats gauche (AIC)** et **droit (AIM)** aux portes à l'aide de la quincaillerie incluse. **Ces rabats ne servent que pour empêcher la lumière d'entrer.**
- Sujete las **tapas de las puertas izquierda (AIC)** y **derecha (AIM)** a las puertas usando el herraje incluido. **Estas tapas sirven sólo para tapar la luz.**

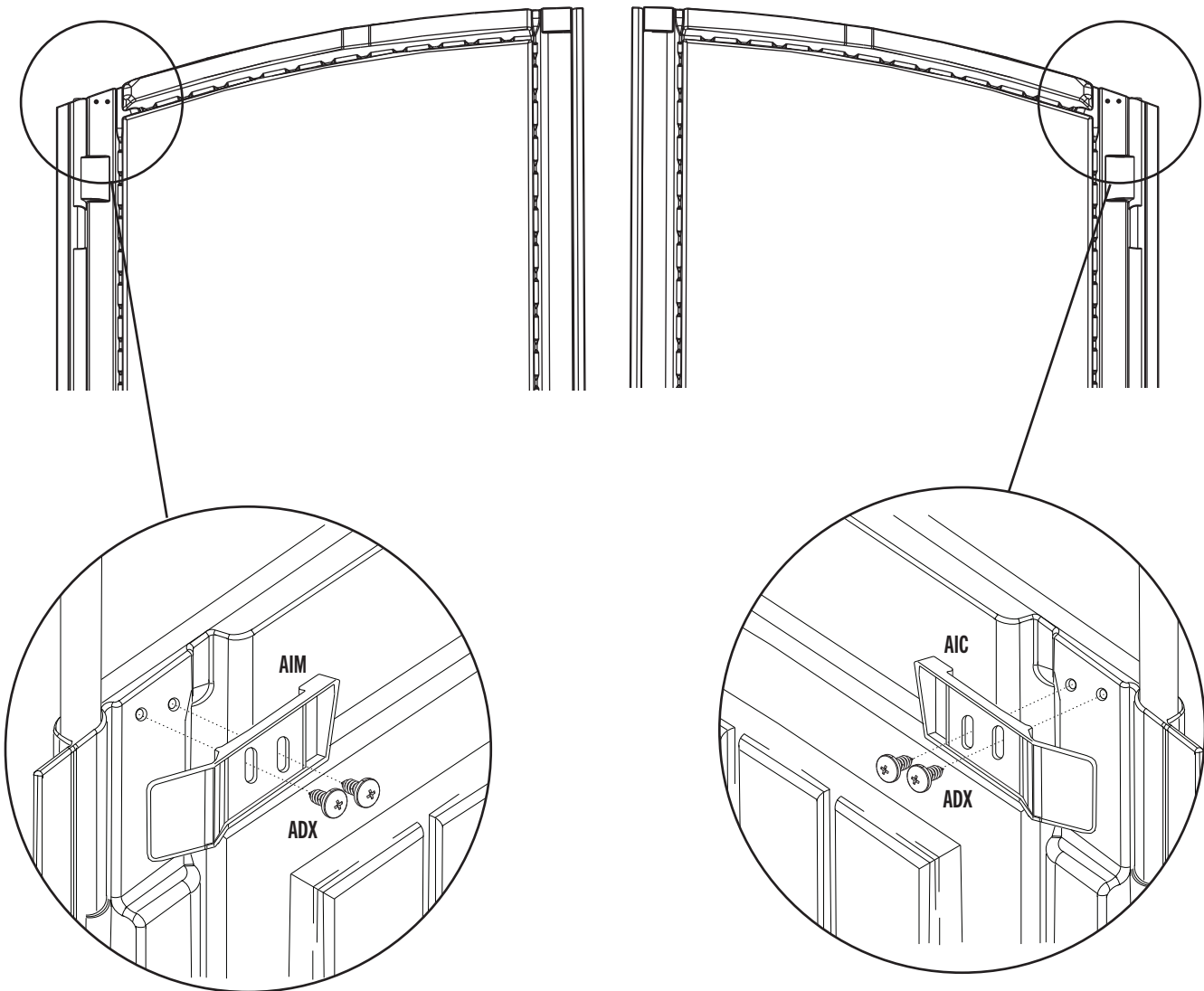



HARDWARE REQUIRED / QUINCAILLERIE REQUISE / HERRAJE REQUERIDO

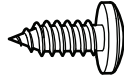

ADX (x18)

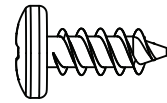

ADZ (x100)

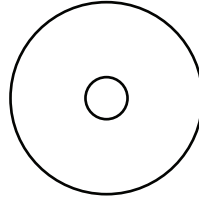

AED (x18)

Parts / Pièces / Piezas

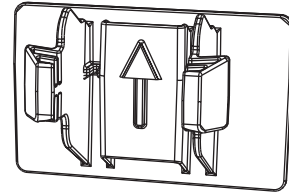

AXX (x2)



PARTS REQUIRED / PIÈCES REQUISES / PIEZAS REQUERIDAS

Metal parts / Pièces en métal / Piezas de metal



AFL (x6)

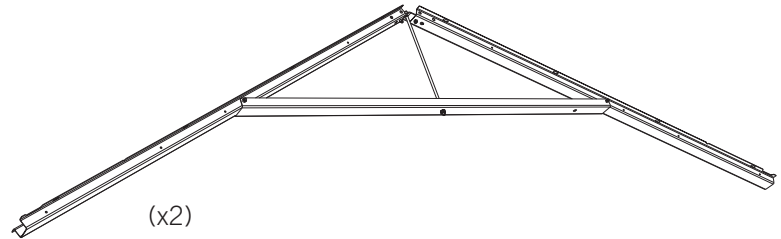

Plastic parts / Pièces en plastique / Piezas de plástico

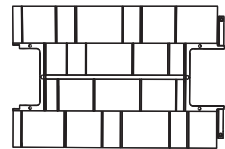

AFY (x2)

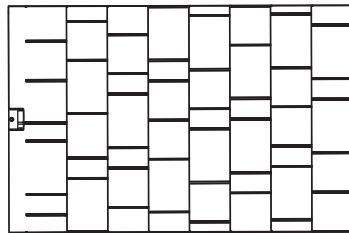

AGQ (x6)

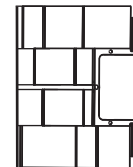

AGG (x1)

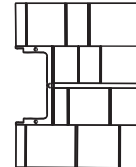

AFW (x1)

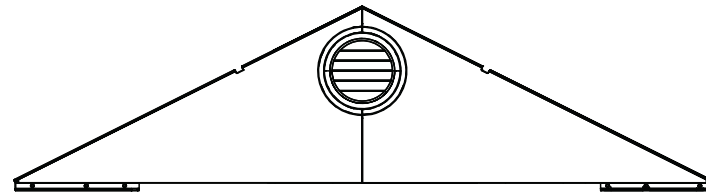

(x1)

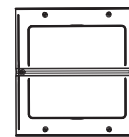

AHC (x3)



TOOLS REQUIRED / OUTILS REQUIS / INSTRUMENTAL REQUERIDO

(Not included—unless otherwise indicated*) / (Non inclus — sauf indication contraire*) / (No incluido, salvo indicación contraria*)



► SECTION 10 (CONTINUED) / SECTION 10 (SUITE) / SECCIÓN 10 (CONTINUACIÓN)

TOOLS AND HARDWARE REQUIRED / OUTILS ET QUINCAILLERIE REQUIS / INSTRUMENTAL Y HERRAJE REQUERIDOS



- In case of any trouble with this section, scan the QR code below to view a video on its assembly.
- En cas de problème avec cette section, scanner le QR code en dessous pour voir une vidéo de l'assemblage.
- En caso de problemas con esta sección, escanear el código QR debajo para ver un video del ensamblaje.



<http://go.lifetime.com/8x7.5-section10>

10.1



- Set a truss assembly into the notches on the first two opposite wall panels. Set a **roof panel (AGQ)** onto the gable, wall panel, and truss assembly. **While another adult holds this in place, continue to the next step.**
- Mettez une ferme dans les encoches des premiers deux panneaux muraux opposés. Mettez un **panneaux de toit (AGQ)** sur le pignon, panneau mural, et la ferme. **Pendant qu'un autre adulte soutient la ferme en place, continuer à la prochaine étape.**
- Coloque una cercha dentro de las muescas de los primeros dos paneles de pared opuestos. Coloque un **panel de tejado (AGQ)** sobre la fachada de entrada, panel mural, y la cercha. **Mientras que otro adulto mantenga la cercha en su lugar, seguir al próximo paso.**

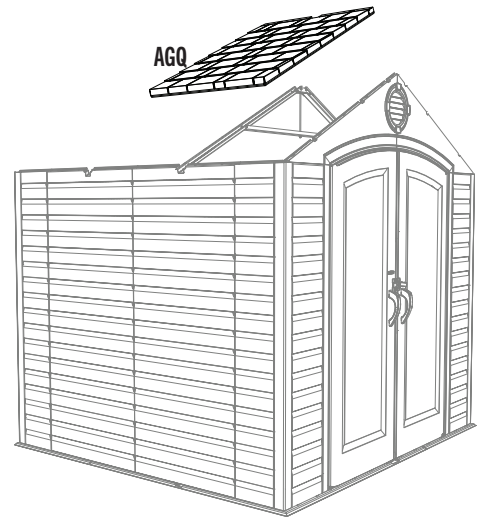
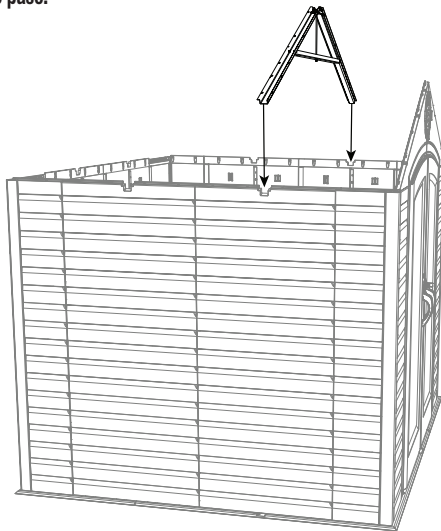

► SECTION 10 (CONTINUED) / SECTION 10 (SUITE) / SECCIÓN 10 (CONTINUACIÓN)

TOOLS AND HARDWARE REQUIRED / OUTILS ET QUINCAILLERIE REQUIS / INSTRUMENTAL Y HERRAJE REQUERIDOS

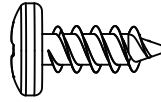

ADZ (x4)

10.2

- The groove at the bottom of the roof panel sets over the top of the wall panel. Ensure the alignment nub fits into the notch in the truss.
- Mettez la rainure au bord inférieur du panneau de toit sur la partie supérieure du panneau mural. Mettez la petite bosse d'alignement dans l'encoche de la ferme.
- Coloque la ranura a lo largo del borde inferior del panel de tejado sobre la parte superior del Panel de pared. Encaje el bulto de alineamiento en la muesca en la cercha.

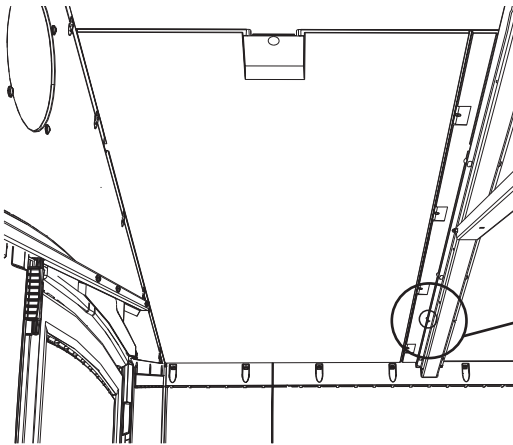

10.3

- Align the four holes in the wall panel with those at the bottom of the roof panel, and insert four (4) screws (ADZ) to secure the panel in place.
- Alignez les quatre trous dans le panneau mural avec ceux au bord inférieur du panneau de toit, et insérez quatre (4) vis (ADZ) pour attacher le panneau en place.
- Alinee los cuatro agujeros en el panel de pared con los al borde inferior del panel de tejado, e introduzca cuatro (4) tornillos (ADZ) para sujetarlo en su lugar.

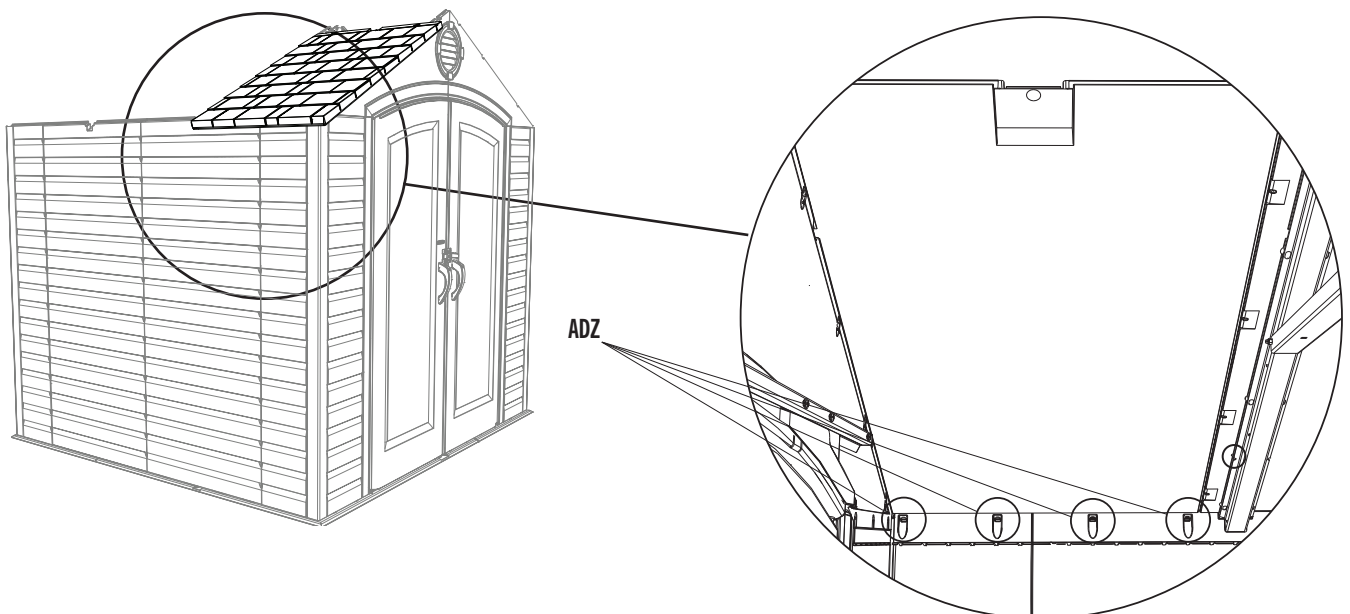

► SECTION 10 (CONTINUED) / SECTION 10 (SUITE) / SECCIÓN 10 (CONTINUACIÓN)

TOOLS AND HARDWARE REQUIRED / OUTILS ET QUINCAILLERIE REQUIS / INSTRUMENTAL Y HERRAJE REQUERIDOS

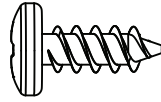

ADZ (x2)

10.4

- Insert the first two **screws (ADZ)** through the gable and into the roof panel at the locations shown. Insert the **roof support (AFL)** into the notches in the gable and between the truss and the roof panel.
- Insérez les premières deux **vis (ADZ)** à travers le pignon et dans le panneau de toit aux emplacements illustrés. Mettez le **support de toit (AFL)** dans les encoches dans le pignon et entre le panneau de toit et la ferme.
- Introduzca los primeros dos **tornillos (ADZ)** por el faldón y dentro del panel de tejado a las ubicaciones ilustrados. Inserte el **sopORTE de tejado (AFL)** en las muescas en el faldón y entre la cercha y el panel de tejado.

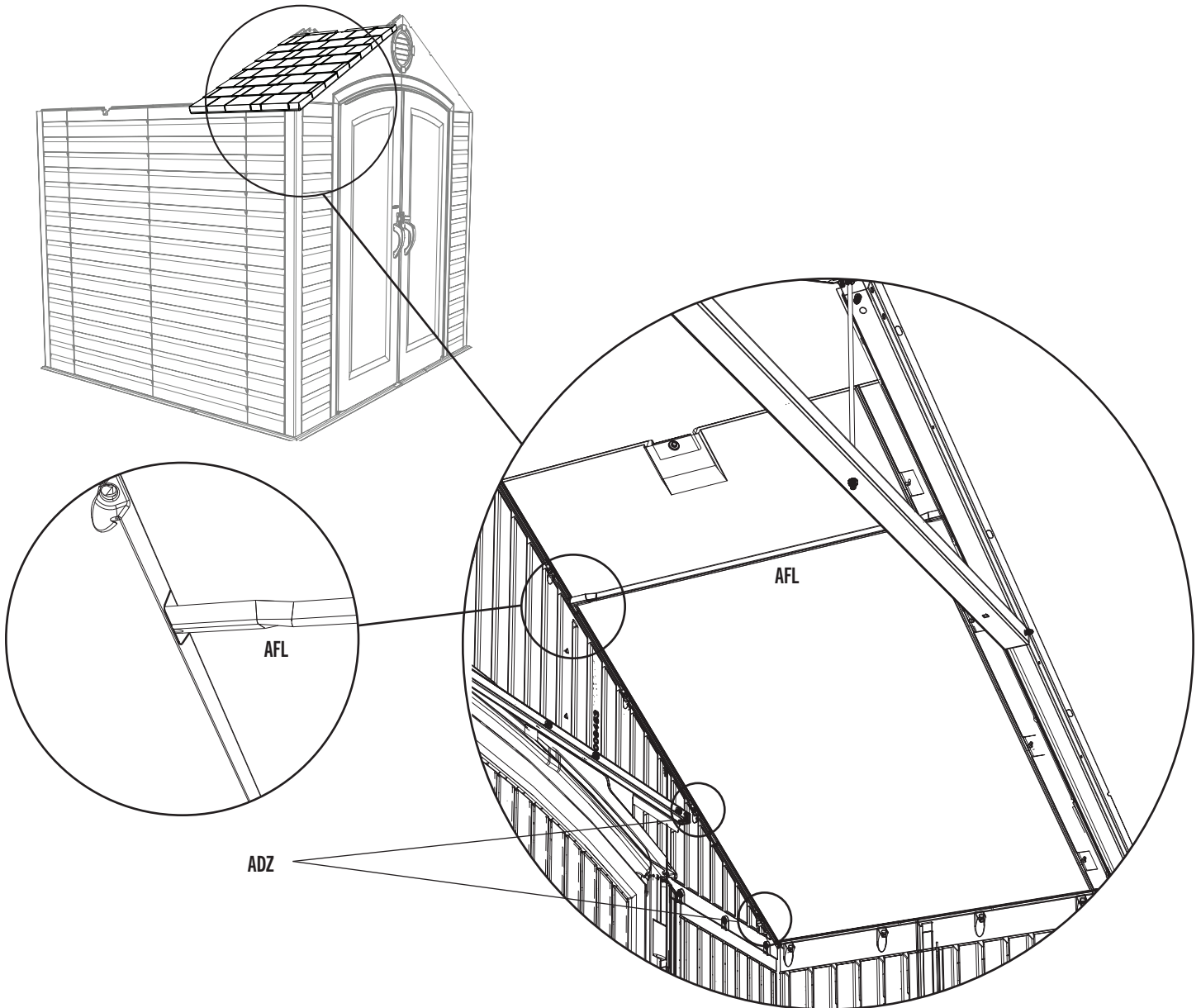

► SECTION 10 (CONTINUED) / SECTION 10 (SUITE) / SECCIÓN 10 (CONTINUACIÓN)

TOOLS AND HARDWARE REQUIRED / OUTILS ET QUINCAILLERIE REQUIS / INSTRUMENTAL Y HERRAJE REQUERIDOS

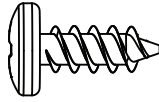

ADZ (x16)

10.5

- Insert five (5) more screws (ADZ) to secure the panel in place.
- Insérez cinq (5) autres vis (ADZ) pour attacher le panneau en place.
- Introduzca cinco (5) tornillos (ADZ) más para sujetar el panel en su lugar.

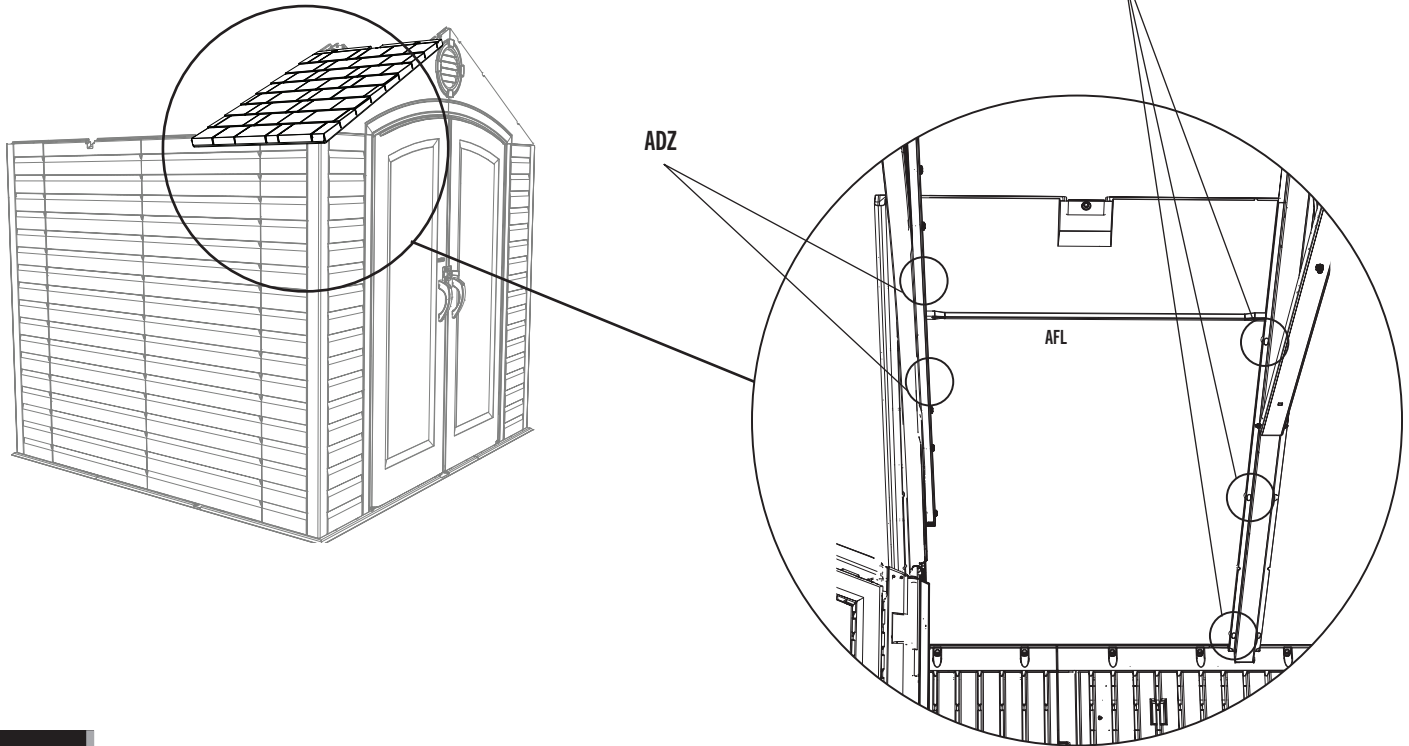

10.6



- Repeat steps 10.2–10.5 for the second front roof panel.
- Répétez les étapes 10.2 – 10.5 pour le deuxième panneau de toit avant.
- Repita los pasos 10.2–10.5 para el segundo panel de tejado delantero.

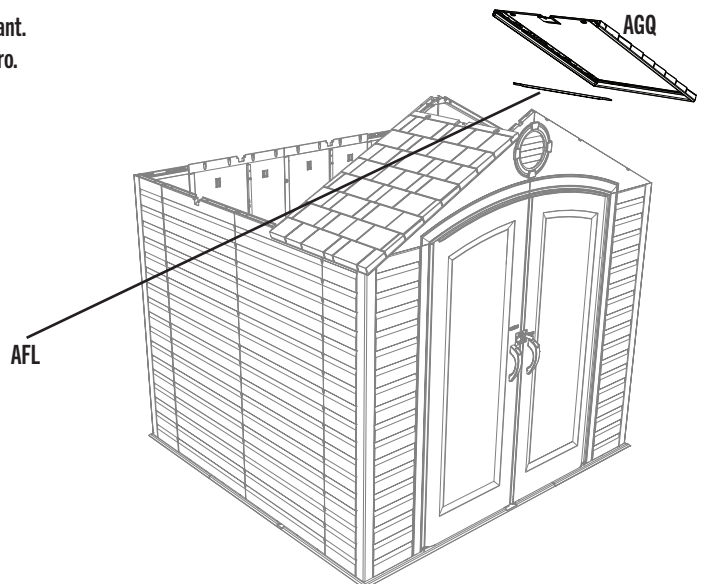

► SECTION 10 (CONTINUED) / SECTION 10 (SUITE) / SECCIÓN 10 (CONTINUACIÓN)

TOOLS AND HARDWARE REQUIRED / OUTILS ET QUINCAILLERIE REQUIS / INSTRUMENTAL Y HERRAJE REQUERIDOS

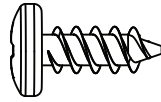

ADZ (x20)

10.7



- Repeat the previous steps for the center roof panels but using ten (10) screws (ADZ) per panel.
- Répétez les étapes précédentes pour les panneaux de toit centraux mais à l'aide de dix (10) vis (ADZ) par panneau.
- Repita los pasos anteriores para los paneles de tejado centrales mas usando diez (10) tornillos (ADZ) por panel.

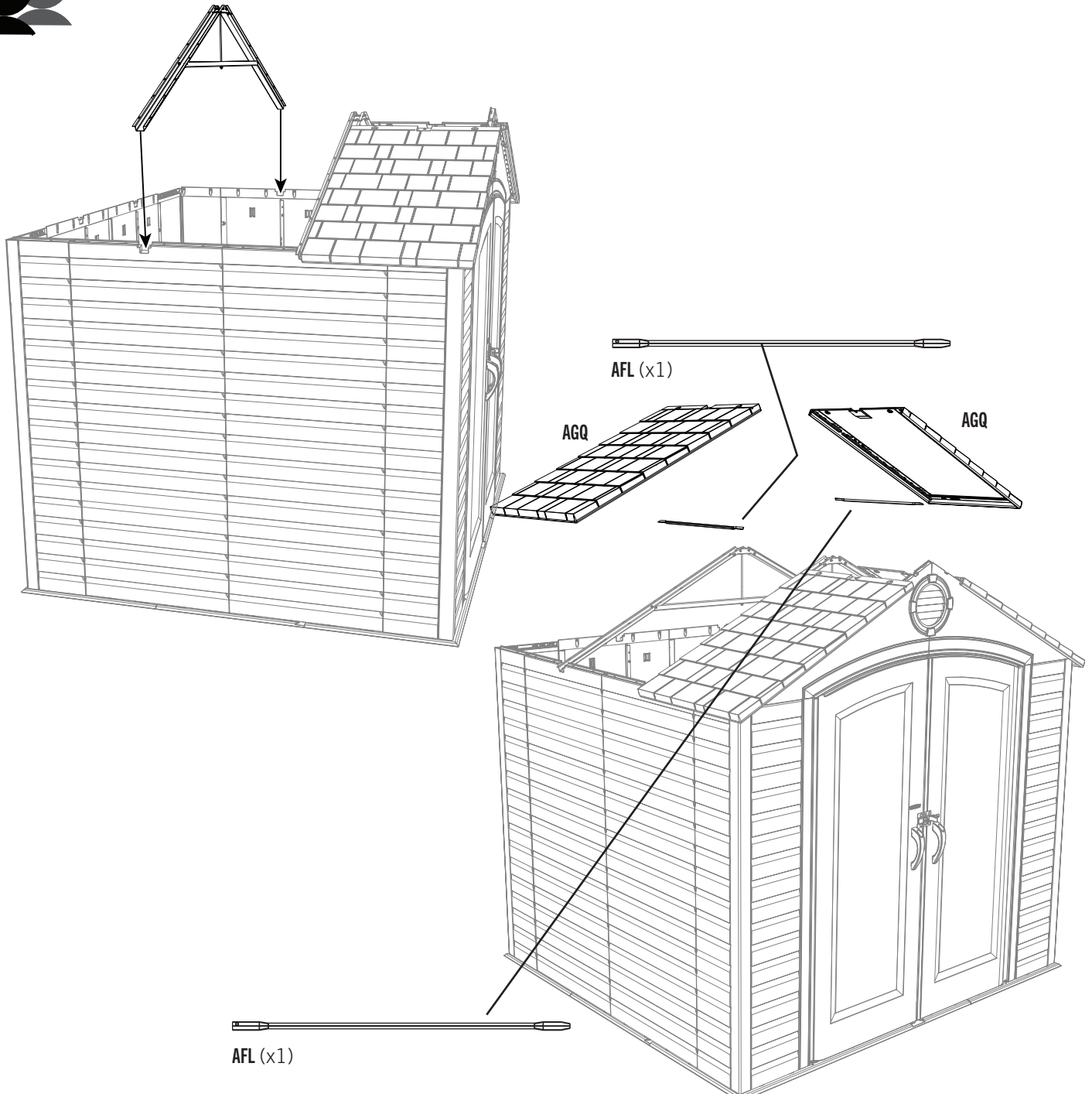

► SECTION 10 (CONTINUED) / SECTION 10 (SUITE) / SECCIÓN 10 (CONTINUACIÓN)

TOOLS AND HARDWARE REQUIRED / OUTILS ET QUINCAILLERIE REQUIS / INSTRUMENTAL Y HERRAJE REQUERIDOS

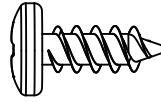

ADZ (x14)

10.8

- Attach the rear gable to the shed using fourteen (14) screws (ADZ).
- Attachez le pignon arrière à l'abri à l'aide de quatorze (14) vis (ADZ).
- Sujete la fachada trasera a la caseta usando catorce (14) tornillos (ADZ).

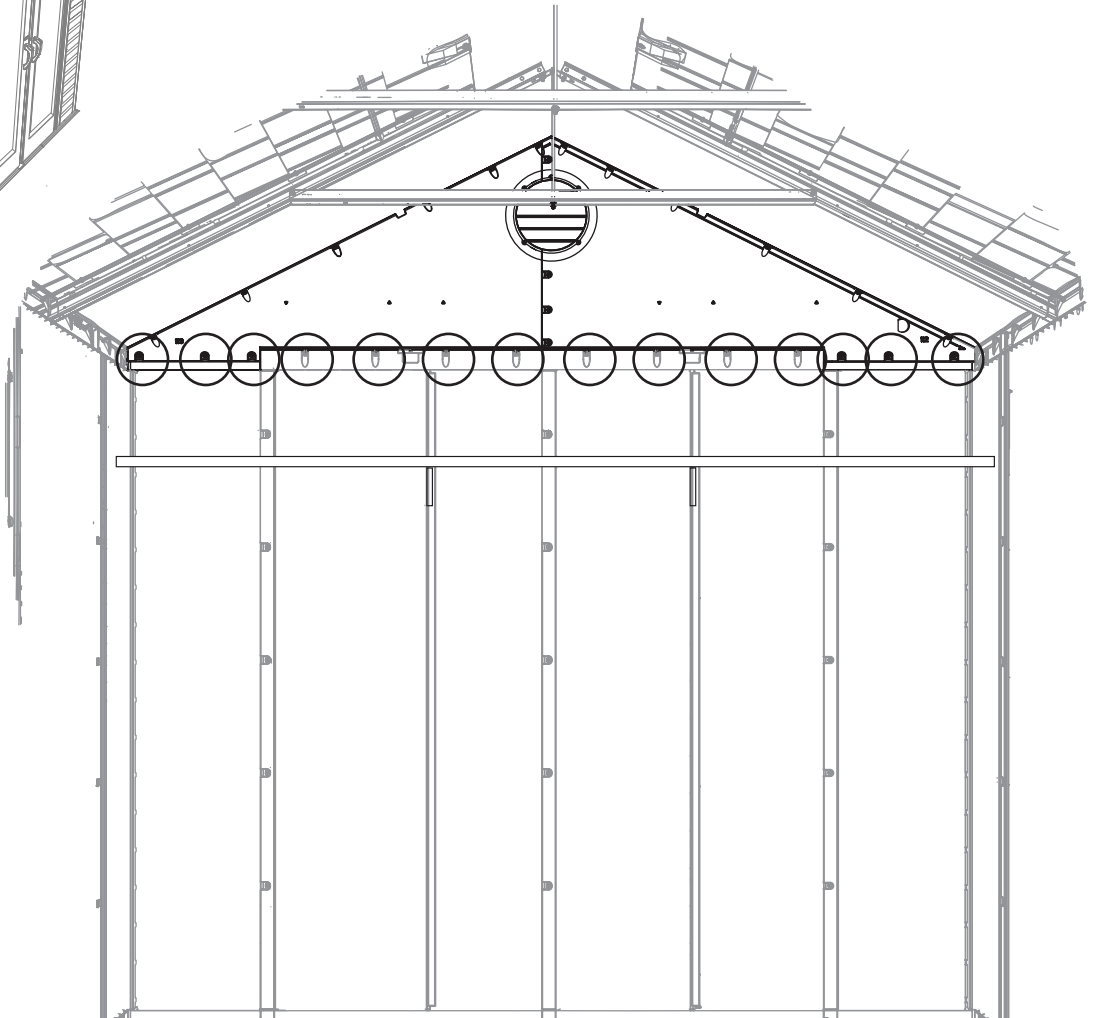
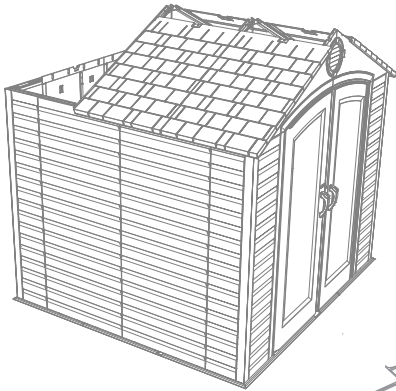
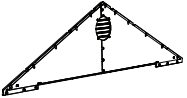

► SECTION 10 (CONTINUED) / SECTION 10 (SUITE) / SECCIÓN 10 (CONTINUACIÓN)

TOOLS AND HARDWARE REQUIRED / OUTILS ET QUINCAILLERIE REQUIS / INSTRUMENTAL Y HERRAJE REQUERIDOS

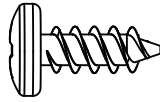

ADZ (x22)

10.9

- Attach the last two roof panels to the shed in the same way you did the first two.
- Attachez les derniers deux panneaux de toit à l'abri dans la même façon que les premiers deux.
- Sujete los últimos dos paneles de tejado a la caseta en la misma manera que los primeros dos.

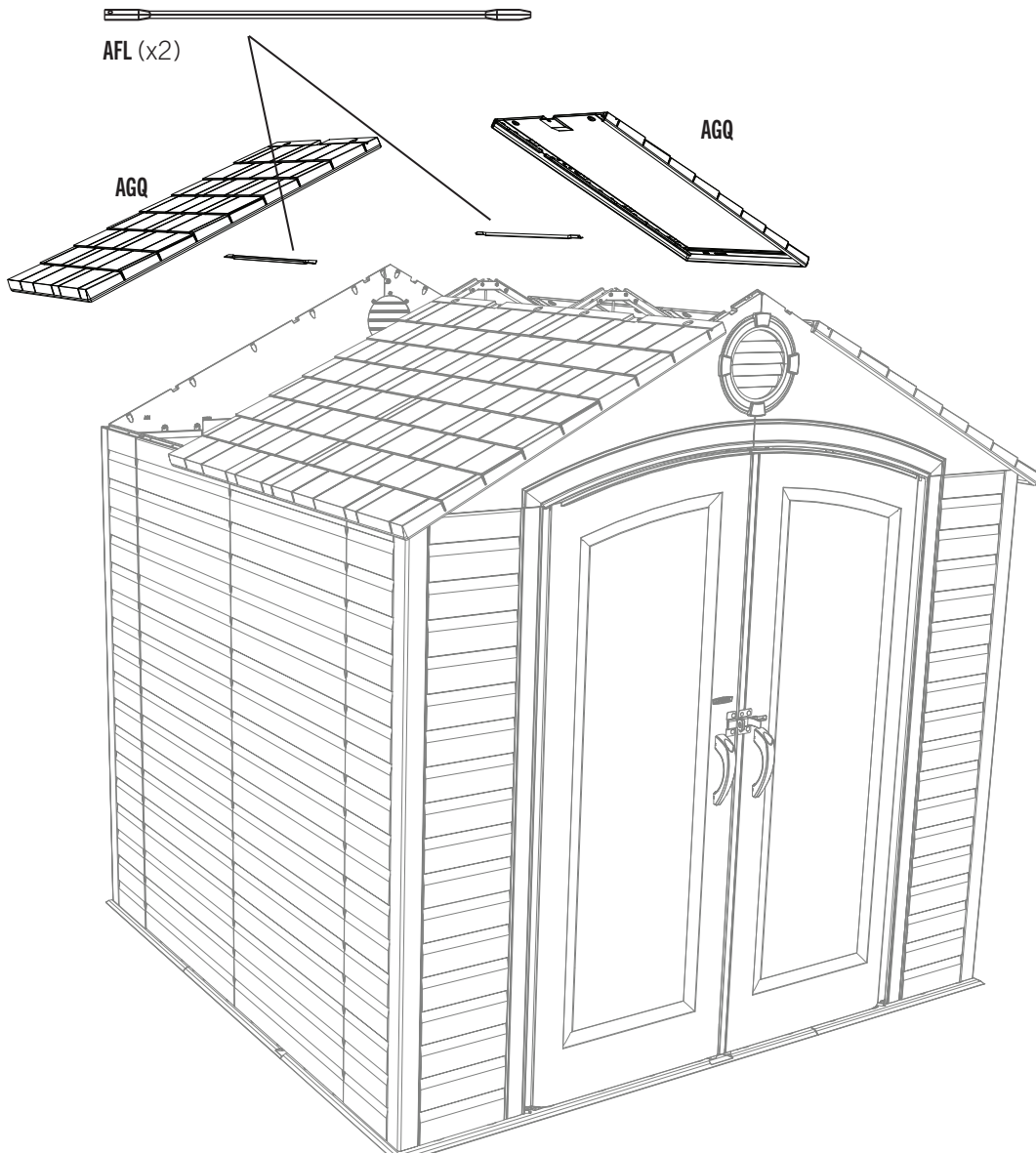

► SECTION 10 (CONTINUED) / SECTION 10 (SUITE) / SECCIÓN 10 (CONTINUACIÓN)

TOOLS AND HARDWARE REQUIRED / OUTILS ET QUINCAILLERIE REQUIS / INSTRUMENTAL Y HERRAJE REQUERIDOS

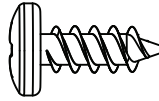

ADZ (x22)

10.10

- Starting at the front, attach the roof caps to the shed using the hardware included.
- En commençant à la partie avant, attachez les chapeaux à l'abri à l'aide de la quincaillerie incluse.
- Empezando a la parte delantera, sujete las cumbres a la caseta usando el herraje incluido.



- The ends of the roof caps overlap one another.
- Les extrémités des chapeaux se chevauchent.
- Los extremos de las cumbres se solapan.

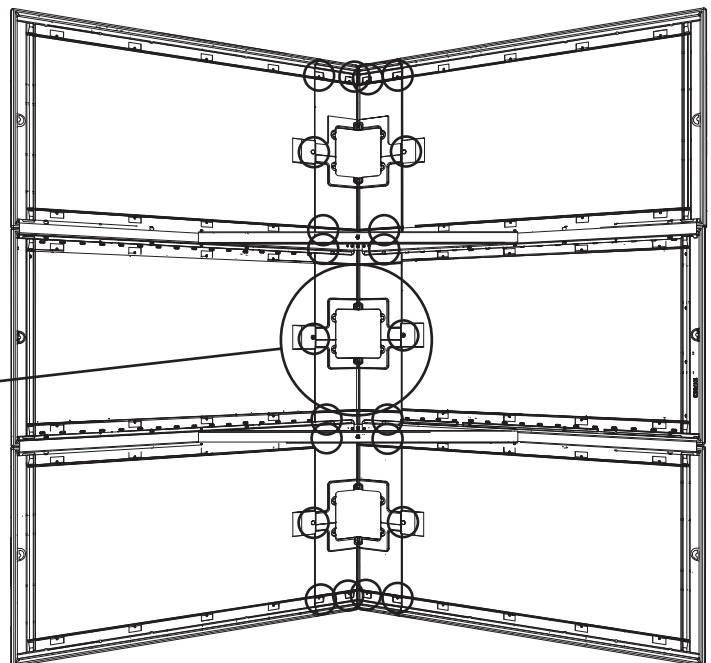
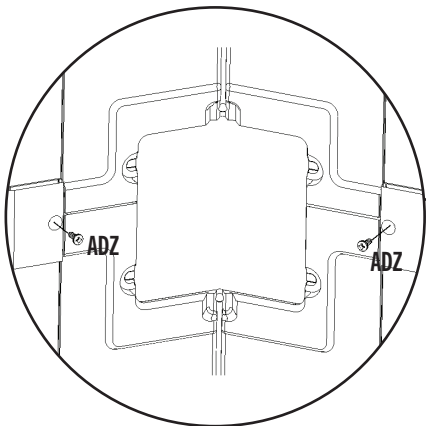
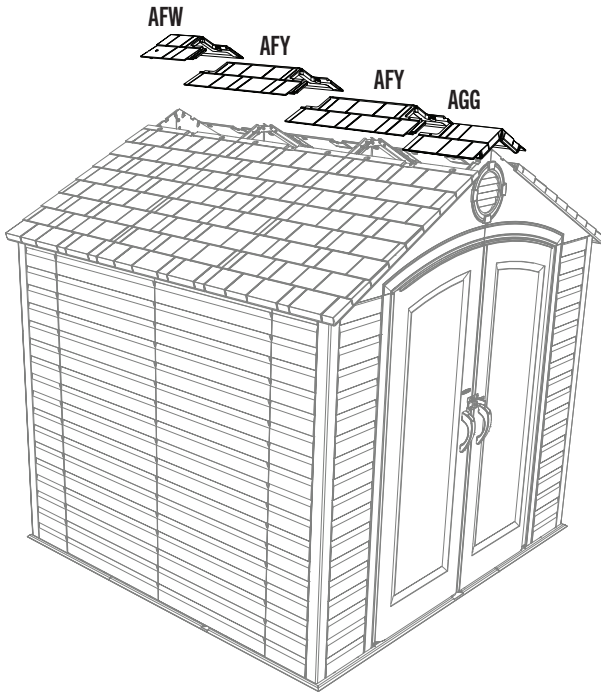

► SECTION 10 (CONTINUED) / SECTION 10 (SUITE) / SECCIÓN 10 (CONTINUACIÓN)

TOOLS AND HARDWARE REQUIRED / OUTILS ET QUINCAILLERIE REQUIS / INSTRUMENTAL Y HERRAJE REQUERIDOS

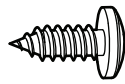

ADX (x18)

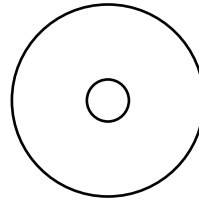

AED (x18)

10.11



- Fold the skylights (AHC), and attach them to the roof using six (6) screws (ADX) and washers (AED) for each skylight.
- Pliez les lucarnes (AHC), et attachez-les au toit à l'aide de six (6) vis (ADX) et rondelles (AED) pour chaque lucarne.
- Doble los tragaluzes (AHC), y sujételos al tejado usando seis (6) tornillos (ADX) y rondanas (AED) para cada tragaluz.

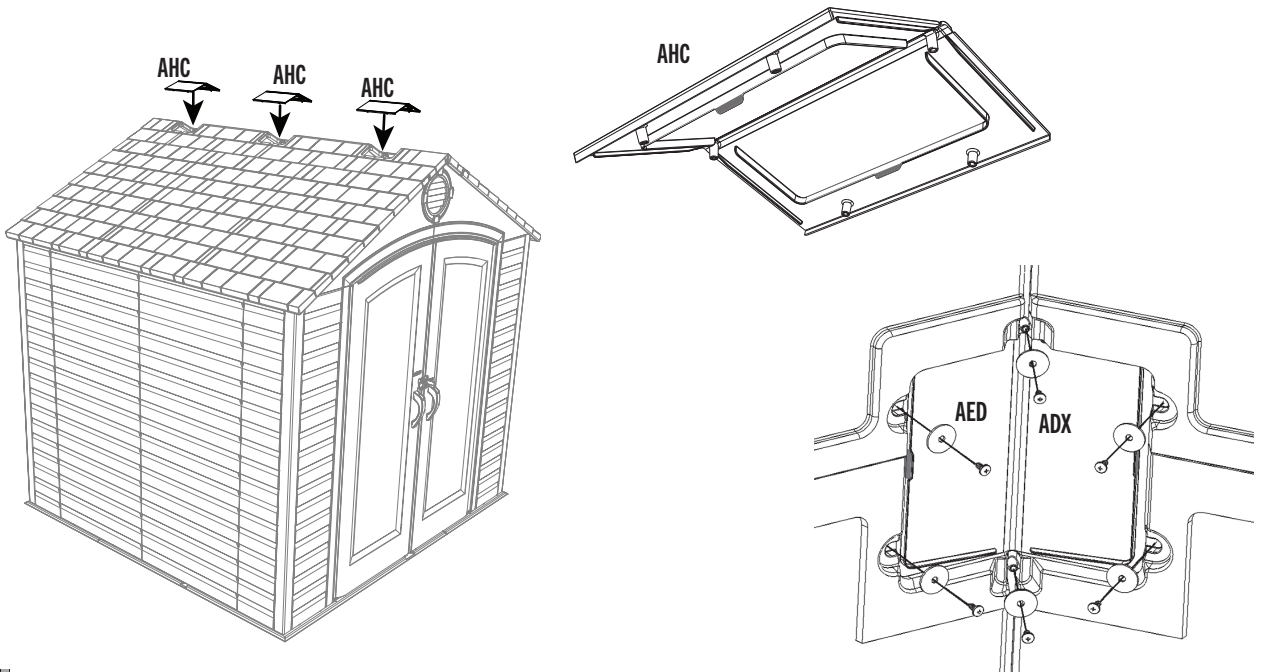

10.12

- Insert the clips (AXX) with the "arrow" facing up.
- Insérez les clips (AXX) avec la « flèche » vers le haut.
- Inserte los clips (AXX) con la « flecha » hacia arriba.

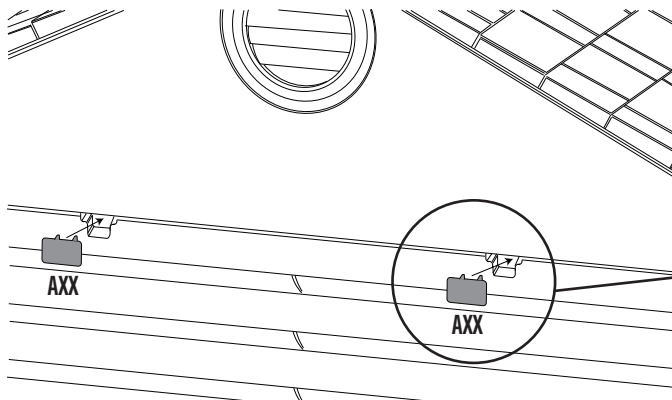
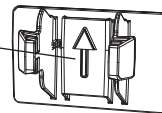

11

DOOR ALIGNMENT / ALIGNEMENT DES PORTES / ALINEACIÓN DE LAS PUERTAS



HARDWARE REQUIRED / QUINCAILLERIE REQUISE / HERRAJE REQUERIDO



PARTS REQUIRED / PIÈCES REQUISES / PIEZAS REQUERIDAS

Plastic parts / Pièces en plastique / Piezas de plástico

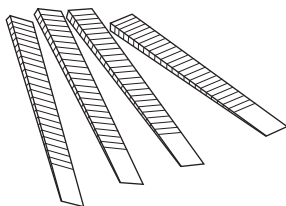

AIX (x4)



TOOLS REQUIRED / OUTILS REQUIS / INSTRUMENTAL REQUERIDO

(Not included—unless otherwise indicated) / (Non inclus — sauf indication contraire*) / (No incluido, salvo indicación contraria*)*

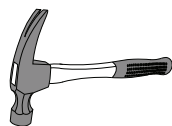

► SECTION 11 (CONTINUED) / SECTION 11 (SUITE) / SECCIÓN 11 (CONTINUACIÓN)

TOOLS AND HARDWARE REQUIRED / OUTILS ET QUINCAILLERIE REQUIS / INSTRUMENTAL Y HERRAJE REQUERIDOS

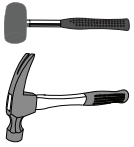

11.1

- If the doors are not level, follow the steps on this page or the next to even them out.
- Si les portes ne sont pas niveaux l'une avec l'autre, suivez les étapes dans cette page ou la suivante pour les niveler.
- Si las puertas no estén niveladas, siga los pasos en esta página o la siguiente para nivelarlas.

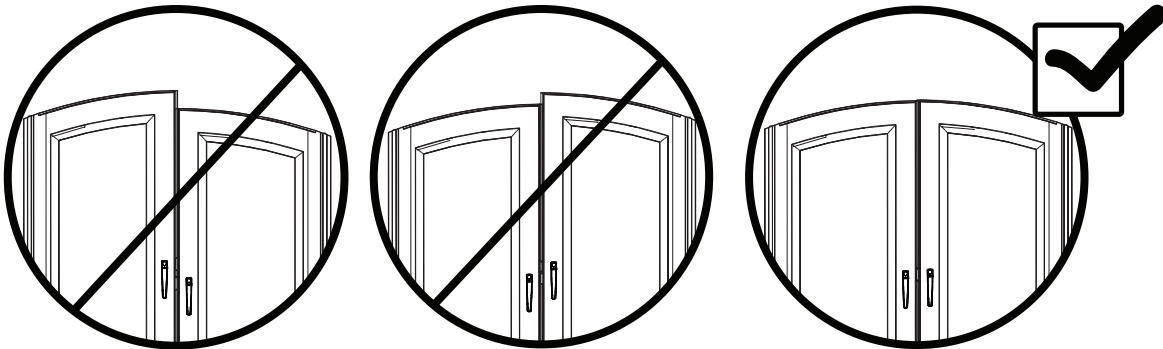

11.2

- If the right door scrapes the floor or is lower than the left door, insert a **shim (AIX)** under the floor directly under the bottom corner of the right door and/or the left rear corner of the shed. If necessary, repeat for the left door until both doors are level and do not scrape. **Break off any excess shim.**
- Si la porte droite frotte en se fermant ou est plus basse que la porte gauche, insérez une **cale (AIX)** sous le plancher directement sous le coin droit inférieur de la porte droite et/ou l'encoignure arrière gauche de l'abri. S'il est nécessaire, répétez cette étape pour la porte gauche jusqu'à ce que les deux portes soient nivelées et ne frottent pas. **Détachez de l'excès des cales.**
- Si la puerta derecha se roza con el piso o es más bajo que la izquierda, inserte una **cuña (AIX)** debajo el piso directamente debajo la esquina inferior derecha de la puerta derecha y/o la esquina izquierda trasera de la caseta. Si es necesario, repita este paso para la puerta izquierda o hasta que las dos puertas estén niveladas y no se rocen. **Quebrante cualquier exceso de las cuñas.**

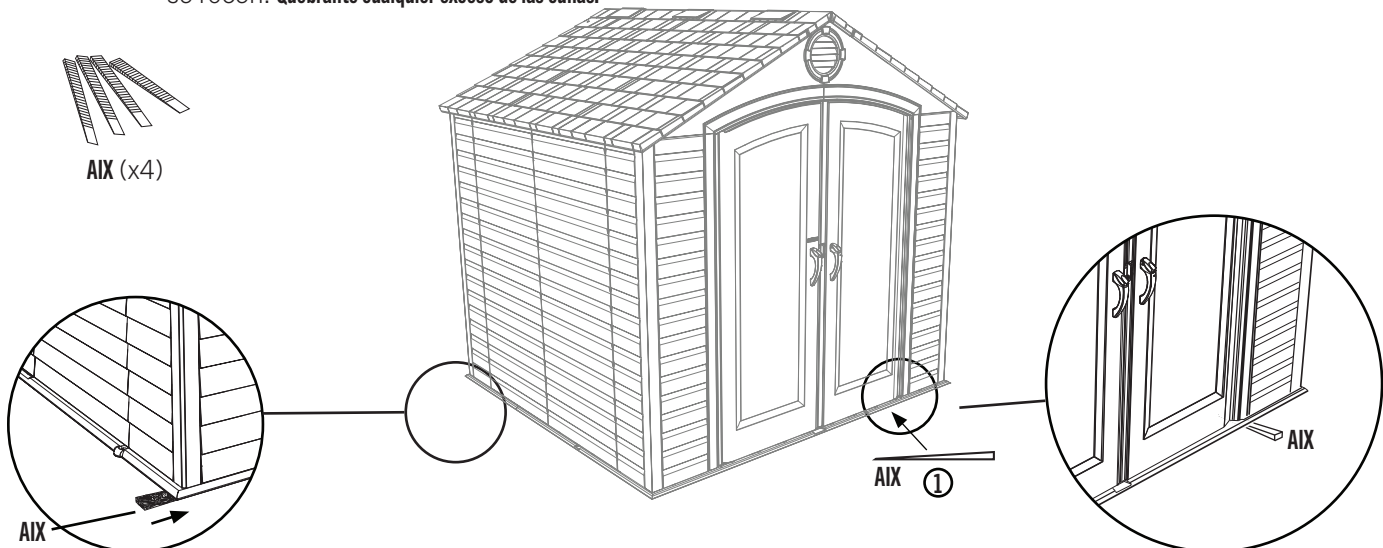



HARDWARE REQUIRED / QUINCAILLERIE REQUISE / HERRAJE REQUERIDO



PARTS REQUIRED / PIÈCES REQUISES / PIEZAS REQUERIDAS



TOOLS REQUIRED / OUTILS REQUIS / INSTRUMENTAL REQUERIDO

(Not included—unless otherwise indicated) / (Non inclus — sauf indication contraire*) / (No incluido, salvo indicación contraria*)*

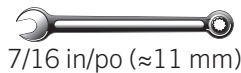
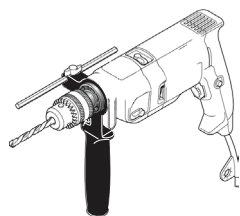

7/16 in/po (≈11 mm)



5/16 in (≈8 mm) Wood drill bit
Foret à boit de 5/16 po (≈8 mm)
Broca para madera de 5/16 in (≈8 mm)



5/16 in (≈8 mm) Masonry drill bit
Foret à maçonnerie de 5/16 po (≈8 mm)
Broca para albañilería de 5/16 in (≈8 mm)

▶ SECTION 12 (CONTINUED) / SECTION 12 (SUITE) / SECCIÓN 12 (CONTINUACIÓN)

FOR A CONCRETE PLATFORM / POUR UNE PLATE-FORME EN BÉTON / PARA UNA PLATAFORMA DE CONCRETO

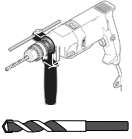

5/16 in/po
(≈8 mm)

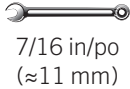

7/16 in/po
(≈11 mm)



12.1

- If you plan on anchoring your shed to a concrete platform, you must purchase the correct anchoring hardware. We recommend using a hammer drill, 5/16" (≈8 mm) masonry bit, six (6) 3/8" x 2" (≈10 mm x ≈5 cm) concrete screws and six (6) 3/8" x 1" (≈10 mm x ≈2,5 cm) Fender Washers.
- Pour ancrer l'abri sur une plateforme de béton, il faut procurer la quincaillerie d'ancrage appropriée. Nous recommandons l'utilisation d'un marteau perforateur, d'un foret de maçonnerie de 5/16 po (≈8 mm), six (6) vis de scellement de 3/8 po x 2 po (≈10 mm x ≈5 cm) et six (6) rondelles de protection de 3/8 po x 1 po (≈10 mm x ≈2,5 cm).
- Para anclar la caseta a una plataforma hecho de concreto, es necesario comprar el herraje de anclaje correcto. Recomendamos usar un rotomartillo, broca para albañilería de 5/16 in (≈8 mm), seis (6) tornillos de anclaje para concreto de 3/8 in x 2 in (≈10 mm x ≈5 cm) y seis (6) rondanas de protección de 3/8 in x 1 in (≈10 mm x ≈2,5 cm).



- Do not exceed a 3/8" (≈10 mm) diameter screw. Refer to your local hardware store for this hardware.
- Ne pas excéder une vis de diamètre de 3/8 po (≈10 mm). Consulter la quincaillerie locale pour cette exigence.
- No usar tornillos que exceden un diámetro de 3/8 in (≈10 mm). Consultar con la ferretería local para obtener este herraje.

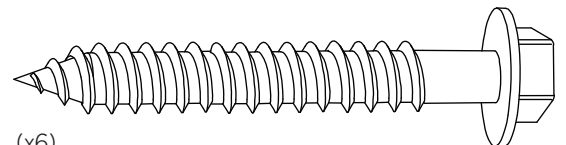
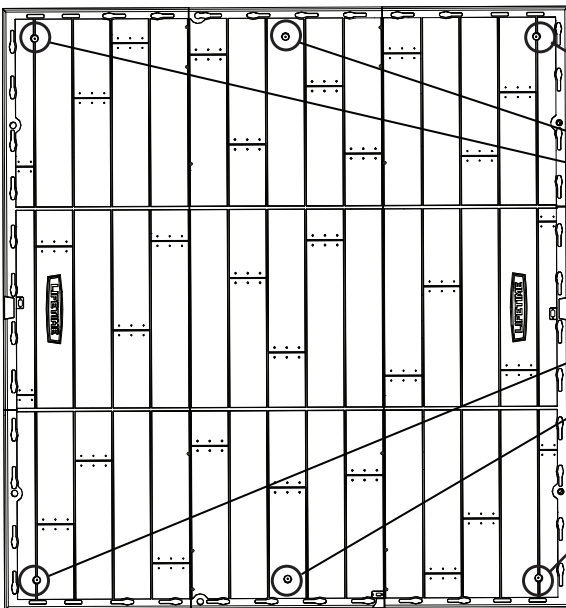

(x6)

(Not included) (Pas incluses) (No incluidas)

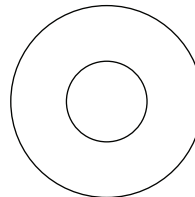

(x6)

(Not included) (Pas incluses) (No incluidas)



WARNING / AVERTISSEMENT / ADVERTENCIA



- Failure to anchor the shed may result in property damage and/or personal injury.
- Si vous n'ancrez pas votre abri, des dommages à la propriété et/ou des blessures peuvent en résulter.
- No anclar la caseta puede resultar en daños a la propiedad y/o en lesiones personales.

► SECTION 12 (CONTINUED) / SECTION 12 (SUITE) / SECCIÓN 12 (CONTINUACIÓN)

FOR A WOOD PLATFORM / POUR UNE PLATE-FORME EN BOIS / PARA UNA PLATAFORMA DE MADERA

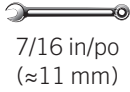

7/16 in/po
(≈11 mm)



5/16 in/po
(≈8 mm)



12.1

- If you plan on anchoring your shed to a wood platform, you must purchase the correct anchoring hardware. We recommend using a drill, 5/16" (≈8 mm) drill bit, six (6) 3/8" x 1 1/2" (≈10 mm x ≈4 cm) lag screws and six (6) 3/8" x 1" (≈10 mm x ≈2,5 cm) fender washers.
- Si vous désirez ancrer votre abri à une plate-forme en bois, il faut acheter la quincaillerie d'ancrage correcte. Nous recommandons l'utilisation d'une perceuse, d'une mèche de 5/16 po (≈8 mm), six (6) tirefonds de 3/8 po x 1 1/2 po (≈10 mm x ≈4 cm) et six (6) rondelles de protection de 3/8 po x 1 po (≈10 mm x ≈2,5 cm).
- Si desea anclar su caseta a una plataforma hecho de madera, es necesario comprar el herraje de anclaje correcto. Recomendamos usar un taladro eléctrico, una broca de 5/16 in (≈8 mm), seis (6) tornillos para compresión de 3/8 in x 1 1/2 in (≈10 mm x ≈4 cm), y seis (6) rondanas de protección de 3/8 in x 1 in (≈10 mm x ≈2,5 cm).



- Do not exceed a 3/8" (≈10 mm) diameter screw. Refer to your local hardware store for this hardware.
- Ne pas excéder une vis de diamètre de 3/8 po (≈10 mm). Consulter la quincaillerie locale pour cette exigence.
- No usar tornillos que exceden un diámetro de 3/8 in (≈10 mm). Consultar con la ferretería local para obtener este herraje.

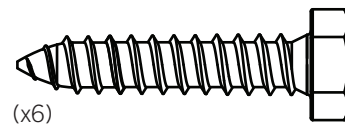
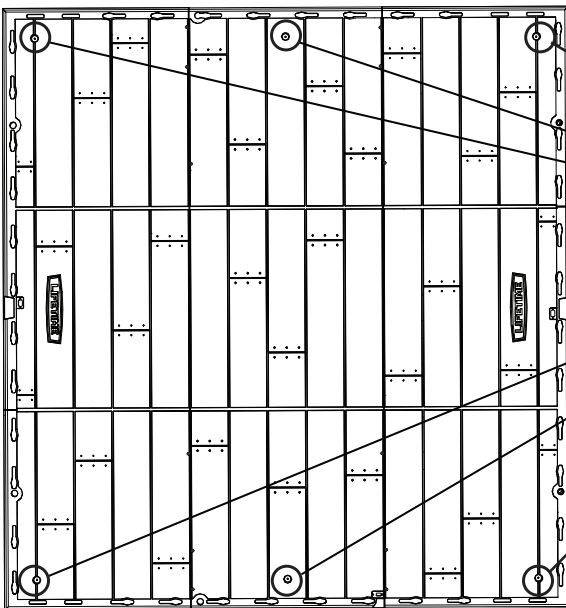

(x6)

(Not included) (Pas incluses) (No incluidas)

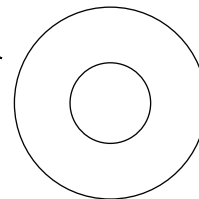

(x6)

(Not included) (Pas incluses) (No incluidas)



WARNING / AVERTISSEMENT / ADVERTENCIA



- Failure to anchor the shed may result in property damage and/or personal injury.
- Si vous n'ancrez pas votre abri, des dommages à la propriété et/ou des blessures peuvent en résulter.
- No anclar la caseta puede resultar en daños a la propiedad y/o en lesiones personales.

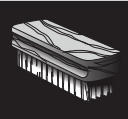

CLEANING & CARE

Congratulations on your Lifetime® product purchase. By following the instructions below, your new Lifetime product should provide you with years of service and enjoyment.

The polyethylene panels are stain and solvent resistant. Most stains can be removed using a mild soap and a soft-bristled brush. Abrasive cleaning materials may scratch the plastic and are not recommended. Repair scratches or rust spots on the metal by sanding the affected area lightly; using a rust preventative spray primer; and finally, spraying with a high-gloss spray enamel paint. Avoid placing a direct heat source on or near surfaces unless using a heat barrier.

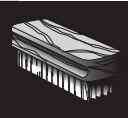

NETTOYAGE ET ENTRETIEN

Nous vous félicitons d'avoir acheté ce produit Lifetime®. En suivant les instructions ci-dessous, votre nouveau produit Lifetime devrait vous fournir des années de service et de plaisir.

Les murs et les étagères en polyéthylène sont résistants aux taches et solvants de nettoyage. Pour les nettoyer, se servir d'un savon doux et d'une brosse douce. Les produits abrasifs de nettoyage risquent d'égratigner le plastique et ne sont pas recommandés. Pour réparer les égratignures ou taches de rouille sur le métal, frotter légèrement l'endroit affecté au papier de verre, puis passer une couche de produit vaporisant préventif, et, enfin, vaporiser une peinture émail ultrabrillante. Éviter de placer une source de chaleur directe sur ou près des surfaces, ou les protéger à l'aide d'une protection contre la chaleur.



LIMPIEZA Y CUIDADO

Felicidades por la compra de su producto Lifetime®. Al seguir las siguientes instrucciones, su nuevo producto Lifetime le brindará años de servicio y satisfacción.

Los paneles de polietileno son resistentes a las manchas y solventes. La mayoría de las manchas puede removerse usando un jabón suave y un cepillo de cerdas suaves. Los materiales abrasivos para limpieza pueden rayar el plástico y no se recomiendan. Reparar rayones o manchas de óxido en el metal, lijando suavemente la parte afectada; usando un aerosol preventivo de óxido y finalmente, rociando con una pintura de esmalte brillante. Evitar poner una fuente de calor directa en o cerca de las superficies sin usar una barrera de calor.



REGISTER YOUR PRODUCT ONLINE AT WWW.LIFETIME.COM

At Lifetime®, we are committed to providing innovative and quality products. While registering, you will have the opportunity to give us your feedback. Your input is valuable to us.

- You can also opt in to receive new product notifications or promotions.
- In the unlikely event of a product recall or safety modification, your registration provides the information we need to notify you directly.
- Registration is fast, easy, and completely voluntary.

LIFETIME'S PROMISE TO YOU:

Maintaining your privacy is our long-standing policy at Lifetime®. And you can rest assured that Lifetime® will not sell or provide your personal data to other third parties, or allow them to use your personal data for their own purposes.

We invite you to read our privacy policy at www.lifetime.com

REGISTER today!



ENREGISTRER CE PRODUIT EN LIGNE À WWW.LIFETIME.COM

Chez Lifetime®, nous nous engageons à fournir des produits innovateurs de qualité. Lors de votre inscription, vous aurez l'occasion de nous faire parvenir vos commentaires. Votre opinion est importante pour nous.

- On peut également choisir de recevoir des avis ou des promotions dans le cadre de nouveaux produits.
- Dans l'éventualité improbable d'un rappel ou d'un avis de sécurité, l'inscription fournit les renseignements nécessaires nous permettant de communiquer avec vous.
- L'inscription est rapide, facile et complètement volontaire.

LA PROMESSE DE LIFETIME:

Conserver votre confidentialité est notre politique de longue date chez Lifetime®. Vous pouvez donc être rassuré par le fait que Lifetime® ne vendra pas ou ne fournira pas vos données personnelles à des tiers, et ne leur permettra pas d'utiliser vos données personnelles à leurs propres fins.

Nous vous invitons à lire notre politique de confidentialité à www.lifetime.com (en anglais seulement)

ENREGISTRER CE PRODUIT aujourd'hui!



REGISTRAR EL PRODUCTO EN LÍNEA EN WWW.LIFETIME.COM

En Lifetime®, estamos comprometidos a ofrecer productos innovadores y de calidad. Al registrarse, usted tendrá la oportunidad de darnos su retroalimentación. Su información es valiosa para nosotros.

- También puede optar por recibir nuestras notificaciones o promociones.
- En el caso improbable de que el producto deba ser retirado del mercado o que sufra alguna modificación, su registro provee la información que necesitamos para notificarle directamente.
- El registro es rápido, fácil y completamente voluntario.

LA PROMESA DE LIFETIME® PARA USTED:

Mantener privacidad es nuestra política permanente en Lifetime®. Y puede estar seguro que Lifetime® no venderá ni dará datos personales a terceros, ni les permitirá usar datos personales para sus propios fines.

Lo invitamos a leer nuestra política de privacidad en www.lifetime.com (sólo en inglés)

¡REGISTRARSE hoy mismo!



NOTES / REMARQUES / NOTAS

A large, empty white rectangular area intended for writing notes or remarks.



10-YEAR LIMITED FACTORY WARRANTY

THE MANUFACTURER RESERVES THE RIGHT TO MAKE SUBSTITUTIONS TO WARRANTY CLAIMS IF PARTS ARE UNAVAILABLE OR OBSOLETE.

Lifetime Lawn and Garden products are warranted to the original purchaser to be free from defects in material or workmanship for a period of 10 years from the date of original retail purchase. The word “defects” is defined as imperfections that impair the use of the product. Defects resulting from misuse, abuse or negligence will void this warranty. This warranty does not cover defects due to improper installation, alteration or accident. Lifetime recommends that no modifications be made to this product. This warranty does not cover damage caused by vandalism, rusting, “acts of nature”, natural disasters, normal wear and tear, or any other event beyond the control of the manufacturer.

This warranty is nontransferable and is expressly limited to the repair or replacement of defective products. If the product is defective within the terms of this warranty, Lifetime Products, Inc. will repair or replace defective parts at no cost to the purchaser. Shipping charges to and from the factory or distribution center are not covered and are the responsibility of the purchaser. Labor charges and related expenses for removal, installation or replacement of the product or its components are not covered under this warranty.

This warranty does not cover scratching, scuffing, or other cosmetic damage of the product that may result from normal usage. In addition, defects resulting from intentional damage, negligence, or unreasonable use will void this warranty / are not covered by this warranty.

Liability for incidental or consequential damages is excluded to the extent permitted by law. All merchandise is sold on this condition, and no representative of the company may waive or change this policy. This product is not intended for institutional or commercial use; Lifetime Products, Inc. does not assume any liability for such use. Institutional or commercial use will void the warranty.

This warranty is expressly in lieu of all other warranties, expressed or implied, including warranties of merchantability or fitness for use to extent permitted by Federal and state law. Neither Lifetime Products, Inc., nor any representative assumes any other liability in connection with this product. This warranty gives you specific legal rights, and you may also have other rights which vary from state to state.

AUSTRALIA : Our goods come with guarantees that cannot be excluded under the Australian Consumer Law. You are entitled to a replacement or refund for a major failure and for compensation for any other reasonably foreseeable loss or damage. You are also entitled to have the goods repaired or replaced if the goods fail to be of acceptable quality and the failure does not amount to a major failure.

**ALL WARRANTY CLAIMS MUST BE ACCOMPANIED BY A SALES RECEIPT.
REPORT PRODUCT DEFECTS IN WRITING TO:**

LIFETIME PRODUCTS, INC.,
PO Box 160010
Freeport Center, Bldg. D-12
Clearfield, UT 84016-0010

For online warranty claims, please visit: www.lifetime.com/warranty
Warranty Department: (800) 225-3865

FOR INTERNATIONAL WARRANTY:

All warranty claims must be accompanied by a sales receipt. Report product defects in writing to your regional sales support representative. Please include your dated sales receipt and photographs of damaged parts.

To Identify the representative for your region, please visit: www.lifetime.com/international



GARANTIE DE FABRICATION LIMITÉE DE 10 ANS

LIFETIME® PRODUCTS, INC. RÉSERVE LE DROIT DE FAIRE DES SUBSTITUTIONS EN CAS DE RECOURS EN GARANTIE SI LES PIÈCES NE SONT PAS DISPONIBLES OU SONT OBSOLÈTES.

L'acheteur d'origine des produits pour pelouses et jardins de Lifetime bénéficie d'une garantie contre toute défectuosité de matériel et de fabrication pour une période de 10 ans à compter de la date d'achat. On entend par « défaut » une imperfection qui nuit à l'utilisation du produit. Tout défaut découlant d'une mauvaise utilisation, d'un abus ou d'une négligence a pour effet d'annuler cette garantie. Cette garantie ne couvre pas les défauts attribuables à une installation inadéquate, une altération ou un accident. Lifetime recommande de ne pas apporter de modifications à ce produit. Cette garantie ne couvre pas les dommages causés par le vandalisme, la corrosion par la rouille, les cas de « force majeure », les catastrophes naturelles, la détérioration et l'usure normales et tout autre événement indépendant de la volonté du fabricant.

Cette garantie n'est pas transférable et se limite expressément à la réparation ou au remplacement d'un produit défectueux. Si le produit est défectueux au sens de cette garantie, Lifetime Products, Inc. réparera ou remplacera les pièces défectueuses sans frais pour l'acheteur. Les frais d'expédition en partance ou en provenance de l'usine ou du centre de distribution ne sont pas couverts et incombent à l'acheteur. Les coûts relatifs à la main-d'œuvre et les autres frais liés au retrait, à l'installation ou au remplacement du produit ou de ses composants ne sont pas couverts par cette garantie.

Cette garantie ne couvre pas les rayures, les égratignures ou autres dommages esthétiques du produit découlant d'un usage normal. De plus, tout défaut découlant d'un dommage volontaire, de négligence ou d'un usage déraisonnable annule cette garantie et n'est pas couvert par cette garantie.

Dans la mesure permise par la loi, la société n'est pas responsable des dommages indirects ou accessoires. Toute marchandise est vendue à cette condition et aucun représentant de la société ne peut renoncer à l'application de cette politique ou la modifier. Ce produit n'est pas destiné à des fins institutionnelles ou commerciales; Lifetime Products, Inc. n'assume aucune responsabilité à cet égard. Toute utilisation institutionnelle ou commerciale annule la garantie.

La présente garantie remplace expressément toute autre garantie, expresse ou implicite, y compris les garanties de qualité marchande ou d'adaptation à un usage particulier dans la mesure permise par les lois du pays ou de l'État. Ni Lifetime Products, Inc. ni aucun de ses représentants n'assument une quelconque responsabilité en lien avec ce produit. Cette garantie vous donne des droits juridiques précis et vous pourriez également avoir d'autres droits selon l'État ou la province.

AUSTRALIE: La garantie qui accompagne nos produits ne peut être exclue en vertu de la loi sur la protection du consommateur de l'Australie. Le client a droit à un remplacement ou à un remboursement en cas de bris majeur et pour toute autre perte ou dommage raisonnablement prévisible. Le client a aussi droit à ce que les produits soient réparés ou remplacés si un bris survient et rend la qualité inacceptable sans pour autant être qualifiable de bris majeur.

**TOUTE RÉCLAMATION EN VERTU DE LA GARANTIE DOIT ÊTRE ACCOMPAGNÉE D'UN REÇU DE VENTE.
SIGNALEMENT ÉCRIT DE TOUT PRODUIT DÉFECTUEUX:**

LIFETIME PRODUCTS, INC.,
PO Box 160010
Freeport Center, Bldg. D-12
Clearfield, UT 84016-0010

Pour effectuer en ligne une réclamation sous garantie, consultez cette adresse : www.lifetime.com/warranty
Service de la garantie : (800) 225-3865

GARANTIE INTERNATIONALE:

Toute réclamation en vertu de la garantie doit être accompagnée d'un reçu de vente. Veuillez signaler par écrit tout produit défectueux au représentant du soutien aux ventes de votre région. Veuillez inclure le reçu de vente daté ainsi que des photographies des pièces endommagées.

Pour connaître le représentant de votre région, veuillez consulter le : www.lifetime.com/international



GARANTÍA DE FÁBRICA LIMITADA POR 10 AÑOS

EL FABRICANTE SE RESERVA EL DERECHO DE HACER SUSTITUCIONES EN LOS ELEMENTOS REEMPLAZADOS BAJO GARANTÍA SI LAS PIEZAS NO ESTÁN DISPONIBLES O SON OBSOLETAS.

El comprador original recibe una garantía de que los productos de césped y jardín de Lifetime están libres de defectos de material o mano de obra durante un período de 10 años a partir de la fecha de compra original al por menor. La palabra “defectos” se define como imperfección que imposibilita el uso del producto. Los defectos ocasionados por el mal uso, el abuso o la negligencia anularán esta garantía. Esta garantía no cubre los defectos debidos a una instalación incorrecta, una alteración o un accidente. Lifetime recomienda que no se realicen modificaciones en este producto. Esta garantía no cubre los daños causados por vandalismo, oxidación, “actos de la naturaleza”, desastres naturales, desgaste normal o cualquier otro evento fuera del control del fabricante.

Esta garantía no es transferible y se limita expresamente a la reparación o reemplazo de productos defectuosos. Si el producto resulta defectuoso dentro de los términos de esta garantía, Lifetime Products, Inc. reparará o reemplazará las piezas defectuosas sin costo alguno para el comprador. Los gastos de envío hacia y desde la fábrica o el centro de distribución no están cubiertos y son la responsabilidad del comprador. La mano de obra y los gastos relacionados por la remoción, la instalación o la sustitución del producto o sus componentes no están cubiertos por esta garantía.

Esta garantía no cubre los rayones, los raspones ni otros daños superficiales del producto que pueden resultar del uso normal. Asimismo, los defectos resultantes de daños intencionales, negligencia o uso indebido anularán o no están cubiertos por esta garantía.

Se excluye la responsabilidad por daños imprevistos o derivados en la medida en que lo permita la ley. Toda la mercancía se vende bajo estas condiciones y ningún representante de la empresa puede renunciar a ni cambiar esta política. Este producto no está destinado para uso institucional o comercial; Lifetime Products, Inc. no asume ninguna responsabilidad por dicho uso. El uso institucional o comercial anulará la garantía.

Esta garantía sustituye expresamente cualquier otra garantía, expresa o implícita, incluidas las garantías de comercialización o idoneidad para su uso en la medida permitida por la ley federal y estatal. Ni Lifetime Products, Inc., ni ningún representante asume ninguna otra responsabilidad en relación con este producto. Esta garantía le otorga derechos legales específicos y usted también puede tener otros derechos que varían de un estado a otro.

AUSTRALIA : Nuestros productos vienen con garantías que no se pueden excluir bajo la Ley Australiana del Consumidor. Usted tiene derecho a recibir un reemplazo o reembolso por un fallo grave y compensación por cualquier otra pérdida o daño razonablemente previsible. También tiene derecho a la reparación o el reemplazo de los bienes si los bienes no son de calidad aceptable y el fallo no supone un fallo grave.

TODOS LOS RECLAMOS DE GARANTÍA DEBEN ESTAR ACOMPAÑADOS POR UN RECIBO DE COMPRA. REPORTE LOS DEFECTOS DEL PRODUCTO POR ESCRITO A:

LIFETIME PRODUCTS, INC.,
PO Box 160010
Freeport Center, Bldg. D-12
Clearfield, UT 84016-0010

Para realizar reclamos de garantía por internet, visite: www.lifetime.com/warranty.
Departamento de Garantías: (800) 225-3865

PARA LA GARANTÍA INTERNACIONAL:

Todos los reclamos de garantía deben estar acompañados por un recibo de compra. Reporte los defectos del producto por escrito a su representante regional de apoyo de ventas. Por favor, incluya su recibo de compra con la fecha y fotografías de las piezas dañadas.

Para identificar al representante de su región, por favor visite: www.lifetime.com/international

GARANTIA NO VÁLIDA EN MÉXICO

ENHANCE YOUR LIFETIME® PURCHASE BY ADDING ACCESSORIES OR OTHER GREAT PRODUCTS

To purchase accessories or other Lifetime® products, visit us at:

www.lifetime.com

Or call: 1-800-424-3865

AMÉLIORER L'ACHAT LIFETIME® EN AJOUTANT DES ACCESSOIRES OU D'AUTRES PRODUITS

Pour acheter des accessoires ou des autres produits Lifetime®, visiter le :

www.lifetime.com

Ou composer le 1-800-424-3865

MEJORAR LA COMPRA DE LIFETIME® AGREGANDO ACCESORIOS U OTROS MARAVILLOSOS PRODUCTOS

Para comprar accesorios u otros productos de Lifetime®, visitarnos en:

www.lifetime.com

O marcar al 1-800-424-3865



www.lifetime.com

