

### 1 Inspect Your Entryway

Check for any obstructions above and around your entryway that may prevent the outward swing of your new security door, and/or its installation, such as:

- Light fixtures
- Low overhang
- Trees, bushes, or hanging plants
- Door bell
- Door handle of your existing entry door

Standard security door handle height is 39-1/2". To check for potential interference with your main entry door handle, measure from the threshold to the center of the handle. A measurement within 38-1/2" - 40-1/2" may result in interference. To ensure you avoid interference issues in this instance, you may:

- Mount your security door with an opposite swing (see Step 3)
- Build out the trim on your mounting surface to create clearance

**Note:** Paddle style handles feature a profile less likely to cause interference than knob style handles...if measurements indicate you may be close to an interference issue, keep this in mind when selecting your security door handle set.



### 2 Determine Mounting Method and Rough Opening Measuring Points

The security door will require a minimum mounting surface of 1" on the trim above and on both sides of the entry door (1" depth also required for recessed mount). Mounting screws must be secured to a stud in the wall. Review **Figures 1-5** to determine which mounting method you can and wish to use and the rough opening measurement.

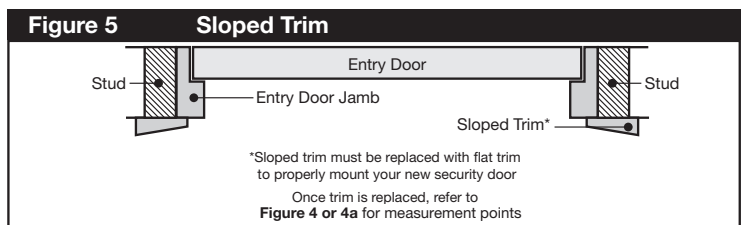
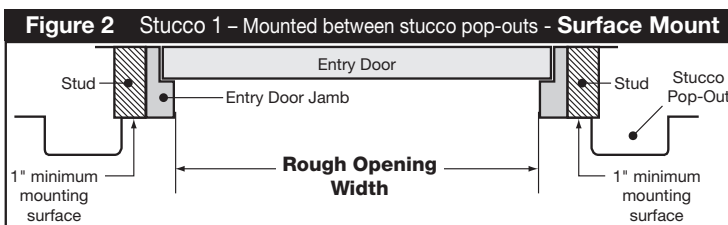
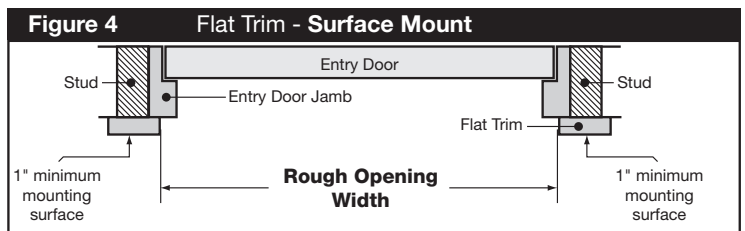
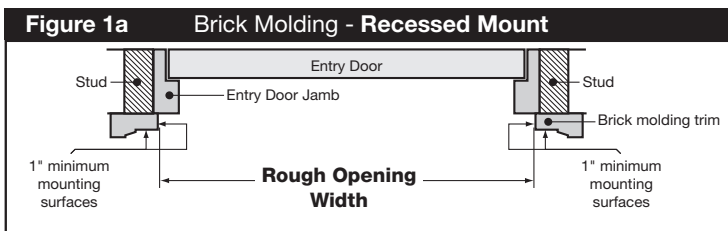
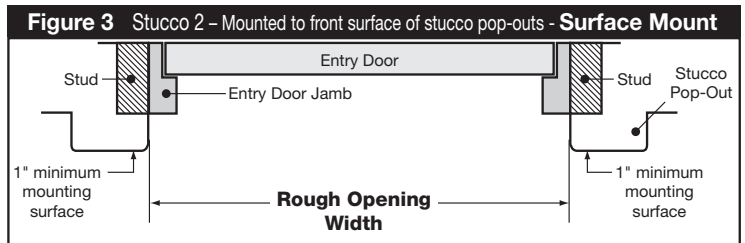
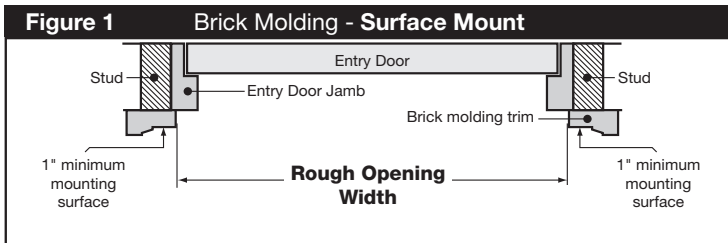

### 3 Determine Door Swing

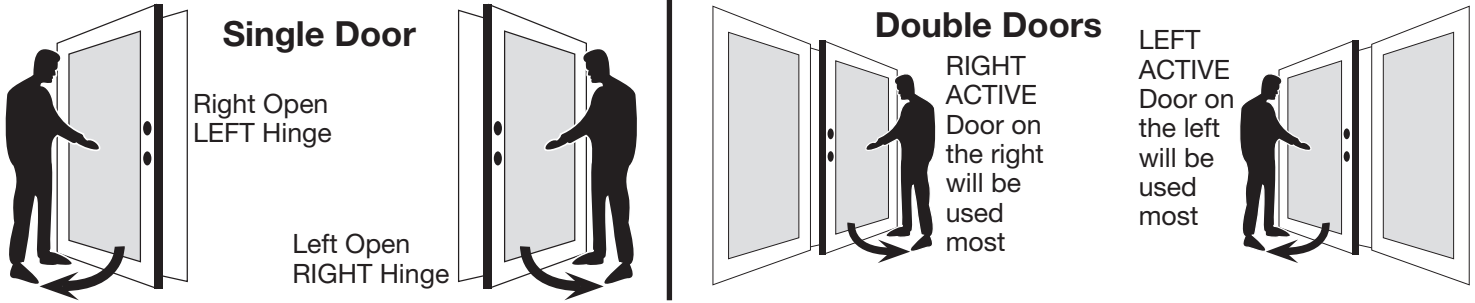

#### Left or Right?

Determined by hinge side, as viewed from outside (see illustrations) **Note:** most doors are reversible but some designs are handing specific

### 4 Measure Width

#### Measure for Rough Opening Width

Measure for the rough opening you identified in Step 2 (Figures 1-5). Measure the top, middle and the bottom of the door opening. The smallest of the three measurements will be your rough opening width. Enter that measurement on the measurement worksheet and follow the instructions to determine if a standard size door will fit or to order the correct custom sized door.

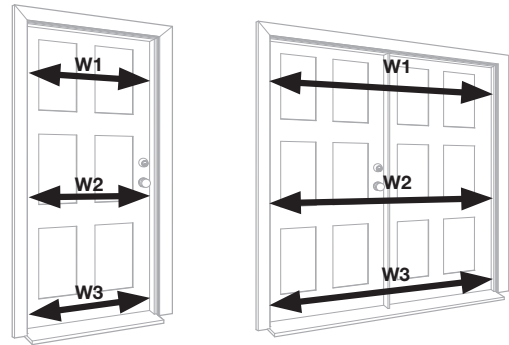

### 5 Measure Height

#### Measure for Rough Opening Height

Measure from the bottom edge of the mounting surface to the existing threshold of your entry door and enter on the measurement worksheet on the following page.

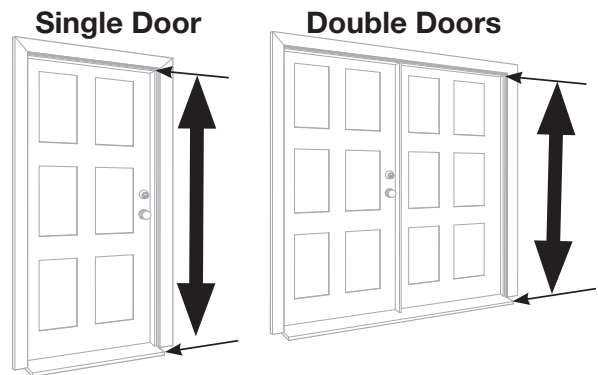

### 6 Record Measurements

#### Height

Measure the height from the threshold to the underside of the exterior trim at the top of the door.

#### Width

The rough opening width is measured from the distance across the existing entry door frame from inside edge to inside edge.

Use the **SMALLEST** of the 3 measurements if they vary.

W1 \_\_\_\_\_ W2 \_\_\_\_\_ W3 \_\_\_\_\_  
Record door width

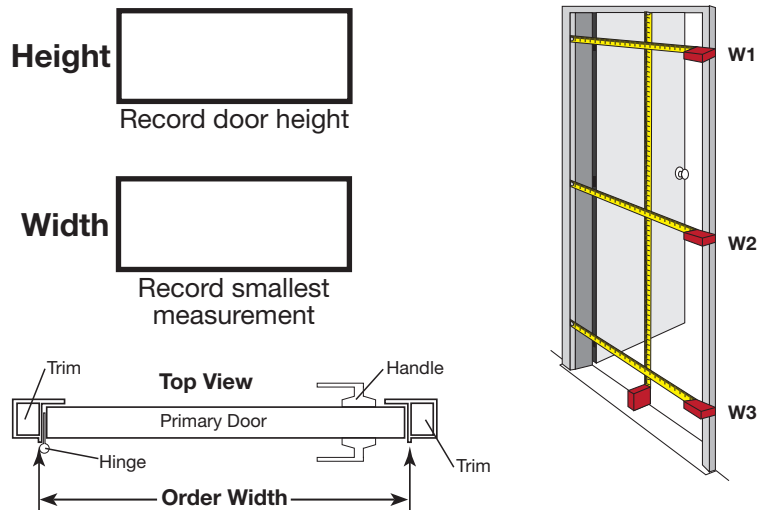

## 7 Determine Which Doors & Sizes Will Fit

Once you have measured for height and width, use the following charts to determine which models and sizes will fit in your opening. If your opening height and width measurements are within the Rough Opening Fit Range listed for the size and model in question, that Call Size will fit your opening when properly installed. If you have an unusual size opening and none of the models and standard sizes listed will fit, see a Home Depot associate to review your custom size security door options in the MyCD system.

# SURFACE MOUNT

## Fit Range - Standard Sizes

Some models are available in custom sizes. See a Home Depot associate and ask to look at options in the MyCD system.

Model	Call Size	Rough Opening Fit Range	Overall Frame Size	Call Size	Rough Opening Fit Range	Overall Frame Size
Arcada	32"	31-1/2" - 32-1/2"	34-1/2"	80"	79-3/4" - 80-1/2"	81-9/16"
	36"	35-1/2" - 36-1/2"	38-1/2"	80"	79-3/4" - 80-1/2"	81-9/16"
	36"	35-1/2" - 36-1/2"	38-1/2"	96"	95-3/4" - 96-1/2"	97-9/16"
	72"	71-5/8" - 72-11/16"	74-11/16"	80"	79-3/4" - 80-1/2"	81-9/16"
Arcada Patio	72"	68-1/4" - 75-1/4"	77-1/4"	80"	78-5/8" - 82"	84"
ArcadaMAX	36"	35-1/2" - 36-1/2"	38-1/2"	80"	79-3/4" - 80-1/2"	81-9/16"
	72"	71-5/8" - 72-11/16"	74-11/16"	80"	79-3/4" - 80-1/2"	81-9/16"
ArcadaMAX Patio	72"	68-1/4" - 75-1/4"	77-1/4"	80"	78-5/8" - 82"	84"
Cottage Rose	30"	29-1/2" - 30-1/2"	32-1/2"	80"	79-3/4" - 80-1/2"	81-9/16"
	32"	31-1/2" - 32-1/2"	34-1/2"	80"	79-3/4" - 80-1/2"	81-9/16"
	36"	35-1/2" - 36-1/2"	38-1/2"	80"	79-3/4" - 80-1/2"	81-9/16"
	36"	35-1/2" - 36-1/2"	38-1/2"	96"	95-3/4" - 96-1/2"	97-9/16"
	60"	59-5/8" - 60-11/16"	62-11/16"	80"	79-3/4" - 80-1/2"	81-9/16"
	72"	71-5/8" - 72-11/16"	74-11/16"	80"	79-3/4" - 80-1/2"	81-9/16"
Del Flor	32"	31-1/2" - 32-1/2"	34-1/2"	80"	79-3/4" - 80-1/2"	81-9/16"
	36"	35-1/2" - 36-1/2"	38-1/2"	80"	79-3/4" - 80-1/2"	81-9/16"
La Entrada	36"	35-1/2" - 36-1/2"	38-1/2"	80"	79-3/4" - 80-1/2"	81-9/16"
Meridian	36"	35-1/2" - 36-1/2"	38-1/2"	80"	79-3/4" - 80-1/2"	81-9/16"
Solana	36"	35-1/2" - 36-1/2"	38-1/2"	80"	79-3/4" - 80-1/2"	81-9/16"
	36"	35-1/2" - 36-1/2"	38-1/2"	96"	95-3/4" - 96-1/2"	97-9/16"
	72"	71-5/8" - 72-11/16"	74-11/16"	80"	79-3/4" - 80-1/2"	81-9/16"
Su Casa	30"	29-1/2" - 30-1/2"	32-1/2"	80"	79-3/4" - 80-1/2"	81-9/16"
	32"	31-1/2" - 32-1/2"	34-1/2"	80"	79-3/4" - 80-1/2"	81-9/16"
	36"	35-1/2" - 36-1/2"	38-1/2"	80"	79-3/4" - 80-1/2"	81-9/16"
	36"	35-1/2" - 36-1/2"	38-1/2"	96"	95-3/4" - 96-1/2"	97-9/16"
Su Casa Patio	60"	56-1/4" - 63-1/4"	66-1/4"	80"	78-5/8" - 82"	84"
	72"	68-1/4" - 75-1/4"	77-1/4"	80"	78-5/8" - 82"	84"
	96"	92-1/4" - 99-1/4"	101-1/4"	80"	78-5/8" - 82"	84"
El Dorado	36"	35-1/2" - 36-1/2"	39"	80"	79-3/4" - 80-3/8"	81-5/8"
*Guardian	36"	35-1/4" - 36-1/4"	39"	80"	79-7/8" - 80-1/2"	81-9/16"
*Lexington	36"	35-1/2" - 36-1/2"	38-1/2"	80"	80-3/8" - 81"	81-3/16"
*Solstice	36"	35-1/2" - 36-1/2"	38-1/2"	80"	80-3/8" - 81"	81-3/16"
*Pima	36"	35-1/4" - 36-1/4"	39"	80"	79-7/8" - 80-1/2"	81-9/16"
*Sylvan	36"	35-1/4" - 36-1/4"	39"	80"	79-7/8" - 80-1/2"	81-9/16"

\* Note: Door includes bottom bar. Measurement does **NOT** include the bottom bar.

# RECESSED MOUNT

## Fit Range - Standard Sizes

Some models are available in custom sizes. See a Home Depot associate and ask to look at options in the MyCD system.

Model	Call Size	Rough Opening Fit Range	Overall Frame Size	Call Size	Rough Opening Fit Range	Overall Frame Size
	Width			Height		
<b>Waterford</b>	32"	31-3/4" - 32"	33-1/2"	80"	81-3/16" - 81-5/8"	82"
	36"	35-3/4" - 36"	37-1/2"	80"	81-3/16" - 81-5/8"	82"
<b>Coventry</b>	36"	35-3/4" - 36"	37-1/2"	80"	81-3/16" - 81-5/8"	82"
<b>Arbor</b>	32"	31-3/4" - 32"	33-1/2"	80"	81-3/16" - 81-5/8"	82"
	36"	35-3/4" - 36"	37-1/2"	80"	81-3/16" - 81-5/8"	82"
<b>Estate</b>	30"	29-3/4" - 30"	31-1/2"	80"	81-3/16" - 81-5/8"	82"
	32"	31-3/4" - 32"	33-1/2"	80"	81-3/16" - 81-5/8"	82"
	36"	35-3/4" - 36"	37-1/2"	80"	81-3/16" - 81-5/8"	82"
<b>Estate Fleur-de-lis Lone Star Moorish Lace Paladin Watchman Duo</b>	28"	27-3/4" - 28-1/16"	29-5/16"	80"	80-3/4" - 81-1/8"	82-7/16"
	30"	29-3/4" - 30-1/16"	31-5/16"	80"	80-3/4" - 81-1/8"	82-7/16"
	32"	31-3/4" - 32-1/16"	33-5/16"	80"	80-3/4" - 81-1/8"	82-7/16"
	34"	33-3/4" - 34-1/16"	35-5/16"	80"	80-3/4" - 81-1/8"	82-7/16"
	36"	35-3/4" - 36-1/16"	37-5/16"	80"	80-3/4" - 81-1/8"	82-7/16"
<b>Rambling Rose</b>	36"	35-3/4" - 36-1/16"	37-5/16"	80"	80-3/4" - 81-1/8"	82-7/16"

**Custom sizes available  
in select models  
See Sales Associate  
for details**