

INSTALLING FAN/BLOWER ACCESSORY MODEL BMGB100-BK

For factory installed blower kits refer to page 2 of this instruction sheet for thermostat bulb relocation.

DISCONNECTING WALL MOUNTED HEATER

Wall mounted heater must be disconnected from gas supply and removed from wall before installing fan accessory. Contact a qualified service person to do this. Follow all codes.

REMOVING PANEL FROM BACK OF HEATER

If your heater has a knock-out panel, insert a flat screwdriver into the hole in the panel and remove panel to the outside of the heater (see Figure 1). If your heater has an installed panel, remove panel with a Phillips head screwdriver (see Figure 1).

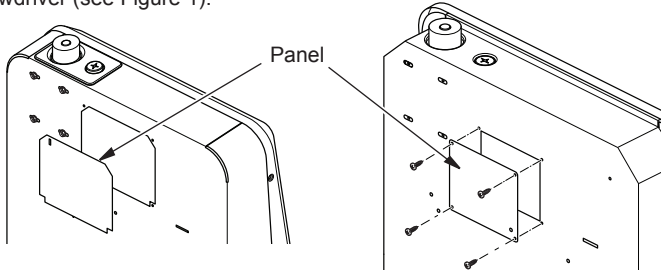

Figure 1

ATTACHING FAN/BLOWER ASSEMBLY

1. Attach fan/blower to the rear panel of the heater using the four screws provided (see Figure 2).
2. Remove front panel assembly from heater (see your heater owner's manual).
3. Attach thermostat switch to top of fan/blower using 2 screws (see Figure 3). Replace front panel assembly

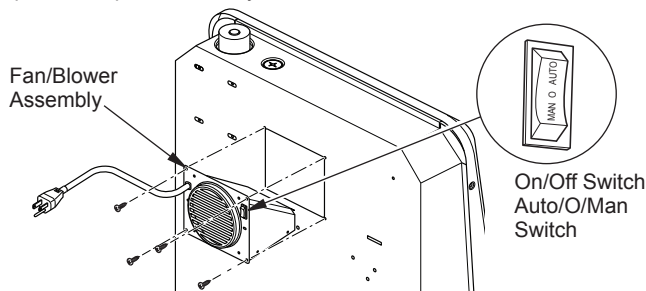

Figure 2

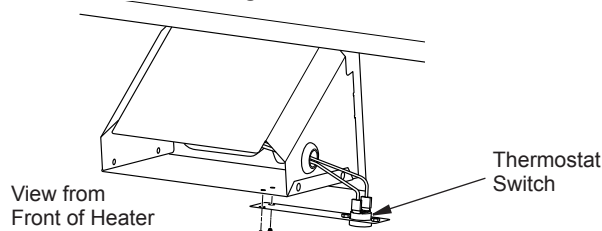

Figure 3

FAN OPERATION

To operate in Manual mode, turn on/off switch to the ON position. To operate in Automatic mode turn AUTO/O/MAN to the desired position, Man position will remain constantly on. Auto position will be controlled by the sensor on fan blower unit. To stop the operation, turn unit switch to the O position (see Figure 2).

ELECTRICAL CONNECTION

⚠ Do not use this fan/blower if any part of it has been under water. Immediately call a qualified service technician to inspect the fan/blower and replace any part of the electrical system which has been under water.

This fan/blower accessory must be grounded. This unit comes with a 3-prong grounding plug for your protection against electrical shock. Use standard, 3 holes, grounded outlet. If an extension cord is needed it must have a 3 prong plug and a 3 hole receptacle. An undersized cord will cause a drop in live voltage and could result in loss of power and overheating.

GROUNDING INSTRUCTIONS

This fan/blower is for use on 120 volts. The cord has a plug as shown at A in Figure 4. An adapter as shown at C is available for connecting three-blade grounding-type plugs to two-slot receptacles. The green grounding lug extending from the adapter must be connected to a permanent ground such as a properly grounded outlet box. The adapter should not be used if a three-slot grounded receptacle is available.

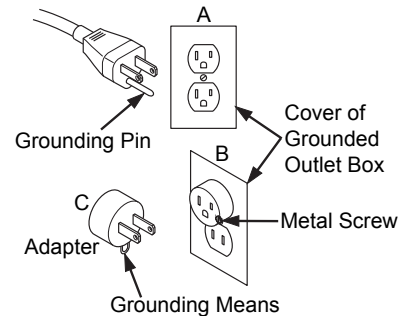

Figure 4

FAN OPERATION

To operate the manual unit, turn ON/OFF switch to the ON position. To operate the Automatic unit, turn AUTO/O/MAN switch to the desired position. MAN position will remain constantly on. AUTO position will be controlled by the sensor on the fan blower unit. The sensor will be activated when the temperature of the sensor head reaches the set point of the switch after the heater is started. To stop the operation, turn the switch to the O position.

ELECTRICAL WIRING

Any electrical re-wiring of this appliance must be done by a qualified electrician. This wiring must be done in accordance with local codes and/or in Canada with the current *CSA C22.1 Canadian Electrical Code*, and for US installations, the *National Electrical Code ANSI/NFPA NO 70*.

⚠ WARNING: If repairing or replacing any electrical component or wiring, the original wire routing, color coding and securing locations must be followed.

⚠ CAUTION: Label all wires prior to disconnection when servicing controls. Wiring errors can cause improper and dangerous operation.

⚠ WARNING: Never attempt to service fan/blower while it is plugged in, operating, or hot. Burns and electrical shock could result. Only a qualified service person should service or repair fan/blower.

Verify proper operation after servicing. If any of the original wire as supplied with the appliance must be replaced, it must be replaced with a wire of at least a 105° C temperature rating.

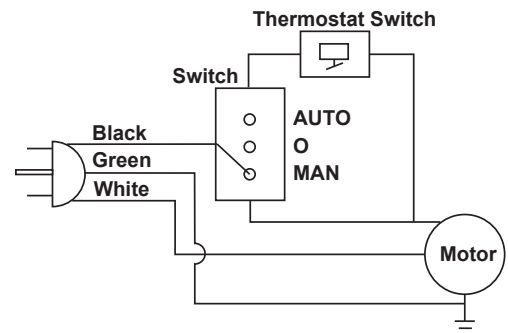

Figure 5

THERMOSTAT BULB RELOCATION

For 20,000 and 30,000 BTU/HR Blue Flame Heaters with Blower Installed Only

1. Remove thermostat sensing bulb from the shipping position.
2. Locate the two bulb clips in the hardware package and remove the paper backing.
3. Place thermostat bulb inside the clips, then place in approximate location shown in Figure 6.
4. Press firmly to adhere clip to the heater cabinet.

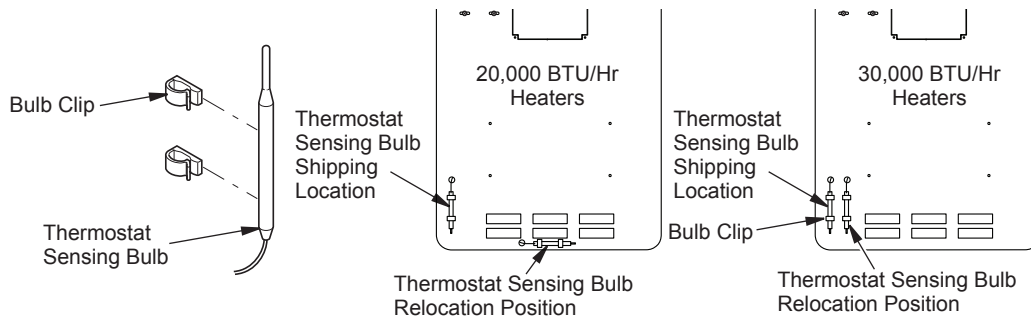

Figure 6 - Moving Thermostat Sensing Bulb Blue Flame Heaters Only

For 2 and 3 Plaque Heaters with Blower Installed Only

1. Remove thermostat sensing bulb from the shipping position.
2. Locate the two bulb clips in the hardware package and remove the paper backing.
3. Place thermostat bulb inside the clips, then place in approximate location shown in Figure 6.
4. Press firmly to adhere clip to the heater cabinet.

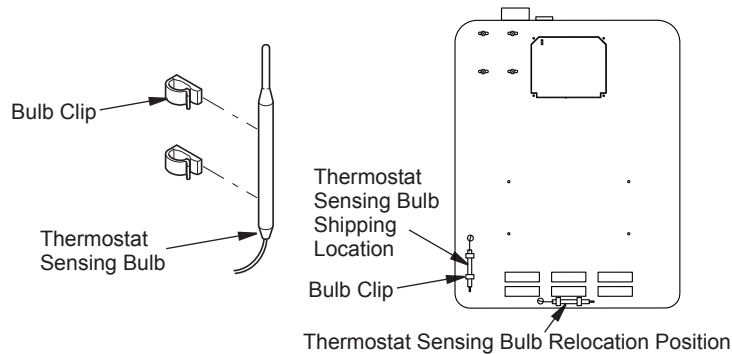

Figure 7 - Moving Thermostat Sensing Bulb Infrared Heaters Only

BLUEGRASS
Living

Bluegrass Living, Inc.
Bowling Green, KY 42101

200285-07
Rev. A
06/19