

# iSpring CRO2000

## Installation Instructions & User Manual

Ver. 11/2023

### Important User Information

Users must adhere to the installation specifications described in this Product Installation and Operation Manual (hereinafter referred to as the "instruction manual"). iSpring Water Systems LLC (Hereinafter referred to as "iSpring") is not responsible for damage, loss, or injury resulting from neglect, improper maintenance, or unauthorized modification of the unit.

- This product is designed for residential and light commercial use ONLY. Contact iSpring customer service to inquire about use in any other environment or setting.
- The operating temperature range is 41°F - 100°F. When the water temperature or ambient temperature falls below 41°F, shut off the inline water supply, and drain the remaining water from the system. Failure to do so may result in malfunction, damage, and possible injury to the enclosure or water supply line.
- If leaking occurs, immediately shut off the inline water supply. Then unplug the system and contact iSpring customer service at 678-261-7611 from 9:00 a.m. to 5:00 p.m., Monday – Friday, or open an online ticket 24/7 at [support.123filter.com](https://support.123filter.com).
- Only use authorized iSpring parts and filters. Using unauthorized or aftermarket components will void the product warranty.
- iSpring recommends that users regularly check external fittings and connections to ensure all components are secure and there are no leaks.
- Unauthorized modification or disassembly is strictly prohibited and will void the warranty.

### Product Specifications

Model	CRO2000
Scope and Intended Use	This system is designed for use with municipal water in residential and light commercial applications.
Inlet Water Temperature	41 - 100 °F
Inlet Water Pressure	40 - 70 psi
Connector Sizes	inlet: 3/4", outlet/drain: 3/8"
Maximum Pure Water Flow	Up to 2000 GPD (1.4 GPM)
Overall Dimensions (h*w*d)	38.6" x 27.8" x 15.2"

## Pressure Gauge Definitions

Left pressure gauge: Indicates inlet water pressure.

Right pressure gauge: Indicates the water pressure at the inlet of the RO membrane, suggesting the condition of the pre-filters.

**!** Note: Replace the pre-filters if there is a significant drop in the reading of the right pressure gauge.

## Water Treatment Process

Municipal Tap Water → PP Sediment Filter → CTO Carbon Block Filter → Reverse Osmosis Membrane → Pure Water

### Packing List and Components



Figure 1. Overall Dimensions

No.	Component	No.	Component
1	Machine Head	8	PP Sediment Filter (Model: FP25B)
2	RO Membrane Housing	9	CTO Carbon Block Filter (Model: FC25B)
3	Frame Pillar		
4	Frame Base	10	1000 GPD Reverse Osmosis Membrane (Model: MCRO1000)
5	Omni Wheel		
6	Housing Wrench	11	Water Inlet/Outlet Tube Assembly
7	Pre-Filter Housing	12	User Manual

No.	Component	No.	Component
13	M6*50 Screw Set	17	PE Tube
14	M6*14 Screw	18	Zip Tie
15	M8*45 Screw Set	19	Lubricator Pack
16	Housing O-rings	20	Plumber's Tape

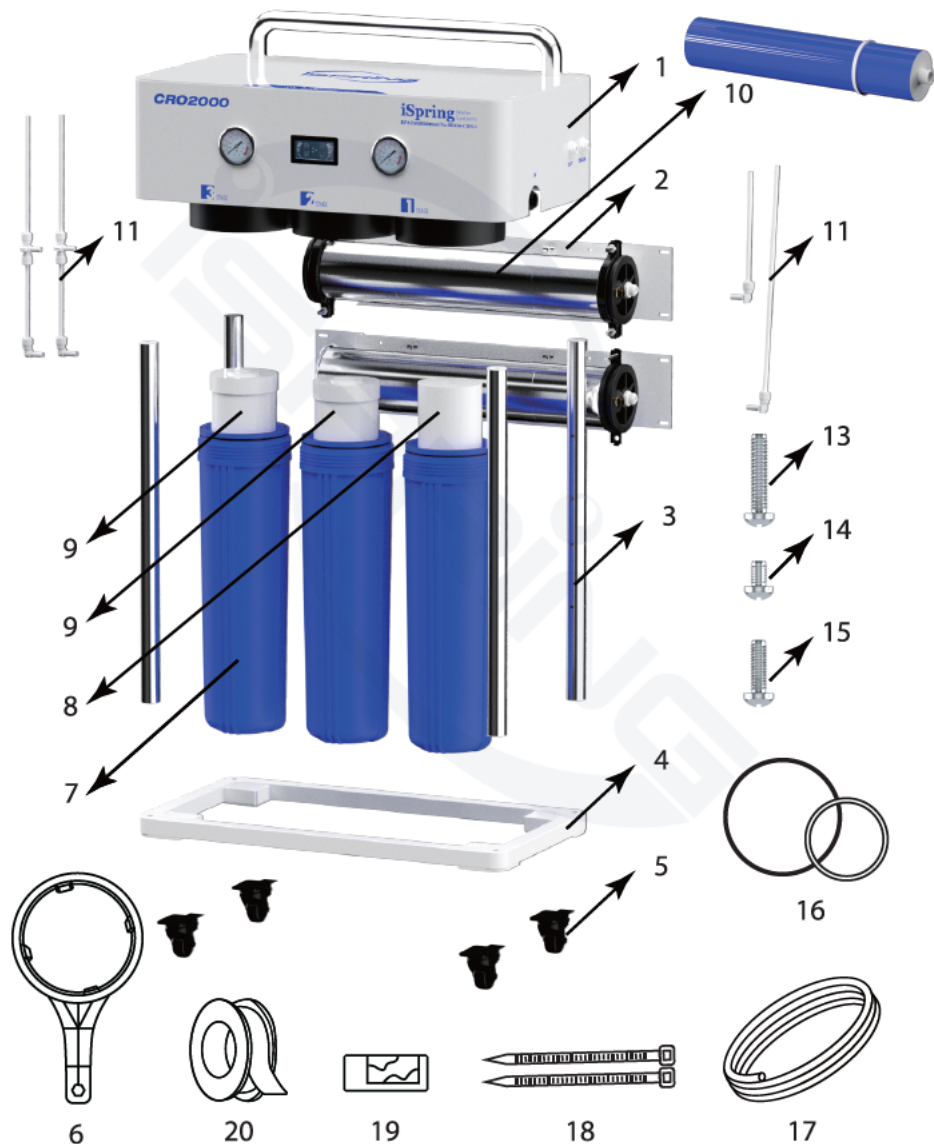

Figure 2.

# Product Assembling and Installation

## Before Installation

- Ensure there is enough space at the desired location for the system and for safe filter replacement. Keep in mind that contaminated water will be discharged through the drain line, please take this into account.
- Verify no parts are missing from the package. Contact iSpring if any part is missing or defective.
- Tools required for assembly:

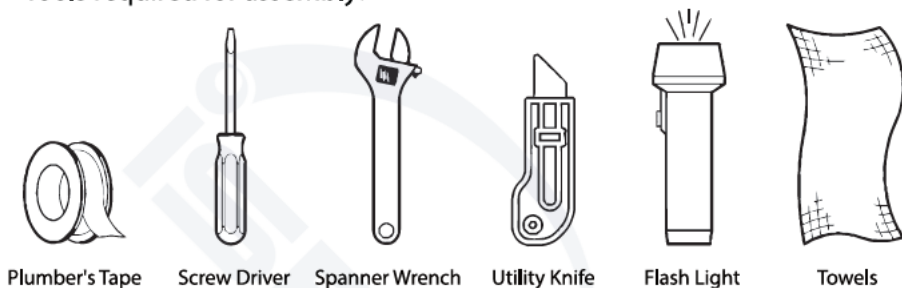
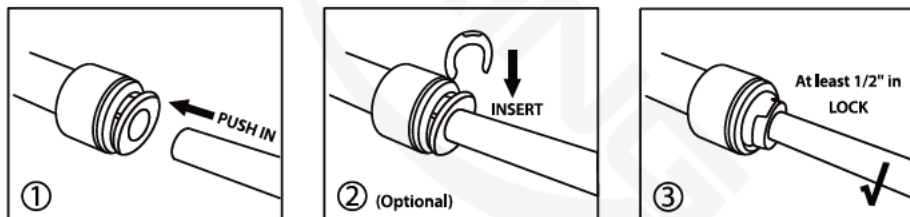

Figure 3. Recommended Tools

## How to install 1/4" and 3/8" Quick Fitting

### HOW TO CONNECT



### HOW TO DISCONNECT

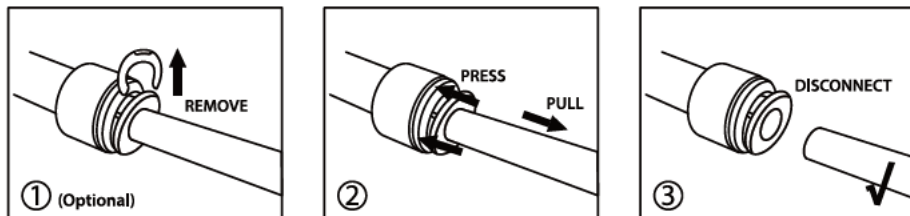
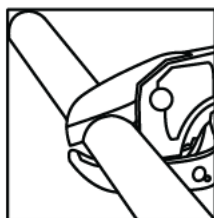

Figure 4.

## ■ How to Use the Push to Connect Fittings

### HOW TO CONNECT



**Step 1:**  
Make a clean and square cut with a pipe cutter.

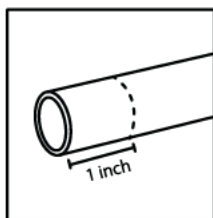

**Step 2:**  
Mark the pipe with 1 inch insertion depth.

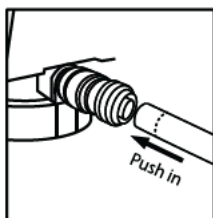

**Step 3:**  
Insert the pipe into the fitting.

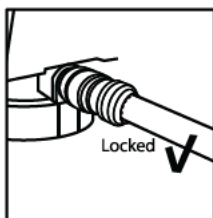

**Step 4:**  
Check the insertion depth mark.

### HOW TO DISCONNECT

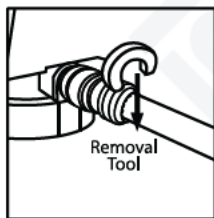

**Step 1:**  
Snap the removal tool over the pipe and align next to the fitting.

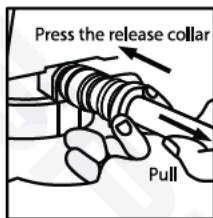

**Step 2:**  
Firmly push the removal tool over the collar of the fitting.

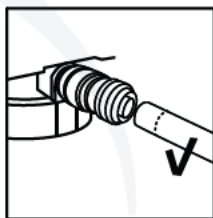

**Step 3:**  
Pull the pipe out of the fitting.

Figure 5.

## ■ Installation

1. Lean the system sideways with the screen facing upwards. (Use the packaging card boxes as cushions to avoid scratches). Screw the frame pillar clockwise into the machine head as shown in Figure 6.

**!** Note: Ensure that the frame pillar with holes is positioned at the rear, and the pillars without holes are placed at the front of the frame. When the pillars are tightened, the holes should face directly front and rear. If they do not, continue tightening or slightly loosening the rear pillars until they are aligned. Membrane housings will be mounted on these holes in later steps, making it crucial to ensure the holes are correctly positioned.



Position the frame pillar with holes at the rear, ensuring that the holes are facing directly towards the rear.

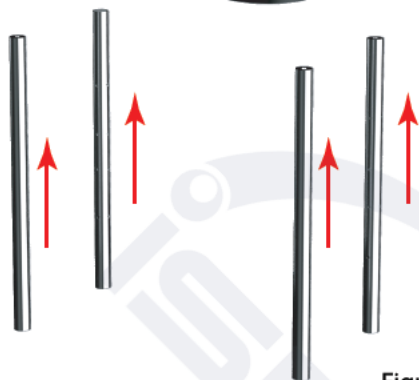

Figure 6.

attach the frame base to the frame pillars from the bottom, as shown in Figure 7.

**!** Note: Ensure that the screws are securely tightened to support the weight of the entire system.



M8\*45 screw  
+ M8 washer

Figure 7.

3. Use the M6\*14 screws to attach the omni wheels to the frame base as shown in Figure 8.

⚠ Note: Ensure that the screws are securely tightened to support the weight of the entire system.

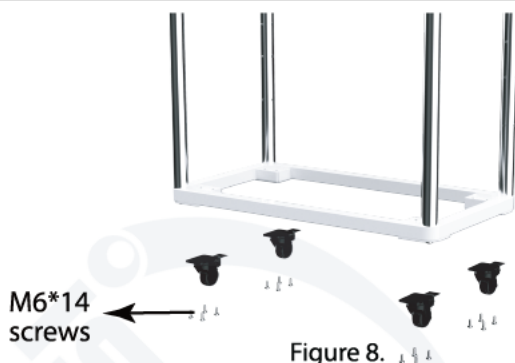

4. Open the membrane housing cap at the water inlet end and insert the RO membrane. Please pay attention to the direction marked on the membrane housing as well as the reverse osmosis membrane. **The membrane will not be functional if installed backwards. Ensure the membrane housing is sealed tightly.**

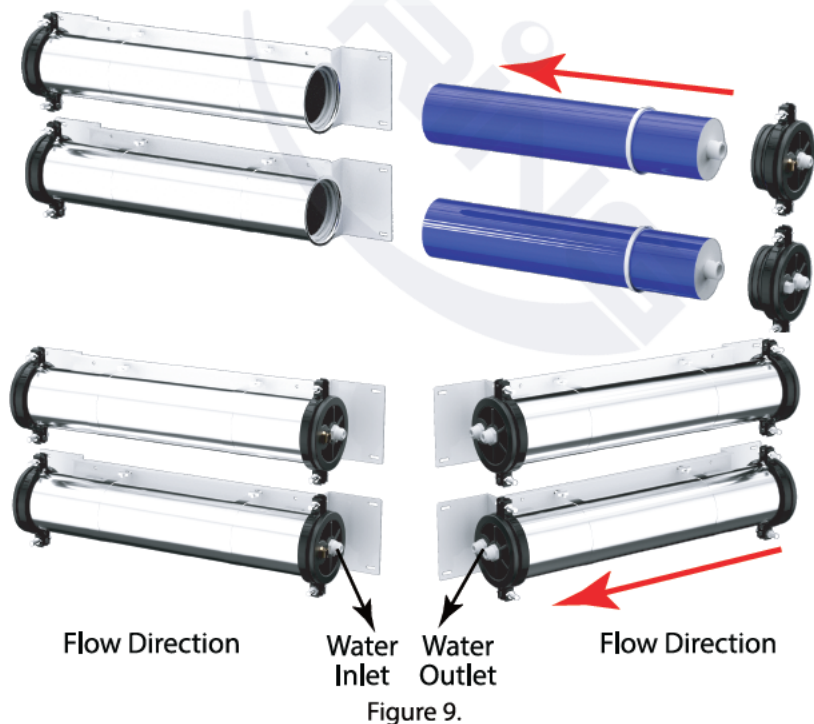

5. Using M6\*50 screws with nuts and washers to attach the membrane housings to the rear frame pillars, as shown in Figure 10. Ensure the screws are tightened.

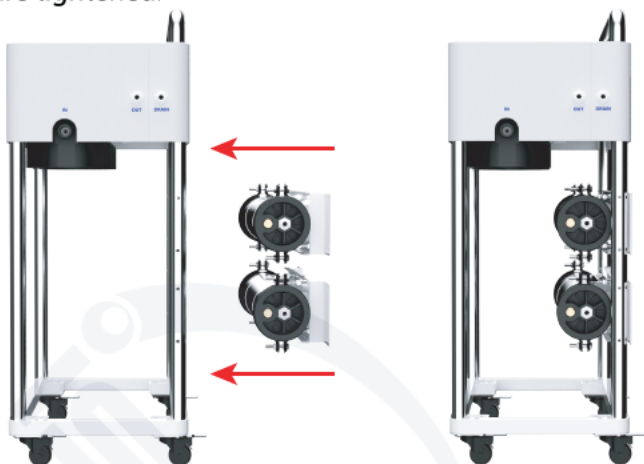

Figure 10.

6. Remove the plastic wrap on the filter cartridges. Insert the filter cartridges into the filter housing as shown in Figure 11. and screw the filter housings onto the filter housing caps.



Figure 11.

7. Connect the left and right sides of the machine head to the RO membrane using the pre-assembled fitting and tubing, as shown in Figures 12. The set includes a 3/8" elbow quick fitting.

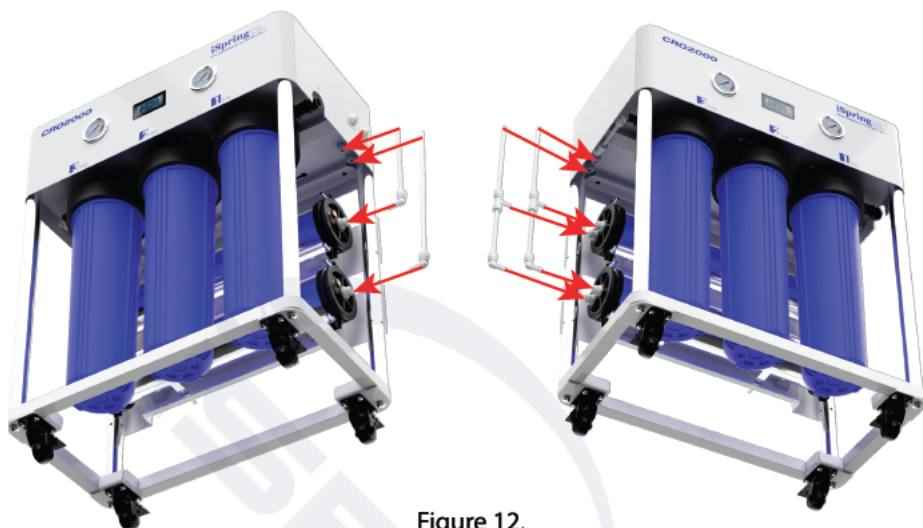

Figure 12.

8. The system assembly is now complete. Connect the water supply line to the port marked "IN" (3/4" push-to-connect fitting). Also, attach the filtered water outlet marked "OUT" (3/8" quick fitting) to your desired line to the port marked "DRAIN" by for use.







Figure 13.

## Using the System

### Initial System Settings

Turn on the water supply and plug in the power adapter. The system will begin operating 2 seconds after powering up. It automatically flushes for 18 seconds, indicated by a single beep. The system's operating status is displayed on the front panel, as shown below.

	Operations and Functions
 RINSE	<p>(1) Re-powering On: The system performs auto-rinsing for 18 seconds.</p> <p>(2) The system performs an 18-second auto-rinsing every 6 hours.</p> <p>(3) Once the inlet water pressure resumes regular operation after water shortage, the system performs auto-rinsing for 18 seconds.</p> <p>(4) Automatically flushing for 18 seconds after turning off the water or the water tank is full when hooked up with a tank (flushing after the water is full is triggered only after cumulative water production has exceeded 60 seconds.)</p>
 PURIFY	The booster pump starts working, water inlet solenoid valve is open, and the pure water production in progress.
 OFF	When the incoming water is turned off or the tank is full, the machine stops working and the water inlet solenoid valve is shut off.
 LOW	Water shortage: When the inlet washer pressure is too low, the machine stops working. The booster pump stops, the water inlet solenoid valve closes, and the system will beep for 10 seconds.
 SVC.	Timeout protection for continuous pump operation: When the system has run continuously for more than 6 hours (during which the water was not turned off). The system will enter protection mode and will shut off automatically, The system will beep 10 times. Unplug the power and plug it back to resume using the system.

## Filter Changing Schedule

Filter	Changing Frequency
PP Sediment Filter	Up to 6 months
CTO Carbon Block Filter	Up to 12 months
RO Membrane	Up to 3 years

### Daily Maintenance

- Replacing the filter cartridges: The filter should be replaced regularly to ensure effective filtration and that the water output meets the reference standard. Consider replacing the filters in the following situations:
  - a. The TDS (Total Dissolved Solids) level of the purified water has increased significantly, or there is an unpleasant taste in the water.
  - b. There is a significant reduction in water flow rate, without any change in water temperature and inlet water pressure.  
Note: Lower inlet water pressure and lower temperature will result in a reduced flow rate.
- If this product will not be in use for a long time, please turn off the power supply and water inlet ball valve. When using it again, it should be flushed for 3-5 minutes before normal use.

Any questions?  
Scan the QR code  
for support.





Like our products?

Please show your support by writing a product review on the marketplace where you make your purchase. Even just a quick statement means a lot to us.

Thank you!

**iSpringFilter.com**



Scan to get your **FREE** warranty

For questions, comments, or technical support, please contact us at:

✉ [support@123filter.com](mailto:support@123filter.com)

☎ +1 (678) 261-7611

☎ +1 (470) 560-0012

Monday-Friday 9:00 a.m. - 5:00 p.m. EST

**Water's Good<sup>®</sup>**