

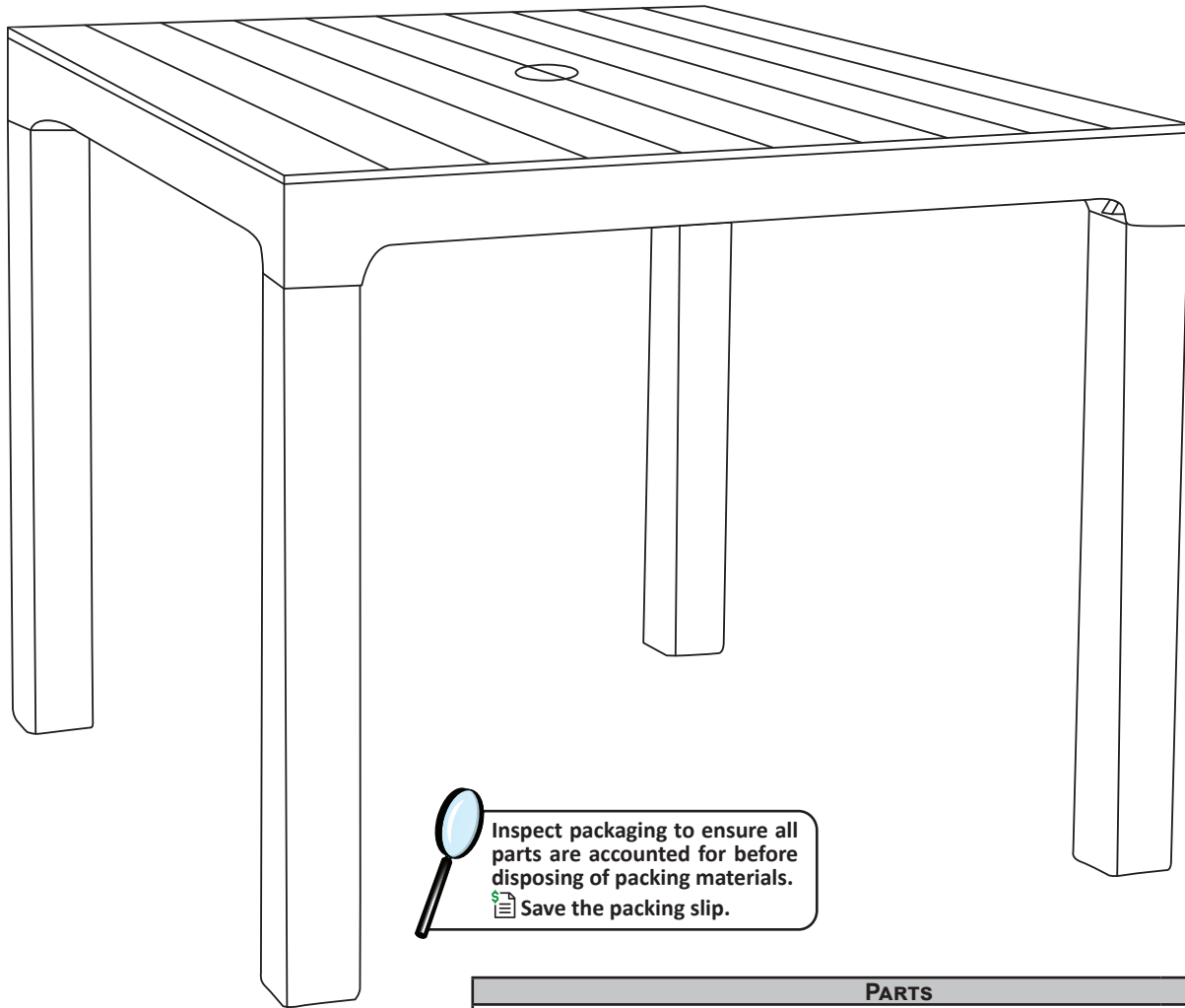



Thank you for choosing Sunnydaze Decor. We stand behind our brand and the quality of the items we sell. Replacement parts or products will be sent at our discretion within the 1-year warranty period. Proof of purchase, with the date of purchase as well as photos of the merchandise defect, must be provided. Photos are used to determine the cause of defects and for future quality control. Register your warranty at <https://tiny.cc/SunnydazeWarranty>. If you have any questions, comments or concerns, feel free to contact us by phone at 833-982-1977, by email: [customerservice@sunnydazedecor.com](mailto:customerservice@sunnydazedecor.com), or via our contact us page at <https://tiny.cc/SunnydazeContact>

# POLYPROPYLENE TABLE WITH FAUX WOODGRAIN TOP SUP-363

Review all assembly and care information before using this product. Save this manual for future reference.  
**Assemble components on a soft, clean surface to avoid damaging the finish.**

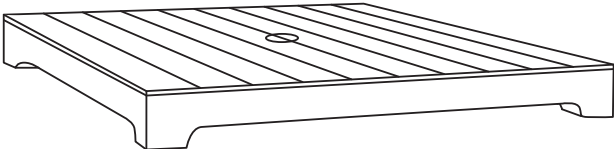

 Inspect packaging to ensure all parts are accounted for before disposing of packing materials.  
 Save the packing slip.

PARTS		QTY.
	Tabletop	1
	Leg	4

## WARNING:

Manufacturer and seller expressly disclaim any and all liability from personal injury, property damage or loss, whether direct or indirect, or incidental, resulting from the incorrect attachment, improper use, inadequate maintenance, or neglect of this product.

# ASSEMBLY

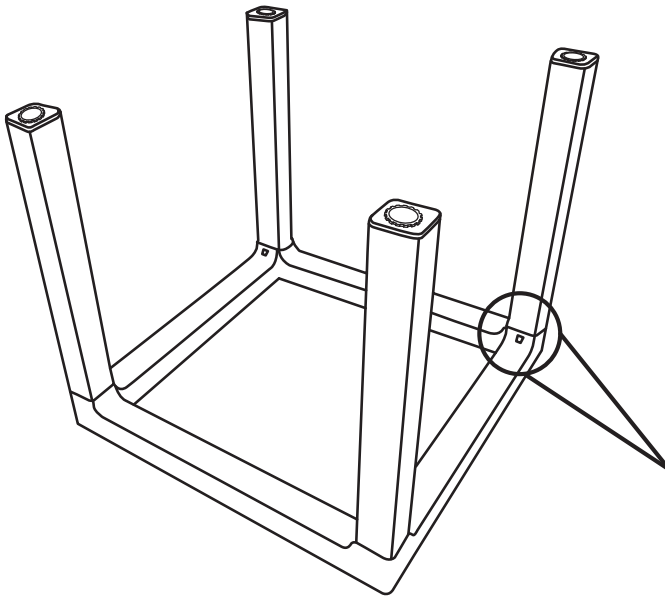

1. Lay the tabletop face down on a soft, clean surface.
2. Ensure the tab on each leg aligns with the opening on the corners of the tabletop. Then, firmly push the leg into the corner of the tabletop until the tab on the leg clicks into place.
3. After all legs have been secured, flip the table upright. If necessary, twist the leveling feet to level the table.

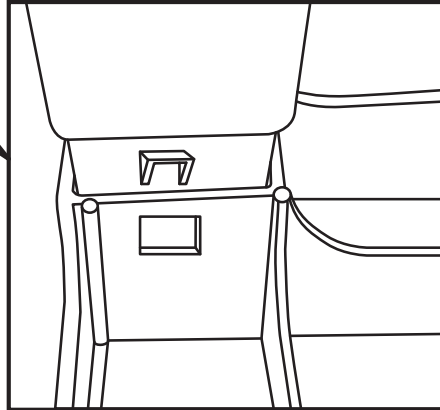

## **IMPORTANT:**

Ensure the legs are installed in the correct direction. The table is designed for 1-time assembly; components may crack or break if unit is disassembled.

# CARE & MAINTENANCE

**SAFE USE:** Never sit or stand on the table. Do not exceed the weight capacity of the table. Do not place hot items directly on the table surface.

**COVER:** When not in use, cover the table with a breathable cover to help protect it from dust build-up, collecting debris, and the effects of long-term sun exposure.

**WINTER CARE & STORAGE:** Protect this item from inclement weather, especially high winds, hail, ice and snow. Move the table to a dry, indoor location. Cover the table while in storage to help prevent dust build-up.

# CLEANING

***Do not use harsh chemicals or abrasive materials to clean the table.***

 **DO NOT USE BLEACH**

 **DO NOT USE A PRESSURE WASHER**

Remove loose dust and debris with a soft, dry cloth.

Mix mild soap with warm water and wash the table using a soft cloth. Thoroughly rinse soap residue off the table.

Dry with a soft, lint-free cloth to prevent water spots.

**Any modification to the product or failure to follow recommended care will void the product warranty.**

*If you experience issues with assembly or the product was damaged during shipping, please contact our customer service team through one of the methods mentioned at the top of page 1.*

*Please have the item number and order information ready to expedite response time.*

## **WARNING:**

Manufacturer and seller expressly disclaim any and all liability from personal injury, property damage or loss, whether direct or indirect, or incidental, resulting from the incorrect attachment, improper use, inadequate maintenance, or neglect of this product.