



***Owner's Manual***

***E-Urban Pro***



Please visit our YouTube channel for the assembly guide video.



For any assembly-related questions, please call (888) 933-8899.

## **THANK YOU FOR CHOOSING A YOUNG ELECTRIC BICYCLE!**

Young Electric E-Urban Pro E-Bike will provide power, stability, and enjoyment that can be ridden on various terrains and taken just about anywhere. Its lightweight, compact, folding design allows for convenient storage and travel. The E-Urban Pro is equipped with a powerful front hub motor and maintenance free internal gear rear hub. This bike was designed with quality, safety, pleasure, and convenience in mind.

Young Electric E-Urban Pro E-Bikes are designed by our Research & Development team located in Milwaukie, Oregon. This team consists of all senior engineering and customer service staff with a passion for the industries they serve. They are focused on developing products that match the requirements of different cycling enthusiasts and are committed to a standard of excellence in quality, efficiency, affordability, and customer service.

**It is extremely important to keep or record your E-Bike's serial number to activate your product warranty.**

**TABLE OF CONTENTS**

Using this Manual..... 4

Safety Information and Warnings..... 5

Overview, In the Box, Specifications.....15

Assembly Instructions .....19

Start-Up Procedure.....31

Battery Charging, Use & Storage Information ..... 32

HMI Display & PAS Remote ..... 39

Adjustments..... 51

Maintenance, Cleaning & Storage.....57

Troubleshooting..... 65

Service Parts..... 68

Warranty & Registration..... 70

## USING THIS MANUAL

### NOTICE

Young Electric is not liable for accidents or injuries due to improper use of the product, failure to adhere to the instructions given in this guide, or modifications to the product. While every effort has been made to ensure that the information contained in this guide is accurate and complete, Young Electric is not liable for any errors or omissions.



Keep this Owner's Manual in a safe place for future reference. All content in this manual is subject to change as we continually work to refine our products. Visit [youngelectricbikes.com](http://youngelectricbikes.com) for latest version. Please read this manual completely before assembling and riding your bike. It will give you information necessary for adjusting, maintaining, and effectively using your bike. This manual is a guide only and not a complete or comprehensive manual.

If you have any questions after reading this manual, please contact us at [cservice.fus@youngelectricbikes.com](mailto:cservice.fus@youngelectricbikes.com) or 888-332-8582 / 888-933-8899.

Your first assembly and adjustment require tools included with your bike. We recommend that you use an Authorized Service Center, or a certified, reputable bike mechanic when possible. The risks associated with the use of this bike are the sole responsibility of the rider. Young Electric is not liable for accidents or injuries due to improper use of the product, failure to adhere to the instructions given in this manual, modifications to the product, or unforeseen situations or conditions that occur while riding this bike.

## **SAFETY INFORMATION & WARNING**

The following safety signal words indicate the following information is a safety message. The symbols are to alert you to potential hazards.

<b>NOTICE</b>
Indicates information that the user should pay special attention to but is not related to physical injury.
 <b>CAUTION</b>
Indicates a hazard or unsafe condition that could result in minor injury if the user fails to read, understand, and follow the safety information provided.
 <b>WARNING</b>
Indicates a hazard or unsafe practice that can result in severe injury or death if the user fails to read, understand, and follow the safety information provided.

 <b>WARNING</b>
Failure to pay attention to safety messages may result in property damage, injury, or death.

 **WARNING**

**All users must read and understand this manual before using their bike. Ensure that you understand all instruction, cautions and warnings. Failure to adhere to these safety notes can lead to severe injury or death.**

 **CAUTION**

**Correct assembly and set up of your bike before first ride are extremely important. It is important to check the condition of bike and tighten regularly. Always do a mechanical safety check before riding. Ensure the bike fits you properly before your first use. If your bike is not the correct size, you may lose control of it. Proper size allows for no less than one inch clearance between top tube of bike and ground plane, and the crotch of rider.**

 **WARNING**

**Do not ride bike until you have adequate knowledge of its controls and operation, power control system, throttle mechanism and pedal assistance feature. Damage caused by failing to follow instructions voids warranty and may cause dangerous situations, accidents, injury, damage to bike or property, or death.**

## **WARNING**

- **Engaging in extreme riding is not recommended or permitted. Extreme riding can cause severe injury or death. Extreme riding can damage bike components, which have strength and integrity limitations. This can also cause or lead to injury or death.**
- **After any incident, your bike should be considered unsafe to ride until you consult with a qualified bike mechanic for a comprehensive inspection.**
- **Failure to perform and confirm proper installation, compatibility, proper operation, or maintenance of any component or accessory can result in severe injury or death.**
- **To avoid a hazardous situation, it is imperative to properly charge, store, and use your battery. Failure to do so can be extremely harmful and also void the warranty.**
- **Ensure good condition and proper installation of handlebar grips to prevent loss of control and/or fall.**
- **All frames and components should be regularly checked for signs of wear and/or breakage (cracks, corrosion, breaks...) These are important safety verifications to avoid accidents, injuries and enable your bike to last and give you pleasure.**
- **Do not disassemble, modify, or replace electrical parts.**
- **Reflectors and the bell are for your safety, do not remove.**
- **Do not use this product with standard bike trailers, stands, vehicle racks, or accessories not approved by Young Electric as safe and compatible. Any aftermarket changes to your Young Electric bike not expressly approved by Young Electric could void the warranty and create an unsafe riding experience.**

## CAUTION

- **Use caution riding in rain; breaking distance increases, and visibility and adherence are reduced. When riding at night or in harsh weather, wear reflective clothing and check your bike's lighting and reflectors. In wet conditions, feet or hands can slip and lead to severe injury or death. Ensure your bike is fitted with reflectors.**
- **Off-road riding presents variable conditions and hazards. Always wear appropriate safety gear. Do not ride alone in remote areas. Follow local rules/regulations.**
- **Ensure understanding of the throttle and pedal assistance sensor before using the bike with respect to travel at speeds appropriate for the usage area, riding conditions, and user experience level.**
- **Use extreme care when using the pedal assistance sensor and throttle. Be ready for power assistance to engage as soon as pedaling is underway. Always start with lowest assist level and increase only when you feel comfortable and confident to do so.**
- **Check the operation of the brake motor cutoff switches before riding.**
- **E-Bikes are heavier and faster than normal bikes and require extra caution while riding.**
- **It is your responsibility to follow the laws and requirements of operating this product in the area where you ride.**
- **Always ride single file and always look out for dangerous situations.**
- **Never ride with headphones on or with personal radios.**
- **Always gently apply rear brake first, then front brake, to avoid brakes locking up.**



## WARNING

**For your protection ALWAYS WEAR A HELMET when riding a bike to prevent severe head injury or death.**

### Helmets

- Make sure helmet has a certification sticker from the U.S. Consumer Product Safety Commission (CPSC) inside it. Follow manufacturer's directions.
- Always wear an approved bicycle helmet that fits well.
- Your helmet must fit properly and be worn correctly. Ensure the helmet covers the head snug, level, and stable.
- Always keep the chin strap securely buckled and ensure it is in good condition.

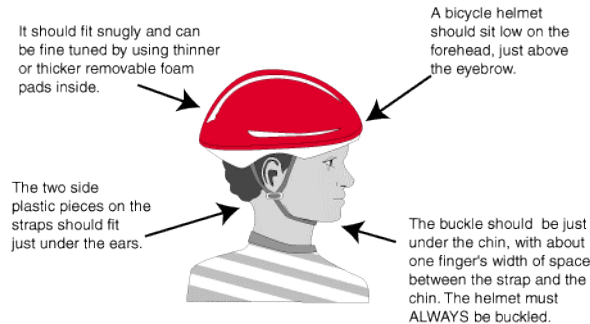

**For a final check**, gently try to roll the helmet back and forth on the head. The helmet should not move more than 1/2 inch in any direction.

## Apparel

- Never ride barefoot or with shoes that slide off easily. Wear shoes that grip the pavement and the pedals well.
- For hand comfort and protection, cycling gloves are helpful.
- Wear visible clothing. At night, reflective clothing is recommended.
- Riding off-road at night is not recommended.
- Wear protective eyewear, especially when riding in sunny conditions or off-road.

### CAUTION

**Wet pavement and/or wet tires and rims may cause slippery conditions and a dangerous situation. Extra breaking distance and slower speeds are required for your safety. Ride in wet weather only if necessary.**

## Riding in Wet Conditions

- Allow extra breaking distance.
- Ride more slowly.
- Apply both front and rear brakes intermittently to avoid skidding.

### CAUTION

**Night riding is not recommended. During night riding it is harder to see and be seen.**

## **Riding at Night**

- Check to make sure your bike's front and rear lighting are working properly.
- Check to make sure your bike's reflectors are in place.
- Wear reflective clothing and make sure accessories have reflectors.
- Wear an approved helmet with reflective tape on front and back.
- Never let children ride at night.
- Watch for pedestrians.

## **SPECIAL PRECAUTIONS**

### **Riding on the Road**

- Yield to pedestrians.
- Stop for Stop signs and traffic lights.
- Signal turns with hand signals.
- Be aware of hazardous surfaces like potholes, cracks, and uneven surfaces.
- Travel with traffic. Never ride against traffic.
- Know and follow the rules of the road.
- Be extra cautious at intersections, look well ahead and scan intersections before crossing.
- When you get off and walk your bike, you are considered a pedestrian, not a vehicle.
- Never ride bike across railroad tracks-always walk across.
- Watch for loose gravel when going around corners or curves.
- Be aware of parked cars, people could be inside about to open door or pull out onto road.
- Use bike lanes when available.
- Never ride with headphones.

- Do not do stunts, jumps or wheelies.
- Never ride under the influence of drugs or alcohol.

### **Riding on Sidewalks and Bike Paths**

- Know and follow the rules. Biking on sidewalks may not be allowed in your community.
- When biking from private property, driveways, or alley yield to all road users.
- Be aware of hazards such as: pets, children, strollers, sprinkler systems, debris, open gates, planters, other cyclists, skateboarders, walkers, and runners.
- Let others know you are coming by with voice or bell.

### **Crosswalks and Overpasses**

- Walk your bike to ensure right-of-way as a pedestrian or follow rules of the law for vehicles.

### **Hand signals**



*Left Turn*



*Right Turn*



*Alternate Right Turn*



*Stopping*

 **WARNING**

**Front braking, especially when biking downhill, can cause pitchover, serious personal injury or death.**

### **Riding Off-Road**

- Be safe and smart. Always wear a helmet.
- Keep weight balanced and low on bike.
- Move back on seat, stay low and minimize front braking on steep downhill.
- Stay clear of deep water.
- Ride only on trails open to bike where biking is allowed.
- Ensure your bike is in safe operating condition, carry a patch kit, basic tools and first aid kit.
- Do not ride alone, make sure someone knows where you are going and expected return time.
- Yield right-of-way to pedestrians and animals.

 **WARNING**

**A crash can put extreme stress on your bike's components. Stressed components can fail suddenly and cause loss of control, severe injury, or death.**

## **Safety Check Before Each Ride**

It is important to always check the condition of your bike before every ride in addition to having it regularly maintained. If you are unsure of how to do this, consult with a certified, reputable bike shop for assistance. For more information, please see the Pre-Ride Safety Checklist on page 31.

### **NOTICE**

**Electric Bicycles can be dangerous to use. The user or consumer assumes all risk of personal injuries, damage, or failure of the bicycle or system, and all other losses or damages to themselves and others and to any property arising as a result of using the electric bicycle.**

### **WARNING**

**Never touch the brake rotor, especially when the wheel and/or bike is in motion. Fingers may be severely injured by sharp edges or holes in the rotor. Grease or oil from fingers may damage or reduce the performance of the brakes.**

## OVERVIEW

1. Handlebar
2. HMI Display
3. PAS Remote
4. Throttle
5. Shifter
6. Rear Brake Lever
7. Front Brake Lever
8. Fork
9. Headlight
10. Front Wheel
11. Frame
12. Battery
13. Pedal
14. Seat
15. Battery Dock
16. Rear Rack
17. Rear Wheel
18. Kickstand
19. Rear Reflector

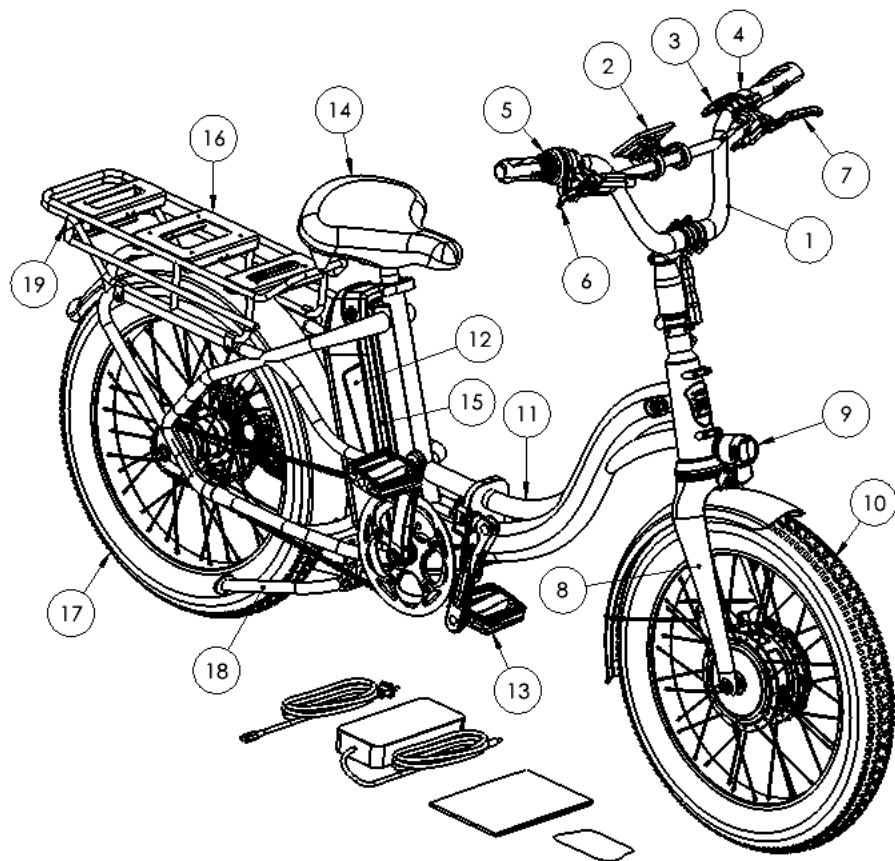

## IN THE BOX

1. Main Bike Assembly
2. Battery
3. Charger
4. Charger Cable
5. Owner Manual
6. Keys

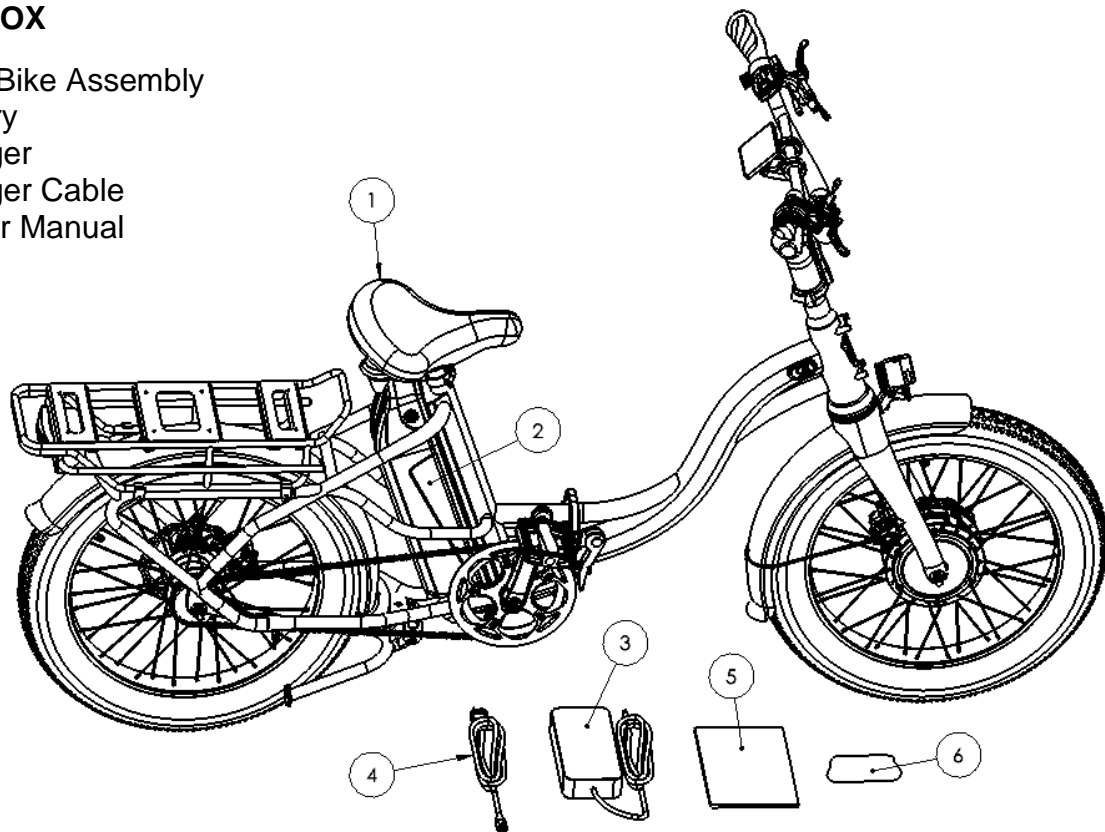



## SPECIFICATIONS

Frame Material	Aluminum alloy
Motor	Brushless Front Hub 500W
Riding Modes	5 Level Electric Assist
Pedal Sensor	Torque & Cadence
Max Speed	20 MPH by pedal, Class 2
Range	62+, depending on pedal effort
Throttle	Thumb Throttle, Left
Display	Color LED HMI
Battery	48V/15Ah, 720 Wh Lithium-ion Battery with LG cells
Charger	3A
Charging Time	Approx. 5-6 hours
Crankset	170mm/ 46T
Rear Hub	Shimano Nexus 7-speed
Rear Sprocket	20T
Brakes	Mechanical Disc Brake
Tires	20" x 3.0" Reflective Wall Fat Tires
Front Light	35 LUX Headlight
Rear Light	LED Tail Light

Front Fork	Fixed Aluminum
Fenders	Front & Rear Polymer, Black
Rear Rack	Aluminum, Universal
Max. Load Capacity	310 lbs. (140KG)
Overall Length	1757mm / 62.2 in
Handlebar Width	655mm / 25.8 in
Handlebar Height	Varies, (44.4 in / 1127 mm) as Shipped
Saddle Height	Varies, (30.3 in / 770 mm) Minimum
Net Weight (Product)	25.8 kg/ 57.3 lbs.
Gross Weight (Shipping)	31.5 kg/ 69.3 lbs.
Box Dimensions	38 in x 30.3 in x 18.3 in (96.5 cm x 77 cm x 46.5 cm)

## NOTICE

**The following steps are a general guide to assist you in assembling your bike. It is not meant to be a complete or comprehensive manual. It is recommended to consult a certified, reputable bike mechanic to assist with assembly, repair, and maintenance of your bike.**

### ASSEMBLY INSTRUCTIONS

Detailed assembly instructions are shown in the Young Electric Assembly Guide Video in the Resources tab under User Guide at <https://youngelectricbikes.com/>.

#### Step 1: Unpack Bike

Open the bike shipping carton from the top or side. Remove the small box inside shipping carton that contains the charger, keys, and owner's manual.

The bike will be shipped in folded condition. Carefully remove the folded bike from the shipping carton and gently rest it on the floor. It may be necessary to lean the bike against the wall or other vertical surface to keep it upright. Remove the zip tie used to hold the bike in folded position. Remove all packaging used to protect the bike during shipping.

## Step 2: Unfold Bike

Lift the front wheel slightly off the ground while keeping the bike upright. Rotate the front section of the frame with fork and front wheel until the frame hinge is closed. Make sure no cables or parts of the frame latch are in hinge as it is closed.

The frame uses an over center clamp with safety latch to hold bike frame closed. Rotate the latch handle into position to lock the frame closed. Press the handle into position until it is parallel with the side of the frame. The safety latch should automatically engage when the latch is closed.

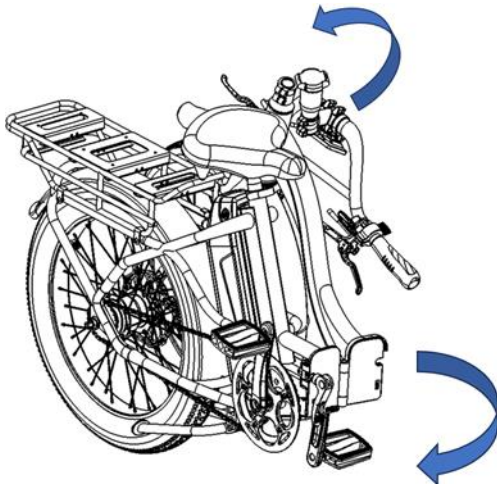

Put the kickstand down to support the bike. Use your foot to move the kickstand down to the ground. Pull the bike back slightly until the kickstand is fully extended under the bike frame. Lifting the back of bike from the rear rack will also allow the kickstand to go fully into position.

Rotate the handlebar assembly into position. The stem riser is the part of the assembly that contains the hinge and latch for folding handlebar assembly. Carefully, rotate the handlebar up until the hinge in stem riser is closed. Make sure no cables or wires are caught in hinge, caught on frame, or over-extended while rotating handlebar assembly.

The handlebar assembly also uses an over center clamp. Press the latch handle into position so the handle is parallel to the stem riser. The safety latch for stem riser should automatically engage when the latch handle is in fully closed position. Pull out slightly on the handle to confirm safety latch is engaged.

### Step 3: Install Battery

The battery should already be installed when you receive the bike.

#### To remove/install the battery:

- a. Insert key and turn counterclockwise to unlock battery.
- b. Make sure seat post is extended at least 3 inches (75mm) to allow space for the battery to be lifted under seat.
- c. Grasp the battery on both sides and pull it up.
- d. The battery will slide up and slightly away from the seat post as it comes out of battery dock.
- e. Carefully remove battery from inside frame.

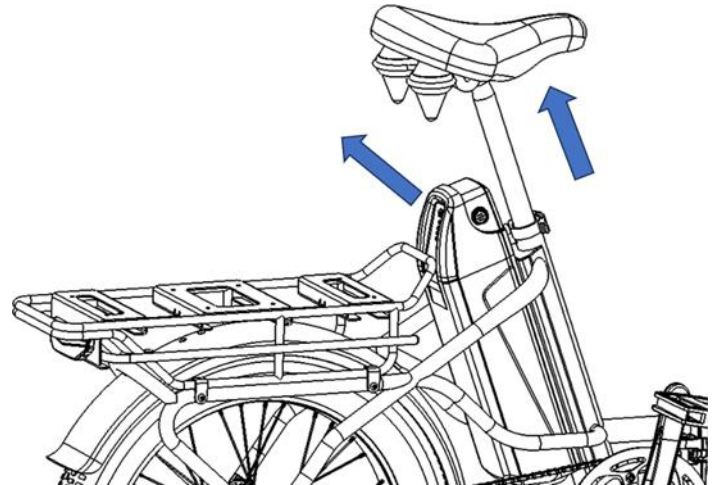

#### **Step 4: Confirm Bike Assembly**

The bike should be fully assembled when it has been unfolded. Make sure all components are tightly secured to the frame, fork, and handlebar. Make sure the battery is locked into the battery dock and keys have been placed in a secure location. Never leave the keys in battery as they may fall out and be lost.

#### **Step 5. Extend Seat**

- a. Open seat quick release to allow seat and post to slide and turn freely.
- b. Lift seat so it will be higher than a line extending from end of rear rack to top of handlebar.
- c. Close seat quick release.

### **WARNING**

**Always ensure all latches, levers, and quick releases are properly secured and undamaged. Make sure they are correctly secured before every ride. Bike parts may come loose and can result in loss of control, damage to bike or property, severe injury, and/or death.**



## Step 6: Check Handlebar, Stem, and Front Wheel Alignment

- Stand over the bike frame to check the alignment when the bike is in vertical riding position.
- Check to make sure the centerline of the stem is in line with the front wheel.
- Loosen the stem mounting bolt extending into the head tube to make an adjustment as needed. Use the 6mm Allen wrench to loosen and tighten as needed.
- Check to make sure the handlebar is centered in the stem and at comfortable position.
- Loosen handlebar clamp as needed to adjust handlebar per Step 2 instruction.

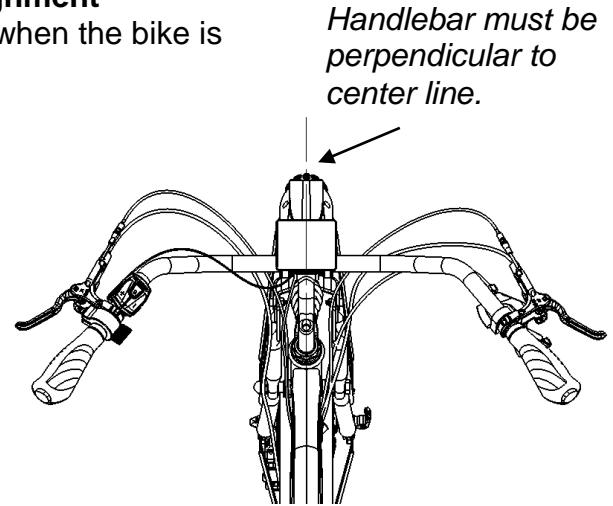

### **WARNING**

**Make sure all fasteners used to secure the handlebar and stem are tight. A loose handlebar could cause the rider to lose control and result in severe injury. Do not extend any component beyond the minimum insertion mark. Doing so could result in damage to bike, property, severe injury, or death.**



## Step 7. Review Pre-Ride Checklist

Safety Check	Basic Steps
Wheels and Tires	<ul style="list-style-type: none"> <li>-Ensure tires are inflated to recommended limits specified on tire side wall.</li> <li>-Ensure tire tread is good, have no bulges or cuts, and have no embedded objects that may puncture it.</li> <li>-Ensure rims have no damage, run true, do not wobble, have no dents or kinks.</li> <li>-Ensure all spokes are tight and are not broken.</li> <li>-Ensure axle nuts or quick release levers are tight.</li> <li>-Ensure locking lever of all quick release assemblies are secure.</li> <li>-Ensure that reflectors are securely in position on both wheels.</li> </ul>
Brakes	<ul style="list-style-type: none"> <li>-Ensure front and rear brakes function properly.</li> <li>-Ensure brake levers move freely, are firm, and do not touch handlebar grips when pulled with maximum hand force.</li> <li>-Ensure motor cutoff and brake light functions properly.</li> <li>-Ensure brake pads are positioned correctly, move freely, and do not have excess wear.</li> <li>-Ensure brake rotors are not damaged, have objects tangled in them, or have excess wear.</li> <li>-Ensure brake cable are adjusted correctly, are lubricated, and have no obvious damage.</li> </ul>

	<ul style="list-style-type: none"> <li>-Ensure brake caliper fasteners are secure, they are not leaking fluid, and do not have damage.</li> </ul>
Steering	<ul style="list-style-type: none"> <li>-Ensure handlebars and stem are correctly adjusted, fasteners are tight, and turn freely.</li> <li>-Ensure handlebars and stem are set correctly in relation to front wheel.</li> <li>-Ensure both handlebar grips are secure and do not have excess wear.</li> </ul>
Chain	<ul style="list-style-type: none"> <li>-Ensure chain is clean, well lubricated, and runs smoothly.</li> <li>-Ensure chain does not make any unusual noises or squeaks</li> <li>-Ensure no foreign material is lodged in chain links or excessive corrosion.</li> </ul>
Bearings	<ul style="list-style-type: none"> <li>-Ensure the bearings in headset, lower bracket, pedals, and both wheels turn freely.</li> <li>-Inspect for excess movement, rough feeling, grinding, rattling, and noise.</li> </ul>
Cranks and Pedals	<ul style="list-style-type: none"> <li>-Ensure both pedals are securely tightened to crank arms.</li> <li>-Ensure pedals turn freely, not bent, or damaged in any way.</li> <li>-Ensure the crank arms are securely fastened to bottom bracket shaft and are not bent.</li> </ul>

Rear Derailleur, Shifter, and Cable	<ul style="list-style-type: none"> <li>-Ensure derailleur is adjusted and functions properly.</li> <li>-Ensure shifter is functioning properly when shifting up and down through gears.</li> <li>-Ensure chain is not making noise in all gears.</li> <li>-Ensure derailleur moves freely, does not have any object tangled in it, and shift cable tightly secured to it.</li> <li>-Ensure shift cable is not damaged in any way and is properly adjusted.</li> </ul>
Frame, Fork, and Seat	<ul style="list-style-type: none"> <li>-Ensure frame and front fork are not bent or damaged in any way.</li> <li>-Inspect frame and fork for any cracks in the paint at welded joint.</li> <li>-Ensure seat is properly adjusted and quick release is securely tightened.</li> <li>-Ensure both wheels are evenly spaced in front fork and rear frame.</li> </ul>
Motor and Rear Wheel Assembly	<ul style="list-style-type: none"> <li>-Ensure hub motor spins smoothly in both directions.</li> <li>-Ensure motor power cable is not damaged and secured well to frame.</li> <li>-Ensure hub motor bolts are tight and there is no sign of damage to rear dropouts.</li> <li>-Ensure spokes are tight and there is no sign of damage.</li> </ul>
Battery	<ul style="list-style-type: none"> <li>-Ensure battery is fully charged before using the bike.</li> <li>-Ensure there is no damage to battery, and electrical connectors and mounting features are in good condition.</li> <li>-Ensure Secondary Battery (if equipped) is turned on.</li> </ul>

	<ul style="list-style-type: none"> <li>-Insert battery into lower mount and rotate it into upper mount. Ensure lock holds battery firmly in position.</li> <li>-Pull lightly on battery to ensure it will not come out after locking to frame.</li> <li>-Turn on HMI display to confirm battery is engaged and fully charged.</li> </ul>
Electrical Cables and Lights	<ul style="list-style-type: none"> <li>-Inspect all visible electrical connectors to confirm they are connected completely.</li> <li>-Ensure electrical cable grommets are in proper position to prevent damage to electrical and mechanical cables.</li> <li>-Ensure insulation on cables is not damaged and there are no exposed wires.</li> <li>-Carefully inspect cables that pass under bottom bracket to make sure cables are not damaged under bike.</li> <li>-Turn on bike to ensure headlight, taillight and brake lights are functioning properly.</li> </ul>
Accessories, Other, and PPE	<ul style="list-style-type: none"> <li>-Ensure all reflectors on bike are properly secured and visible.</li> <li>-Ensure rear rack and any other items are securely fastened to the frame.</li> <li>-Ensure fenders and mounting hardware are secure.</li> <li>-Ensure kickstand is functioning properly and fasteners are tight.</li> <li>-Inspect helmet and any other PPE to ensure they are not damaged and function properly.</li> <li>-Ensure rider is wearing a helmet, other required PPE, and is familiar with riding laws.</li> </ul>

## NOTICE

After your initial break-in period of 50-100mi (80-160km), it is important to have a certified, reputable bike mechanic perform a tune-up on your bike, as cables, spokes and chain will stretch, and bolt connections can loosen. Regular maintenance is important for safety and pleasurable riding.

## CAUTION

Do not use throttle while dismounted. Before mounting, operating, pedaling, dismounting, and/or removing an unlocked battery from the frame of your bike, make sure you remove the key from the battery. Failure to do so may cause damage to the key or battery, and/or cause injury.

Never use front brake by itself. Using both brakes, applying the rear brake first and then applying the front brake will cause less stress on components avoiding damage to bike and parts, and/or loss of control. Rear brake should be applied anytime front brake is engaged.

## WARNING

Never ride your bike while under the influence of any substance such as drugs or alcohol or any condition that could alter your ability to operate your bike safely.

## Proper Frame Size

For safe and comfortable riding there should be a clearance of at least 1-3 inches between the crotch of the intended rider and the top tube of the bicycle frame, while the rider straddles the bicycle with both feet flat on the ground. If there is less than 1-3 inches clearance, the bicycle is too large for the rider and should not be used.



### NOTICE

Rider leg should be only slightly bent when pedal is closest to ground, the ball of the foot is on the pedal, and rider is sitting on the seat.

## START-UP PROCEDURE

Once you have properly assembled your bike following the assembly video, ensuring all components are correctly secured, and have read and understand this entire manual, you may start your bike.

- a. Ensure battery key is in locked position. Remove key and carefully lift up on battery to make sure it is secure.
- b. Confirm correct handlebar and seat position. See Bike Adjustments section of this manual. Ensure faceplate bolts and seat post quick release are completely secured.
- c. Turn on your bike. Long press Power-On button until boot logo interface appears and then release button. You will be on the Home Screen.
- d. Check lights. Short press “Light” button to manually turn on or off bike light if needed.
- e. See Basic Function Operation section on page 40 to select PAS level, starting with level 0 or 1.
- f. Begin ride: In safe location and with proper safety gear, begin pedaling.
- g. Throttle: Always start with lowest PAS level and increase only when feeling comfortable. Short press “+” or “-“ buttons to switch assist level and change assist mode up or down. See pg. 40.

### CAUTION

**Consult your physician before riding any bike if you have an impairment or disability that could impact your ability to safely operate a vehicle.**

**As a parent or guardian, the activities and safety of your child is your responsibility, not that of Young Electric. Young Electric bikes are not designed or recommended for children under the age of 18.**

## BATTERY AND CHARGING INFORMATION

- Charge battery at ambient temperature close to 20°C (68°F).
- Avoid frequent full discharge. Battery life is improved with only partial discharge. Lithium-ion battery cells do have memory that can reduce battery capacity. Cell oxidation is caused by usage and aging; battery capacity will be reduced as battery becomes older.
- Deep discharge will cause irreversible damage and capacity loss for battery.
- Never charge battery for more than 12 hours at a time.
- Do not leave a charging battery unattended.
- The battery should be charged after each use.
- Remove charger from battery within one hour of complete charge.
- The provided charger is suitable for voltage range of 100-240V. Switching voltage range of charger is not required as it will automatically detect supply voltage. There is no switch on charger. Unplug battery and charger when not in use.
- To check present battery capacity, turn on system; information will be shown on the display.
- Do not push pedals when battery is charging on bike to avoid damaging the charge socket.

### **WARNING**

**Do not open battery housing, which will void warranty and can result in damage to battery or property or cause severe injury and/or death.**  
**The battery and charger shall not be repaired. Do not try to disassemble or modify battery or charger.**



## WARNING

**Charge battery only with charger originally supplied with your bike or a replacement Young Electric charger. Never use an aftermarket charger which can cause battery to overheat and explode, resulting in battery damage, property damage, severe injury, and/or death.**

### Battery Charging

The battery may be charged while on or off bike in a dry location but must not be moved during charging cycle. Lay battery and charger on a flat surface, with ports and plugs laying horizontal.

- a. Open charger cover on bike.
- b. Insert charger connector into charging port on battery.
- c. Insert cord into battery charger.
- d. Insert AC plug into an AC outlet.
- e. Disconnect battery when completely charged.

*Red Light: Battery is charging.  
Green Light: Battery is fully charged.*

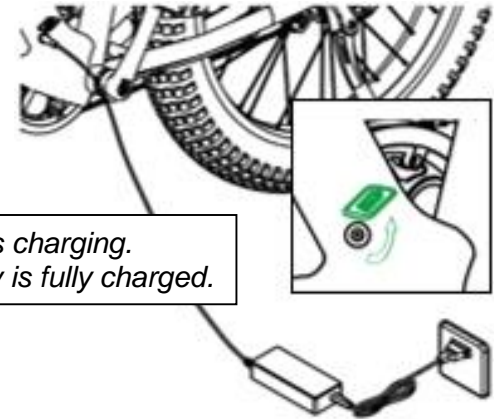

## CAUTION

**If the battery is physically damaged, non-functional, performing abnormally, or was dropped or involved in a crash, with or without obvious signs of damage, please discontinue use and charging and contact Young Electric immediately.**

## ⚠ CAUTION

**Avoid deep discharge during use and storage of battery. Deep discharge of battery may cause internal short circuit. Do not carry a deep-discharged battery on bike.**

**Heating battery to extremely high temperature may cause fire.**

**When not in use, battery should be fully charged once every 3 months. Always charge battery in temperature between 10°C (50°F) and 25°C (77°F) and ensure battery and charger are not damaged. Contact Young Electric if anything unusual is noticed.**

**Discontinue use if there is damage to battery connector terminals or battery mount.**

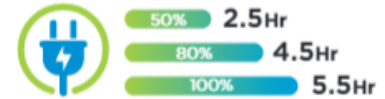
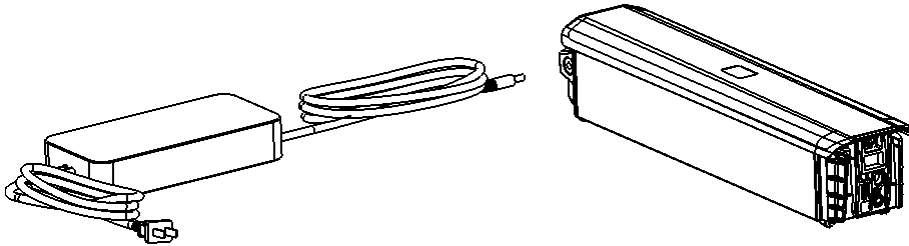

## NOTICE

**Do not cover the charger when plugged in or charging. The charger needs to be on a hard, flat surface in an open space to cool air. Ensure the indicator lights are facing upward. Do not use the charger inverted, which can inhibit cooling and reduce charger lifespan.**

## WARNING

**DO NOT** put battery in water. If battery pack is partially or totally submerged in water, it will suffer damage that compromises its safety and stability. This damage can be even more severe if battery pack was submerged in salt water.

**UNDER NO CIRCUMSTANCES** should you attempt to charge battery pack that has been partially or totally submerged in water. Attempting to charge compromised battery can result in a very dangerous fire that generates significant heat, toxic gasses and is extremely difficult to control, which can lead to severe injury or death.

Check your bike as soon as possible after partial or complete submersion. Most likely its electrical system has been damaged and is unsafe to use. Carefully remove battery pack from bike and take to safe location **OUTDOORS**, away from flammable materials.

To properly dispose of battery, place in clear plastic bag and take to your municipal household hazardous waste drop-off center. To find closest facility in your area check with your local City Hall or Fire Department or go to <https://www.call2recycle.org/locator/>.

Failure to adhere to these safety warnings can lead to severe injury or death.

## NOTICE

Failure to follow proper battery storage procedures can result in a non-functional battery. Replacement will not be covered under warranty.

 **WARNING**

**A damaged, wet, or dirty power cable or socket may cause electric shock and fatal injury. Stop using the battery immediately if become hot to touch, dissipates a strong odor, or has a distorted housing.**

**Use a dry and undamaged power cable and charger only.**

**Replace a damaged power cable or charger immediately.**

**Only use charger supplied with the product. Using another charger which is not provided by the product may cause battery overheating and explosion.**

**Heating the battery to extremely hot temperature may cause fire.**

**Avoid deep discharge of battery during the use and storage of battery.**

**When not in use, the battery should be fully charged once every 3 months at least.**

**Do not expose battery to storage temperatures below -20°C (-4°F) or above 45°C (113°F).**

**Note: The temperature above 60°C (140°F) may cause the internal structure overheating, especially in the environment under direct sunlight.**

**Do not use the charger in a humid environment or in the environment with temperatures below -10°C (14°F) or above 40°C (104°F).**

**Do not put the battery in water.**

**Before connecting power cable, remove foreign matters at charger port (dust, ice, snow, etc.).**

 **WARNING**

**Protect the battery against high pressure.**

**Do not use a battery with a damaged case.**

**Keep the battery away from children.**

**When charging, please ensure no flammable material is near the battery since it will generate heat.**

**Put the charger and battery on a non-flammable surface for charging. To charge a battery installed on the Electric bicycle, please put the Electric bicycle in a non-inflammable environment.**

**Do not charge the battery on a carpeted floor.**

**Do not cover the battery and charger during charging.**

## Battery Storage

Store battery on a solid non-flammable surface when not in use. To avoid damage to charge port and plug connection to socket, lay battery and charger on a flat surface, with ports and plugs horizontal.

For Long-Term Storage:

- Store battery in an environment within temperatures of -20°C (-4°F) and 45°C (113°F).
- Recommended storage of steady temperature range between 10°C (50°F) and 25°C (77°F).
- Store battery in dry environment protecting it against moisture to avoid corrosion of electrical contacts.
- Do not store battery near flammable items.

If battery is not used for a long time, it must be fully charged at least once every 3 months.

The battery will switch to offline in the following cases:

- E-Bike has not been used in 2 months.
- The battery is completely depleted and/or not charged for 3 months. Completely charge battery before returning to normal use.

If storing your bike for longer than two weeks at a time:

- Charge battery to approximately 75%.
- Power off battery and removed from frame.
- Store battery between 10°C (50°F) and 25°C (77°F) in a dry, climate-controlled location.
- Check battery every month, if necessary, use Young Electric charger to charge battery to 75%.

## HMI DISPLAY & PAS REMOTE



### **WARNING**

**When riding the electric bicycle, using the assistance instrument may distract you, causing unexpected risks causing severe injury or death. Only access PAS under proper traffic conditions. Access the information when bike is parked. Please slow down and use caution on a slippery pavement.**

Button	Function
Power	Turn on/off display.
PAS +	Press to increase PAS Level from 0-5 as needed. Then press button to switch functions.
PAS -	Press to decrease PAS Level 5-0 as needed. Long press for @ Level 0 for walk mode. Long press the adjust buttons to perform specific function operation.
Mode	Long press “M” button within 10s to enter parameter setting interface.
Lights	Turn on/off light.

Operation Type	Description
Short Press	To activate function, press button and release quickly.
Long Press	To select function, press and hold approximately 2 seconds.

## NOTICE

**The bike will still consume a very small amount of electrical current from battery when turned off. It is important to recharge the battery at least every few months when not in use. When the E-Bike is parked for approx. 10 minutes, the E-Bike system switches off automatically.**



## Basic Function Operation

### To turn on/off the display

To turn on display, long press Power-On button until boot logo interface appears and shortly enters the basic interface. To turn it off, long press Power-On button until display is turned off. If the rider does not perform any operation on the display within set shutdown time, while speed is 0, and current is less than 1A, then the bike and display will be turned off automatically.

### Assist Level Switch

During normal working state, short press “+” or “-” buttons to switch assist level and change assist mode up or down. Digital power assist display modes level: 0-5 levels are shown below:

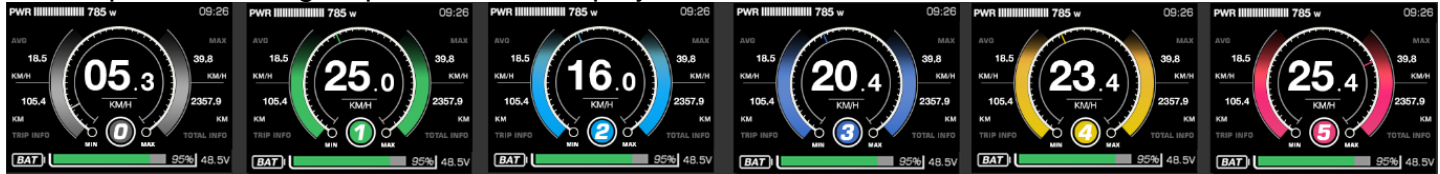

Short press “+” or “-” button to switch assist level. Switching level is not cycled, after reaching 5<sup>th</sup> level, short press “-” button to return to off level. It is the same when adjusting up.

### Information Switch

In a power-on state, short press “M” button to switch alternately from Basic Interface/Home Screen to Function/Information Screens. The switching process of each screen is shown in illustration.



*Boot Interface Screen*



*Basic Interface/Home Screen*

Press “M” button to go to next screen.

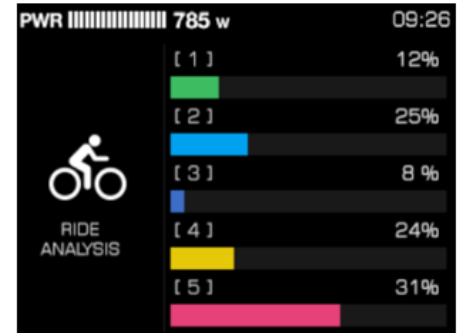
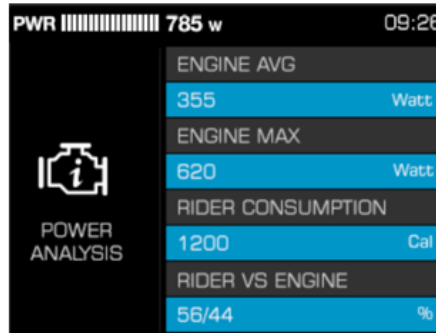
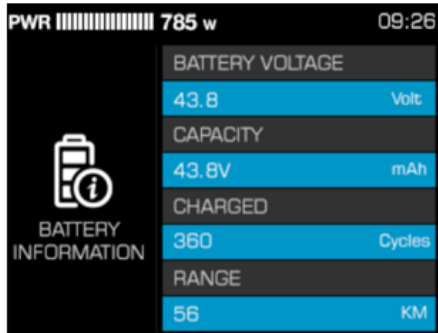

## Function/Information Screens

### Light Control Function

Short press “Light” button to manually turn on or off bike light. The icon  on the top right corner of the Basic Interface/Home Screen indicates the lights are on. When lights are on, short press “Light” button to turn off lights. When lights are on, screen brightness will be lowered to preset brightness level.

## Maintenance reminder

Display supports maintenance reminder function. When this function is enabled, the display will remind the user to contact bike shop for regular maintenance. The reminder is set to appear at a preset default value of ODO 3,106mi (5000km). End user is not allowed to change this default setting.



## Walk Assist Function

When speed is 0, Long Press “-” button to enter walk assist mode. The motor outputs power according to the set speed and controls the actual walk speed. The display shows the walk assist icon  and the real-time speed. Release “-” button or press any button to exit walk assist mode. The motor is turned off, and the display goes back to the Basic Interface/Home Screen. Walk Assist Interface shown right.









## Battery Power Indicator and Assist Power Output

Battery power information is divided into battery bar indication and remaining percentage indication. When battery power is normal, battery capacity is divided into 5 bars. Before communication is established, the battery percentage is not displayed, and the power bar is full and blinks at 2Hz. After battery info is acquired, power bar will stop blinking, and displays the power percentage. If communication is not successful within 3s, it will stop blinking and no power percentage will be displayed.

After battery capacity is lower than 5% or the voltage is lower than low voltage value, display will enter the low-voltage mode. In this mode battery level shows level 0 and border blinks at 1Hz, with no power output from the motor, and disabled assist level switch. Power assist level is displayed as OFF or 0. To get out of low-voltage mode, reset, and increase the voltage above low-voltage value and battery capacity above 5%.

## Percentage of Battery Power and Power Level Table

Battery % information is required from BMS or controller:

SOC	Battery level	Description
$80\% \leq \text{SOC}$	 The battery level indicator shows a full green bar with '100%' on the right and 'BAT' on the left.	Full battery level 5
$60\% \leq \text{SOC} < 80\%$	 The battery level indicator shows a green bar that is 80% full, with '80%' on the right and 'BAT' on the left.	Level 4
$40\% \leq \text{SOC} < 60\%$	 The battery level indicator shows a green bar that is 59% full, with '59%' on the right and 'BAT' on the left.	Level 3
$20\% \leq \text{SOC} < 40\%$	 The battery level indicator shows a green bar that is 39% full, with '39%' on the right and 'BAT' on the left.	Level 2
$10\% \leq \text{SOC} < 20\%$	 The battery level indicator shows a green bar that is 19% full, with '19%' on the right and 'BAT' on the left.	Level 1
$5\% \leq \text{SOC} < 10\%$	 The battery level indicator shows a green bar that is 9% full, with '9%' on the right and 'BAT' on the left.	Level 0
$0\% \leq \text{SOC} < 5\%$	 The battery level indicator shows a grey bar that is 0% full, with '0%' on the right and 'BAT' on the left.	Level 0 and icon blink at 1Hz

## Battery Indicator

When there is a battery communication error:

- Display will estimate the power according to the voltage and show the battery level accordingly.
- No battery percentage information will be shown.
- Range information will not be displayed.
- If the voltage is lower than the low-voltage value, the effect of the current on voltage needs to be considered when converting to a voltage at 0 current.

## Setting Function

Display provides specific parameter setting functions. The optional items of setting function will be deleted according to different market and product standards. The following is the complete parameter setting, information reading function description under the default state of display. Please contact our sales and technical support team for confirmation in case of any discrepancies.

- Within 10s after turning on display*, long press “M” button to enter setting interface, short press “+” or “-” button to switch between setting interfaces.
- Under any setting interface, short press “M” button to enter parameter editing state, the blue mark indicates chosen parameter, and selected option or value will be indicated by a white font with a grey background.
- Short press “+” or “-” button to edit parameters.
- Long press “M” button to confirm parameter selection. Long press “M” button again to exit and return to previous page.
- Selected option or value will be indicated by a white font with grey background. See Illustration.





Under any setting interface, short press “M” to enter the next level menu, and long press “M” button to return to the previous level menu.

Example of common interface setting screens:

### CAUTION

**Walk mode should only be used while dismounted from bike and with both hands on the handlebars. Always keep at least one hand on a brake lever to allow for quick cutoff of the motor assistance if necessary to maintain control of the bike.**

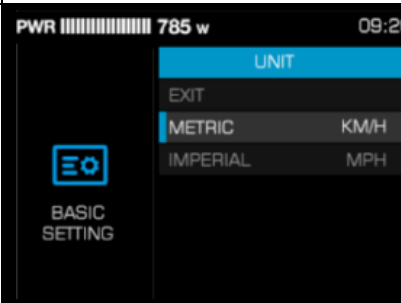

Setting items	Interface	Description	Setting data	Remark
Unit setting		UNIT	Value=KM/H MPH	Default Value=KM/H KM/H—Metric MPH—Imperial
Clock setting		SET TIME	Customization	Default= 12 : 00

When changing the time, press “+” or “-” to change the hour, then short press “M” button to confirm hour and move to minutes. Press “+” or “-” to change minutes, then short press “M” button to confirm minutes. Long press “M” button to return to previous menu.

## Data Clearance

Data clearance is aimed at the removal of data information such as subtotal mileage TRIP, average speed, and maximum speed. Ten seconds after display is turned on when display is at any of the function interfaces (not basic interface), long press “M” button to activate data clearance window, and short press “+” or “-” button to select accordingly. To remove the pop-up clearance window, long press “M” button or remain no operation for 30s.



After clearance, the subtotal mileage TRIP is 0, average speed, and max speed is 0. Riding analysis is also 0. ODO information cannot be cleaned manually on the display, professional service tools are required.

## Error Information

Display can warn bike faults. When faults are detected, error code will be shown on display in place of speed and blink at 1 per second. When error code is shown, button functions will not be affected, meaning interfaces can be shown normally by pressing buttons. If no button operation after 5s, display will return to error code interface. Error code interface shown right. See Error Code table 69.

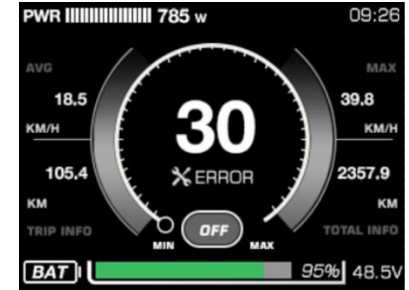

## Carrying Loads

The maximum weight limit for this bike is 310lb. (140 kg). This weight limit includes weight of rider and all items carried on bike. The rear rack weight limit is 59lb. (27 kg). Always make sure all items carried on bike are secured to prevent them from falling off during travel. Cargo should be carried as low as possible to lower center of gravity. Lower center of gravity improves handling and makes balancing bike easier. Cargo should never interfere with any moving bike components or drag on the ground. Carrying cargo load involves additional risks and requires particular care or attention.

### **WARNING**

**Never exceed rated weight limit of bike or rear rack. Exceeding rated limit can damage bike or rack; damaged bike may cause rider to lose control and result in severe injury.**  
**Never carry passengers on this bike. Passenger may fall from bike or become injured by moving parts.**  
**Never carry oversized objects on bike that may interfere with rider. Oversized objects may cause rider to lose control and result in severe injury.**

## ADJUSTMENTS

### **WARNING**

**Do not attempt to adjust or service your bike if you are not confident in your ability to do so. Adjustments and service performed improperly may result in damage to bike, void warranty, or accident resulting in serious personal injury or death.**

#### **Seat Position and Angle**

- Loosen the seat adjustment bolt on the clamp located under the seat, using an Allen wrench.
- Tilt the seat to adjust the angle. Do not exceed the limit markings on the seat rail.
- Using an Allen wrench, tighten the bolt securely while holding the seat in the desired position.

#### **Seat Height**

Sit on seat with ball of foot on pedal and pedal rotated to the lowest point. Position seat so that knee is slightly bent. Depending on user's preference, lowering the seat so the user can put one or both feet on the ground without dismounting from the seat may offer a safer and more comfortable experience. To adjust the height of the seat:

- Swing the quick release lever to the open position.
- Move seat up or down, set desired height.
- Tighten the adjustment nut on the seat post properly.
- Swing the quick release lever to the closed position.
- Check to make sure the seat is secure by twisting it back and forth. Tighten until secure.

## WARNING

- Never ride with seat post raised beyond “Maximum Height Mark,” which is stamped on side of seat post. Always keep a minimum of 2-1/2” of seat post in seat tube. Failure to do so may result in damage to bike and/or personal injury or death and may void warranty.
- Be sure to tighten seat clamp/seat adjustment bolt properly, before first use. Failure to do so may cause damage to the bike, property, loss of control, a fall, severe injury, or death. Regularly check seat clamp for proper tightness.

### Handlebar

The position of the handlebars is a personal choice.

To adjust handlebar position:

- Using Allen wrench to loosen the stem cap screws securing handlebar to stem. Do not remove screws.
- Have the rider sit on bike seat with hands on handlebar grips to move the handlebar to most comfortable position.
- Secure the stem cap screws with Allen wrench used to loosen. Make sure they are tight, not over tightened, and the handlebar is secure.

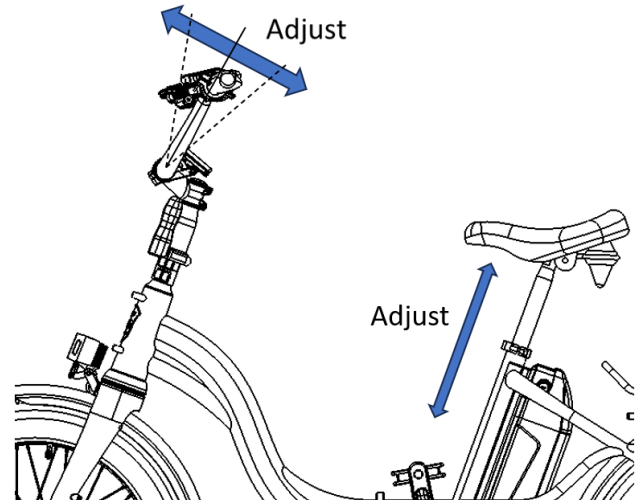

- Position of handlebar grips, brake levers, shifter, and other controls mounted on handlebar may need to be adjusted when position of handlebar is set.
- The stem may be changed to add additional position adjustment or to add more comfort with suspension type stem.

 **WARNING**

**Do not extend any components of bike beyond any minimum insertion marking etched into the components. Ensure that all hardware is properly tightened, and components are secured before moving onto the next step. Failure to do so could result in damage to bike, property, severe injury, or death.**

## Brakes

### **WARNING**

**Before use, ensure proper brake function. Brakes, brake pads and cables not properly adjusted and aligned may cause brake failure, loss of control, severe injury, or death. Do not brake suddenly or while turning, especially going downhill. Do not ride with improperly adjusted brakes or worn brake shoes. Always activate brakes properly, first the rear, then the front, always together. Ensure brake arm is securely fastened. Failure to abide by these warnings may result in serious personal injury or death.**

### **Brake Lever Reach**

If you find it difficult to squeeze the brake levers, your dealer can either adjust the reach or fit shorter reach brake levers.

### **CAUTION**

**The shorter the brake lever reach, the more critical it is to have correctly adjusted brakes, so that full braking power can be applied within available brake lever travel. Brake levers should NEVER touch handlebars when braking. The brake pads should be pressing hard to rims before levers are squeezed halfway to handlebars.**

## CAUTION

**Adjustment or modification of any brake component in a manner other than the manufacturer's recommended method will void warranty on that component.**

### **Brake Adjustment**

#### Realigning Calipers

- Position bike in well-lit area, on elevated bike stand or upside down.
- Loosen brake caliper bolts one full turn or until caliper is loose.
- Squeeze brake lever tightly to center caliper on rotor.
- Tighten bolts to hold the caliper in position when caliper is holding rotor.
- Release lever and check that space between rotor and brake pads is even.
- Spin wheel to test for rubbing.
- Tighten the mounting bolts firmly.
- Take bike for test ride.

#### Check for Rotor Rub

- Position bike on elevated stand.
- Spin wheels, check for gaps between rotor and brakes pads.
- Check for rubbing between rotor and pads and adjust calipers to realign rotor if necessary.
- Listen for clicking or scraping noise while tire spins and realign calipers to adjust brakes if necessary.
- Release lever and check that space between rotor and brake pads is even.



 **CAUTION**

**Ensure bolts are tightened securely and chain does not fall off.**

### **Shift Lever**

Take your bike to an Authorized Service Center if your shift lever needs to be adjusted or:

- Loosen the bolt keeping the shifter attached to the handlebar.
- Find your desired placement on the right-hand side of the handlebar as well as the angle. Young Electric recommends positioning the shifter in an area so that your fingers can easily access the levers and can smoothly shift between gears.
- Tighten the bolt.

 **CAUTION**

**Failure to adjust shift levers as specified by the manufacturer will void any warranty related to those components and can damage derailleurs and gear system.**

**When shifting, ensure pedals are in forward motion, never shift while pedaling backwards. Never force levers. Ease up on pedal pressure. Never shift more than one or two gears at a time. Never shift misadjusted derailleur on the largest or smallest sprocket.**

## MAINTENANCE, CLEANING & STORAGE

### WARNING

**Always properly maintain and care for your bicycle so original quality and safety are retained. To reduce the risk of accidents and injury, have your bike maintained, adjusted, and repaired by an Authorized Service Center or certified, reputable bike mechanic. For more information, please contact us at [cservice.fus@youngelectricbikes.com](mailto:cservice.fus@youngelectricbikes.com) or 888-332-8582 / 888-933-8899.**

### **Basic Bike Care**

To ensure safe riding conditions you must properly maintain your bike. It is recommended you consult a certified bike mechanic regularly to ensure your bike is safe for use and fun to ride.

- Properly maintain batteries by keeping them fully charged between uses of more than two weeks apart. See the Long-Term Battery Storage section on pg. 37 for information.
- Never immerse or submerge bike or components in water or liquid which could damage electrical system.
- Periodically check wiring and connectors ensuring no damage and connectors are secure.
- Clean by wiping frame with damp cloth. Only use mild non-abrasive detergent with damp cloth, never solvent. Never dry wipe dried on dirt. Dry by wiping with a clean, dry cloth.
- Store under shelter; avoid leaving bike in rain or exposed to corrosive materials. If exposed to rain, dry bike afterward and apply anti-rust treatment to chain and other unpainted steel surfaces.
- Riding on beach or in coastal areas exposes your bike to salt, which is very corrosive. Wipe down your bike frequently and wipe or spray all unpainted parts with anti-rust treatment. Damage from

corrosion is not covered under warranty so special care should be given to extend life of bike when used in coastal areas or areas with salty air or water.

- If hub and bottom bracket bearings have been submerged in water or liquid, they take out and re-grease. This will prevent accelerated bearing deterioration.
- If paint has become scratched or chipped in metal, use touch up paint to prevent rust. Clear nail polish can also be used as a preventative measure.
- Do not store near electric motors, which can destroy rubber and paint.
- Regularly clean and lubricate all moving parts, tighten components, and adjust as required.
- Regularly inspect all pre-attached and optional component hardware to ensure tight and secure attachment, and good working condition.

### CAUTION

**If you do not have the experience, skill, and tools to complete maintenance and adjustment of your bike, Young Electric bikes strongly recommends having a certified, reputable bike mechanic maintain, tune, and ensure the bike is safe to ride.**

### **Tire Pressure & Inspection**

- See the side wall of bike tires for proper size for bike. These tires use a rubber inner tube to retain air pressure. The tires are designed for typical terrain and surfaces bike was intended to be used on. Only replace tires with a similar tire design of same size.
- Always check all items related to Tires and Wheels listed in Pre-Ride Check before each ride.

- Properly inflated tires will help to ensure best bike performance, longest range possible and maximum life of tires. Keep tires inflated to 15-30 P.S.I.at all times. Never exceed maximum pressure listed on tire side wall.
- Tires will lose air pressure over time. Always check tire pressure before operating the bike. Low tire pressure can result in damage to wheels that will be more difficult and expensive to repair.
- Always replace tires with equivalent tires with reflective side walls. Bike is equipped by the factory with this type of tire to provide most visibility in low light conditions. Keep tires clean to ensure reflective side wall can function properly.
  - Remove the valve cap and add air.
  - Be sure the tire is evenly seated on the rim, both sides.
  - Spin the wheel and check for high and low areas.
  - Complete inflation to the recommended psi found on the sidewall of the tire.
  - Ensure tire is evenly seated on rim, both sides. If not, release some air and repeat steps shown above.
  - Check for dirt in the valve cap or stem. Clean dirt from cap or stem before adding air.
  - Securely replace the valve cap on the stem to keep dirt out of valve.

 **WARNING**

**-Never inflate a tire beyond the maximum pressure marked on the tire's sidewall or the wheel rim. If the maximum pressure rating for the wheel rim is lower than the maximum pressure shown on the tire, always use the lower rating. Exceeding the recommended maximum pressure may blow the tire off the rim or damage the wheel rim, which could cause damage to the bike and injury to the rider and bystanders.**

**-An unseated tire can rupture unexpectedly and cause serious injury or death. Be sure the tire is properly seated when inflating the tube.**

**-Over inflation or inflating the tube too quickly may result in the tire blowing off the rim and damaging the bicycle or causing injury to the rider. Always use a hand pump to inflate the tube. Do not use a gas station service pump to inflate the tube.**

 **WARNING**

**Failure to conduct maintenance on the bicycle may result in malfunction of a critical part and serious injury or death. Proper maintenance is critical to the performance and safe operation of the bicycle.**

**The recommended intervals and need for lubrication and maintenance may vary depending on condition the bicycle is exposed to. Always inspect the bicycle and conduct necessary maintenance before each use of the bicycle.**

## Lubricate Chain Recommendation

Component	Lubricant	Method
<b>Weekly</b>		
Chains	Chain lube or light oil	Brush on or squirt
Brake calipers	Oil	Three drops from oil can
Brake levers	Oil	Two drops from oil can
Freewheel	Oil	Two drops from oil can
Derailleur Systems	Light oil or grease	All pivot points should be lubricated (more often in severely rainy or muddy conditions). Wipe off any excess oil.
Brake cables	Lithium based grease	Remove cable from casing. Grease entire length. Wipe off excess lubrication from other surfaces.
Brake lever and caliper pivot points	Light oil	Two to three drops from oil can
Shifting cables	Thin layer of grease	Clean and grease
<b>Yearly</b>		
Bottom bracket	Lithium based grease	Disassemble
Pedals	Lithium based grease	Disassemble
Wheel bearings	Lithium based grease	Disassemble
Headset	Lithium based grease	Disassemble
Seat stem	Lithium based grease	Disassemble
Pedals: that can be disassembled		See bicycle mechanic for maintenance.

**Note:** The frequency of maintenance should increase with use in wet or dusty conditions. Do not over lubricate. Remove excess lubricant to prevent dirt build up. **Never** use a degreaser to lubricate your chains (WD-40®).

## Recommended Service Intervals

Interval	Inspect	Service	Replace
<p><b>Weekly, 100-200 miles</b></p>	<ul style="list-style-type: none"> <li>-Check hardware.</li> <li>-Check drivetrain for proper alignment and function (including chain, freewheel, chainring, and derailleur).</li> <li>-Check wheel trueness and for quiet wheel operation (without spoke noise).</li> <li>-Check condition of frame for any damage.</li> <li>-Check and tighten pedals.</li> </ul>	<ul style="list-style-type: none"> <li>-Clean frame, chainrings, cassette, and derailleur pulleys with damp cloth.</li> <li>-Use barrel adjusters to tension derailleur/brake cables if needed.</li> </ul>	<ul style="list-style-type: none"> <li>-Replace any components confirmed by Young Electric Bikes Technical Support or a certified, reputable bike mechanic to be damaged beyond repair or broken.</li> </ul>

<b>Interval</b>	<b>Inspect</b>	<b>Service</b>	<b>Replace</b>
<p><b>Monthly, 250-750 miles</b></p>	<ul style="list-style-type: none"> <li>-Check brake pad condition and alignment.</li> <li>-Check crankset and pedal torque.</li> <li>-Check bike shifts properly, proper derailleur cable tension.</li> <li>-Check chain stretch.</li> <li>-Check brake and shifter cables for corrosion or fraying.</li> <li>-Check spoke tension.</li> <li>-Check accessory mounting (rack mounting bolts, fender hardware, and alignment).</li> </ul>	<ul style="list-style-type: none"> <li>-Clean and lubricate drivetrain.</li> <li>-Clean brake and lube shift cables.</li> <li>-True and tension wheels if any loose spokes are discovered.</li> <li>-Wipe down and lubricate suspension fork (if applicable).</li> </ul>	<ul style="list-style-type: none"> <li>-Replace brake and shift cables if necessary.</li> <li>-Replace brake pads if necessary.</li> </ul>



<b>Interval</b>	<b>Inspect</b>	<b>Service</b>	<b>Replace</b>
<p><b>Every 6 months, 750-1250 miles</b></p>	<ul style="list-style-type: none"> <li>-Inspect all cables and housings.</li> <li>-Safety check all bolts.</li> <li>-Check bearing system.</li> <li>-Ensure drivetrain is working as normal.</li> </ul>	<ul style="list-style-type: none"> <li>-Standard tune-up by certified, reputable bike mechanic is recommended.</li> <li>-Grease bottom bracket.</li> <li>-Adjust gear shifters to ensure power functionality.</li> <li>-Adjust brakes to ensure proper functionality.</li> <li>-Lube both brake and gear shifting systems</li> <li>-True wheels if they wobble.</li> </ul>	<ul style="list-style-type: none"> <li>-Replace brake pads.</li> <li>-Replace tires if necessary.</li> <li>-Replace cables and housings if necessary.</li> </ul>

**TROUBLESHOOTING:** [cservice.fus@youngelectricbikes.com](mailto:cservice.fus@youngelectricbikes.com), <https://youngelectricbikes.com/>

<b>Symptoms</b>	<b>Possible Cause</b>	<b>Most Common Solution</b>
Bike Does Not Work	<ol style="list-style-type: none"> <li>1. Depleted/very low battery charge.</li> <li>2. Faulty connections</li> <li>3. Battery not fully seated in connector.</li> <li>4. Improperly turned on</li> <li>5. Blown Discharge Fuse in battery.</li> <li>6. Brakes applied or stuck</li> </ol>	<ol style="list-style-type: none"> <li>1. Charge Battery</li> <li>2. Clean or repair connector</li> <li>3. Reinstall battery and ensure completely seated.</li> <li>4. Review manual, follow start procedure.</li> <li>5. Replace it with new fuse, same size.</li> <li>6. Disengage/free brakes</li> </ol>
Reduced Range	<ol style="list-style-type: none"> <li>1. Low tire pressure</li> <li>2. Low or faulty battery</li> <li>3. Riding with too many hills, excessive load, headwind, applying brake while riding.</li> <li>4. Battery was left discharged for long period of time without regular charging, aged, damaged, or unbalanced cells.</li> <li>5. Brakes adjusted improperly</li> </ol>	<ol style="list-style-type: none"> <li>1. Adjust tire pressure.</li> <li>2. Check connections and/or fully charge battery.</li> <li>3. Assist bike with greater pedal effort, change route, reduce load on bike.</li> <li>4. Balance the battery. Contact Customer Service or Authorized Service shop if reduced range persists.</li> <li>5. Adjust the brakes to eliminate drag when brake levers are not pulled, ensure calipers and/or pads can move freely.</li> </ol>

Irregular Acceleration and/or Reduced Top Speed	<ol style="list-style-type: none"> <li>1. Insufficient battery power</li> <li>2. Loose or damaged throttle/PAS controller</li> <li>3. Damaged torque sensor in bottom bracket</li> </ol>	<ol style="list-style-type: none"> <li>1. Charge or replace battery.</li> <li>2. Replace throttle/PAS controller.</li> <li>3. Contact Authorized Service shop for repair</li> </ol>
Motor Does Not Respond When Bike is Powered On	<ol style="list-style-type: none"> <li>1. Loose/damaged wiring connection</li> <li>2. Loose/damaged throttle/PAS controller</li> <li>3. Loose/damaged motor wires/plug</li> <li>4. Damaged motor</li> </ol>	<ol style="list-style-type: none"> <li>1. Repair and/or reconnect.</li> <li>2. Tighten or replace.</li> <li>3. Secure, repair, or replace damaged wires.</li> <li>4. Contact Authorized Service shop to replace.</li> </ol>
Battery Will Not Charge	<ol style="list-style-type: none"> <li>1. Charger not connected well/completely.</li> <li>2. Charger damaged</li> <li>3. Battery damaged</li> <li>4. Wiring damaged</li> <li>5. Blown battery fuse</li> </ol>	<ol style="list-style-type: none"> <li>1. Adjust the connections.</li> <li>2. Replace</li> <li>3. Replace</li> <li>4. Repair or replace.</li> <li>5. Reset circuit breaker or replace fuse</li> </ol>
Wheel or Motor Make Strange Noises	<ol style="list-style-type: none"> <li>1. Loose/damaged wheel spokes or rim</li> <li>2. Loose/damaged motor wiring</li> <li>3. Debris interfering with wheels</li> </ol>	<ol style="list-style-type: none"> <li>1. Tighten, repair, or replace.</li> <li>2. Reconnect or replace motor.</li> <li>3. Remove debris and inspect for damage</li> </ol>
Brake Failure	<ol style="list-style-type: none"> <li>1. Air in brake line</li> </ol>	<ol style="list-style-type: none"> <li>1. Get brake bleed kit</li> </ol>

**Error Code Table:** Error code will be shown in center of display where speed is displayed.

Error code	Error description
"00"	Normal
"10"	Over Voltage
"11"	Under Voltage
"12"	Speed Feedback Fault
"13"	Over Temperature
"14"	Voltage Fault
"15"	Abnormal Output
"16"	MCU Fault
"17"	Runaway Protection
"18"	Pedal Sensor Fault
"19"	Speed Sensor Fault
"20"	COM Fault
"21"	Over Current
"22"	Throttle Fault

"23"	Phase Fault
"24"	Hall Fault
"25"	Brake Fault
"30"	Communication failure

## SERVICE PARTS

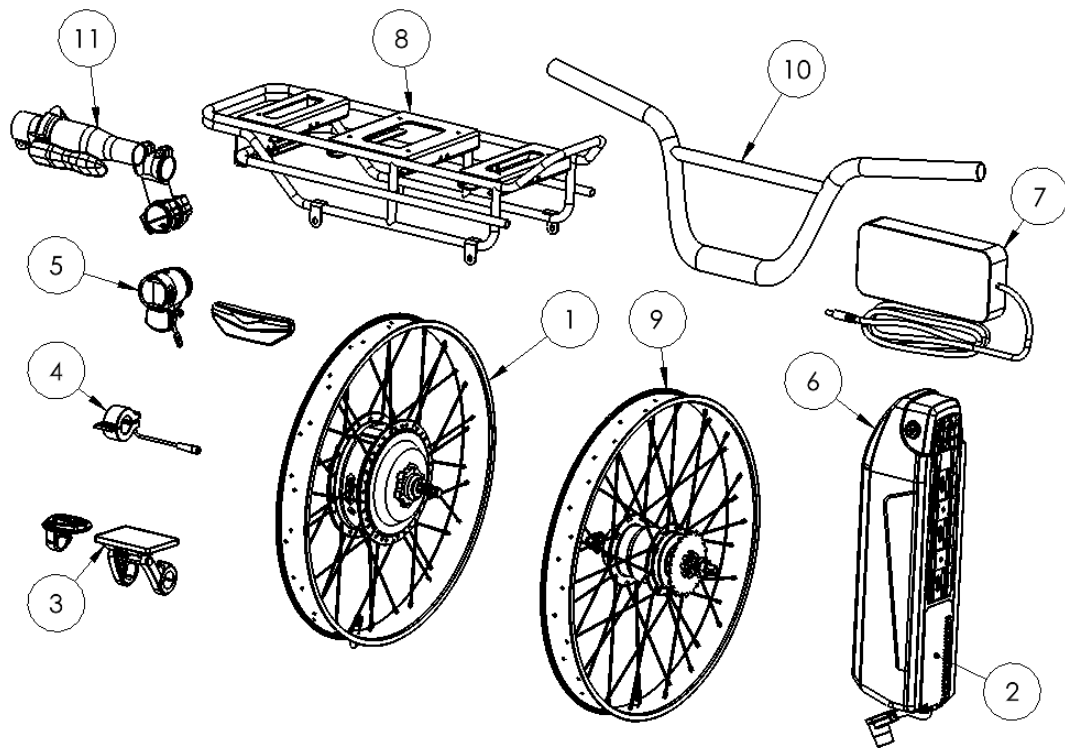

Item #	Service Kit Description	Part Number
1	KIT SVC ASSY WHEEL FRONT w/MOTOR	FUS-12802300-0001
2	KIT SVC DOCK BATTERY w/ CONTROLLER	FUS-12802300-0002
3	KIT SVC HMI DISPLAY w/ PAS REMOTE	FUS-12802200-0003
4	KIT SVC THROTTLE	FUS-12802200-0004
5	KIT SVC ASSY HEADLIGHT + TAILLIGHT	FUS-12802300-0003
6	KIT SVC BATTERY E-URBAN15Ah	FUS-12802300-0004
7	KIT SVC CHARGER 48V, 3A FAST CHARGE	FUS-12802200-0007
8	KIT SVC ASSY RACK REAR URBAN	FUS-12802300-0005
9	KIT SVC ASSY IGH WHEEL REAR 7Spd URBAN	FUS-12802300-0007
10	KIT SVC HANDLEBAR URBAN	FUS-12802300-0008
11	KIT SVC STEM w/STEM RISER URBAN	FUS-12802300-0009

**LIMITED WARRANTY**-Fill in the below information and keep in a safe place.

**WARRANTY REGISTRATION CARD**

Owner Name:

Address:

City, State, Zip, Country:

Phone:

Model:

Color:

Size:

Electric bicycle Serial Number:

Battery Serial Number:

Model:

Color:

Dealer Name

Address:

City, State, Zip, Country:

Date of Purchase:



## **Length of Warranty**

Every bicycle has a useful product lifespan. This limited warranty is not meant to suggest or imply that the frame or components can never be broken or will last forever. This limited warranty covers manufacturing defects that occur within the normal lifespan and use of the product.

For Young Electric bike, the serial number is the certificate for after-sales (warranty). Before purchasing, please check the serial number in detail. In case of a worn serial number, please do not purchase the E-Bike. Please register your E-Bike information at [youngelectricbikes.com](http://youngelectricbikes.com).

## **You must register your YOUNG E-Bike within 30 days of purchase for warranty to be valid.**

- .The Electric bicycle Serial Number is noted on the Master Carton.
- .The Electric bicycle Serial Number is noted on the bottom tube of frame.
- .The Battery Serial Number is noted on the battery pack.

## **Warranty Conditions**

This limited warranty applies only to the original owner of the bicycle and is not transferable to subsequent owners or other transferee of the electric bicycle. Only the original owner of an electric bicycle purchased from YOUNG ELECTRIC online or YOUNG ELECTRIC authorized distributor or retailer is covered by Limited Warranty. The Warranty Period begins upon your receipt of the electric bicycle and shall end immediately when any sale or transfer of the electric bicycle is made, and under no circumstances shall the Limited Warranty apply to any subsequent owner or other transfer of the electric bicycle.

Bike Frame: 5-year warranty

All other mechanical components: 1-year warranty

Electrical components: 2-year warranty

For any warranty claim to be considered, the E-Bike must be in an assembled, clean, and sanitary condition and accompanied by the original, dated sales receipt for the bicycle. Be sure to keep your receipt in a safe place!

This limited warranty is void if the bicycle is subjected to abuse, neglect, improper repair, improper assembly, lack of proper maintenance according to the owner's manual, alteration, modification, installation of incompatible parts, corrosion, an accident or other abnormal, excessive, or improper use. This limited warranty is void if the bicycle is used in a rental or bike sharing program.

Damage resulting from normal wear and tear, including the results of fatigue, is not covered. It is the owner's responsibility to regularly inspect and properly maintain his/her bicycle.

Some items that typically exhibit damage from normal wear and tear include:

Bearings, Bearing races, Brake disks, Brake pads, Bushings, Cables and housing, Cassettes, Chain, Chain rings, Handlebar and grips, Rear shock mounting hardware, Saddles, Seals, Spokes, Tires, Tubes, Wheel hubs.

Damage to a Covered Component during shipping is not covered by this Limited Warranty, but YOUNG ELECTRIC will replace such damaged Covered Components if you:

- Notify YOUNG ELECTRIC of a Covered Component damaged in the shipping process *within thirty (30) days* of your receipt of the electric bicycle.
- Provide YOUNG ELECTRIC with a dated picture of the damaged Covered Component.
- Return all original packaging and paperwork included with the electric bicycle.
- Note any immediately recognizable damage on the shipper's Bill of Lading prior to signing off on the shipment.
- Shipping damage claims are very time sensitive, and it is your responsibility to immediately inspect the electric bicycle for damage upon receipt.

Paint fading caused by the effects of ultraviolet light (UV), or outdoor exposure is not covered by this limited warranty. All labor charges for warranty service, including the transfer of components and/or any installation of new components, are the responsibility of the bicycle owner.

Due to product evolution and obsolescence (such as products that have been discontinued or are no longer kept in stock), some frames or components may not be available for older or limited-edition models. In these cases, Young Electric may elect to provide a replacement that it determines to be the most comparable model, but sourcing and paying for components is the responsibility of the bicycle owner.

All determinations under this limited warranty will be made in the sole discretion of YOUNG ELECTRIC, including but not limited to the decision to repair or replace a defective product, and what replacement product is the most comparable product then available.

THE REMEDIES STATED ABOVE ARE THE EXCLUSIVE REMEDIES UNDER THIS WARRANTY. ANY AND ALL OTHER REMEDIES AND DAMAGES THAT MAY OTHERWISE BE APPLICABLE ARE EXCLUDED, INCLUDING, BUT NOT LIMITED TO, INCIDENTAL OR CONSEQUENTIAL DAMAGES, DAMAGES TO OTHER PROPERTY, OR ANY PUNITIVE DAMAGES.

THIS IS THE ONLY WARRANTY MADE BY YOUNG ON ITS FRAMES AND COMPONENTS, AND THERE ARE NO WARRANTIES WHICH EXTEND BEYOND THE DESCRIPTION HEREIN. ANY WARRANTIES THAT MAY OTHERWISE BE IMPLIED BY LAW INCLUDING, BUT NOT LIMITED TO, ANY IMPLIED WARRANTY OF MERCHANTABILITY OR FITNESS FOR A PARTICULAR PURPOSE, ARE EXCLUDED.

PLEASE REFER TO THE DOCUMENTS INCLUDED WITH YOUR BICYCLE FOR POSSIBLE FURTHER RESTRICTIONS.

THIS LIMITED WARRANTY GIVES THE CONSUMER SPECIFIC LEGAL RIGHTS. THE CONSUMER MAY ALSO HAVE OTHER LEGAL RIGHTS WHICH VARY FROM STATE TO STATE OR COUNTRY TO COUNTRY. SOME STATES AND COUNTRIES DO NOT ALLOW THE EXCLUSION OR LIMITATION OF INCIDENTAL OR CONSEQUENTIAL DAMAGES OR WARRANTIES, SO THE ABOVE LIMITATIONS OR EXCLUSIONS MAY NOT APPLY TO YOU. IF IT IS DETERMINED BY A COURT OF COMPETENT JURISDICTION THAT A CERTAIN PROVISION OF THIS LIMITED WARRANTY DOES NOT APPLY, SUCH DETERMINATION SHALL NOT AFFECT ANY OTHER PROVISION OF THIS LIMITED WARRANTY AND ALL OTHER PROVISIONS SHALL REMAIN IN EFFECT.



Distributed by Forcome Co., Ltd

[Email: cservice.fus@youngelectricbikes.com](mailto:cservice.fus@youngelectricbikes.com)

Toll- Free Number: (888) 332-8582/ (888)-933-8899

<https://youngelectricbikes.com/>

Version II