



youne
Electric



Scan for Product Assembly Video

Owner's Manual

E-SCOUT PRO

E-SCOUT PRO ST

Table of Contents

ABOUT THIS MANUAL.....2

YOUNG ELECTRIC BICYCLE OVERVIEW.....3

SPECIFICATIONS.....4

SAFETY PRECAUTIONS5

ASSEMBLY INSTRUCTIONS.....6-19

BATTERY CHARGING & STORAGE.....20-23

PRE-RIDING CHECK.....24-26

HMI CONTROL.....27-30

MAINTANCE..... 30-35

SERVICE PARTS.....36-37

LIMITED WARRANTY.....38-40

THANK YOU FOR CHOOSING A YOUNG ELECTRIC BICYCLE !

YOUNG ELECTRIC bikes are designed to make your riding experience a pleasure. Carefully read this Owner's Manual before assembly and first ride. It will give you all the information necessary for assembly, adjusting, and maintenance of your bike.

YOUNG ELECTRIC works hard to guarantee you a bicycle that is properly assembled and correctly adjusted when it leaves our factory. Please contact our Help Center if you still have questions about your new bike after reading this manual. Our customer service staff will work to answer questions regarding assembly, performance, operation, service parts or general service.

Email: support@youngelectricbikes.com/

About this Manual:

<p>YOUNG ELECTRIC is not liable for accidents or injuries due to improper use of the product, failure to adhere to the instructions given in this guide, or modifications to the product. While every effort has been made to ensure that the information contained in the guide is accurate and complete, YOUNG ELECTRIC is not liable for any errors or omissions.</p>
--

Keep this Owner's Manual in a safe place for future reference. All content in this manual is subject to change as we continually work to refine our products.

This manual contains warnings, cautions, and notes for your safety. Carefully read all of this information and share with others that may ride this bike before attempting to operate the bike for the first time. Give special attention to any information that has a warning or caution symbol before or next to it. Also pay attention to any information preceded by NOTICE as this will be important information that may not be related to safety.

Always properly maintain and care for your bicycle so original quality and safety are retained.

Maintenance, adjusting and repairs

To reduce the risk of accidents and injury, regularly inspect your bicycle and have it repaired at our authorized distributors or after sales service shop. Assembly and adjustment of this bike may require special tools and skills. It is recommended that assembly and adjustment of this bike be completed by a certified, reputable bike mechanic if possible.

All users must read and understand this manual before riding their bike from A YOUNG ELECTRIC Bike. Additional manuals for components used on the bike may also be provided and should be read before installing or using those components.

OVERVIEW

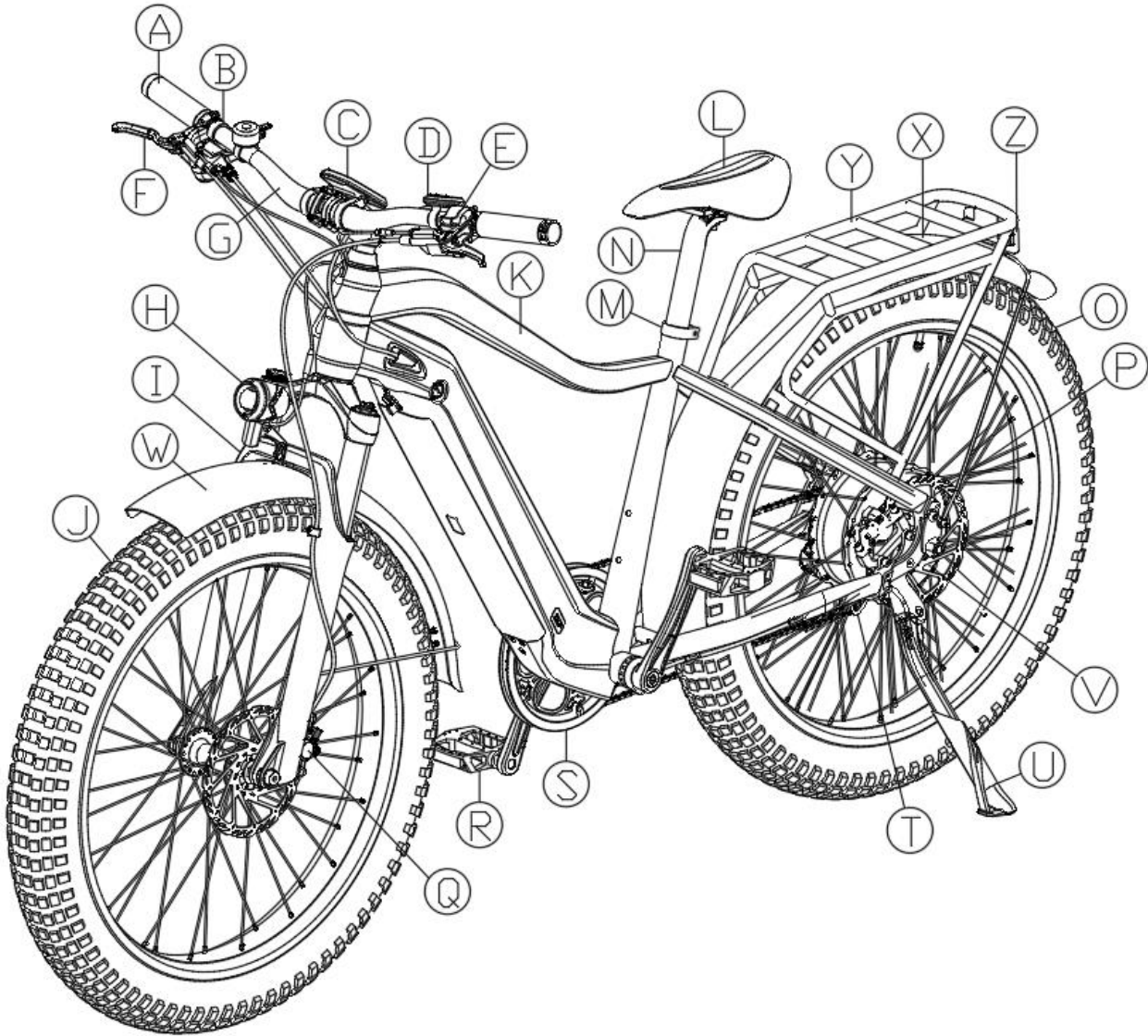

A	Grip	H	Headlight	O	Rear Wheel	V	Rear Hub Motor
B	Shift Lever	I	Suspension Fork	P	Rear Disc Brake	W	Front Fender
C	HMI Display	J	Front Wheel	Q	Front Disc Brake	X	Rear Fender
D	Remoter	K	Frame	R	Pedal	Y	Rear Rack
E	Throttle	L	Saddle	S	Crank Set	Z	Taillight
F	Brake Lever	M	Seat Post Clamp	T	Rear Derailleur		
G	Handlebar	N	Seat Post	U	Kickstand		

SPECIFICATIONS

Model Name	YOUNG ELECTRIC E-Scout Pro
Max. Load Capacity	330lbs. /149 kg
Max. Speed	USA: 20MPH & 28MPH ; Canada: 20MPH (32km/h); (Based on local legal requirements)
Motor	USA: 48V 750W Brushless Hub Motor; CANADA: 500W Rear Hub Motor; (For Road Legal Use Across Canada)
Battery	48V 20AH (960Wh) Li-ion
Light	Front/Rear
Wheel Size	26''X4.0'' Front/Rear
Tire Pressure	5-30 P.S.I. (0.4-2.1 BAR ; 40-210 KPA)
Charger	48V 3Ah
Charging Time	Approx.8-10 Hours
Water Resistance	IPX4 – It can survive minor water splashes but can't be submerged or soaked with a water hose .
Weight	82 lbs. /37kg

SAFETY PRECAUTIONS

The following safety signal words indicate the following information is a safety message. The symbols are to alert you to potential hazards. Failure to pay attention to the safety message may result in property damage, injury or death. This manual contains many WARNING and CAUTION messages related to safety and the potential hazard. It also contains NOTICE messages that information the user should pay special attention to.

 **WARNING**

Indicates a hazard or unsafe practice that can result in severe injury or death if the user fails to read, understand and follow the safety information in this manual.

 **CAUTION**

Indicates a hazard or unsafe condition that could result in minor injury if the user fails to read, understand and follow the safety information.

 **NOTICE**

Indicates information that the user should pay special attention to but is not related to physical injury.

Always carry out a complete check before riding. Thoroughly read the safety section.

Electric Bicycles can be dangerous to use. The user or consumer assumes all risk of personal injuries, damage, or failure of the bicycle or system and all other losses or damages to themselves and others and to any property arising as a result of using the electric bicycle.

Never disassemble, modify or replace electrical parts.

Always wear an approved helmets when you are riding to protect your head in a fall. It is your responsibility to familiarize yourself with the laws of where you ride your YOUNG ELECTRIC bicycle and comply with all applicable laws.

If you are riding at night or in bad weather

Wear reflective and bright color clothing and/or a reflective vest. Check your bicycle headlight and white reflector are in place and function properly. Check your rear red reflectors and wheels reflectors are also in place.

Extra precautions must be taken if you will be riding your bike in the rain. Braking distances increase during rain, visibility and tire traction are reduced. Allow extra stopping distance and take extra caution in the rain and on wet surfaces. Avoid riding the bike on ice and in snow.

Access to pathways, responsible riding and code of good riding.

Do not consider access to pathways guaranteed. Your behavior on your next ride will influence accessibility to pathways in the years to come. Limit skidding, avoid muddy areas and remain courteous to walkers and horse riders.

 **WARNING**

All frames and components should be checked regularly Inspect for signs of wear and/or essential breakage (cracks, corrosion, breaks). These are important safety verifications to avoid accidents, body injuries and that your bike continues to last and give you pleasure.

ASSEMBLY INSTRUCTIONS

● YOUNG ELECTRIC Bicycle Assembly Checklist

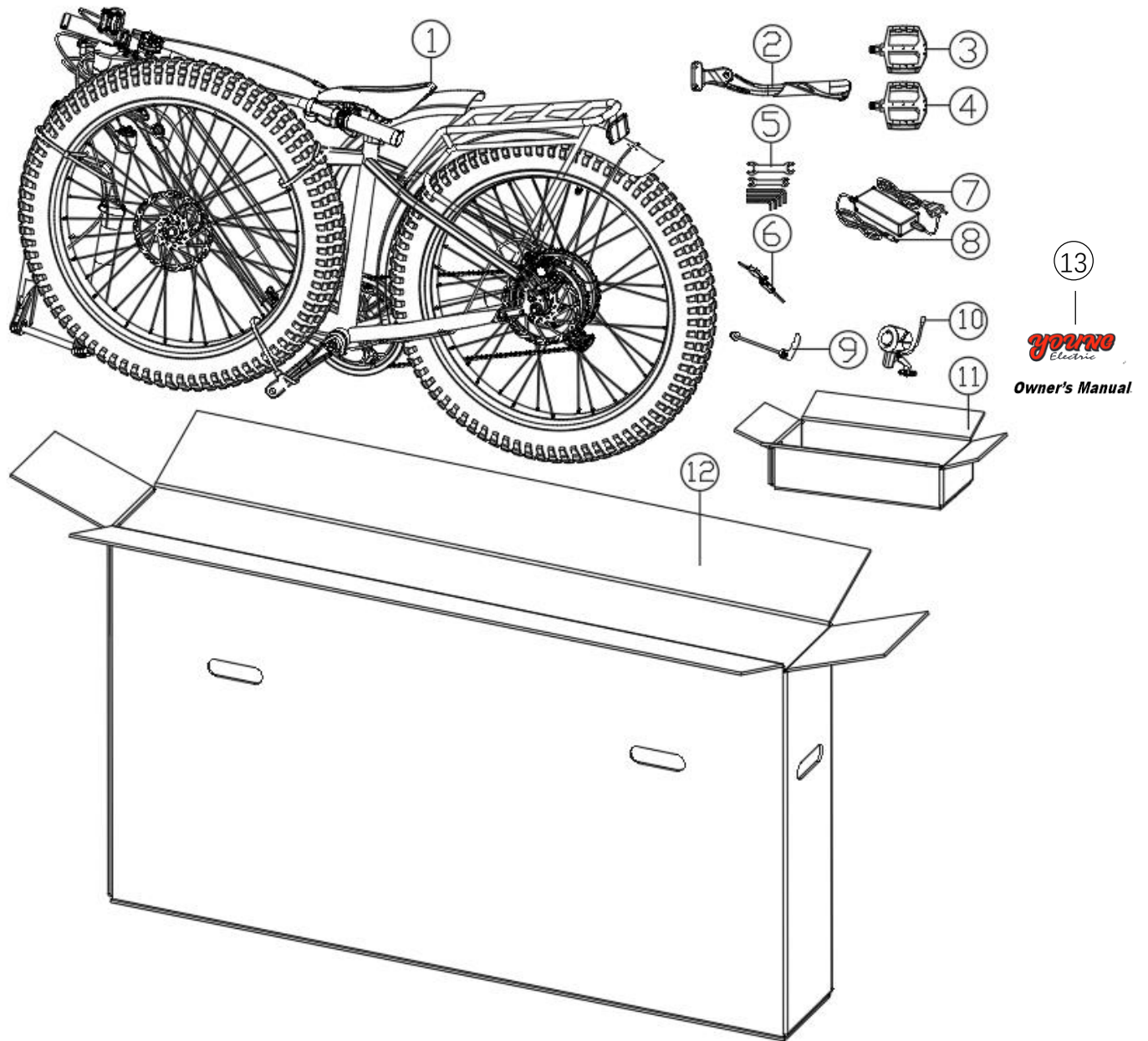

1	E-Bike	4	Right Pedal	7	Charger	10	Headlight	13	Owner's Manual
2	Kickstand	5	Tools kit	8	Cable	11	Accessory Box		
3	Left Pedal	6	Key x 2	9	Quick Release Lever	12	Master Carton		

● YOUNG ELECTRIC Bicycle Assembly Guide

⚠ NOTICE

The following assembly information is only a general guide to assist during the assembly of YOUNG ELECTRIC bikes. It is not a complete or comprehensive manual of all aspects of the bike assembly, maintenance, and repair. Consult a certified bike mechanic to assist with the assembly, adjustment, repair, and maintenance of YOUNG ELECTRIC bikes.

Step 1: ATTACH THE KICKSTAND

Open the shipping carton and carefully remove your bike the bottom tray. Get the kickstand from the accessory box. The kickstand comes with 2 screws. Remove the screws from the kickstand with the M4 hex key. Position the kickstand behind the frame. Then start to thread the screws in with your fingers into the threaded holes on the kickstand. Once they are in finish tightening them with the M4 hex key.

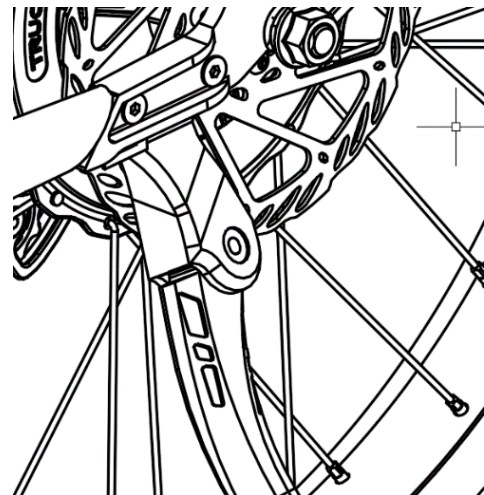
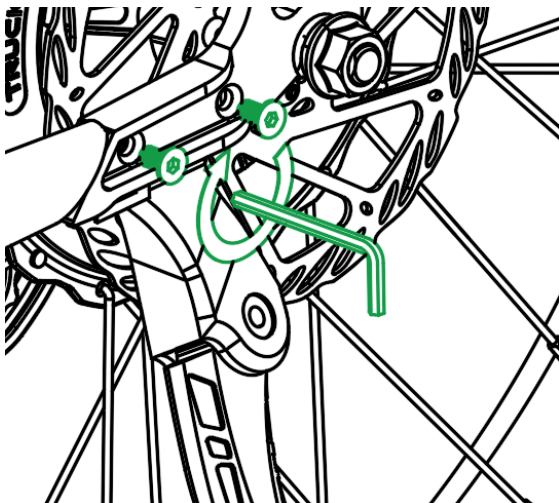
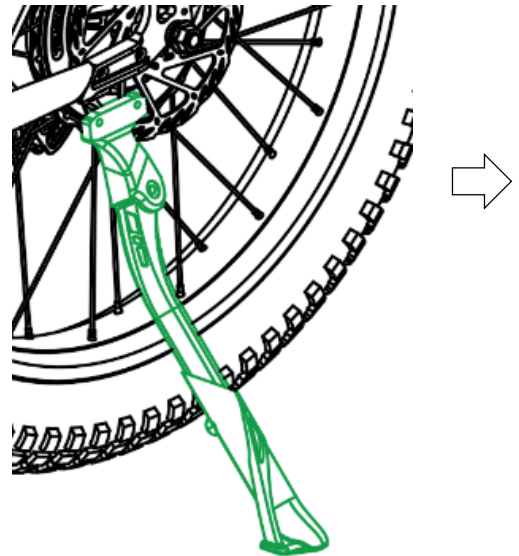
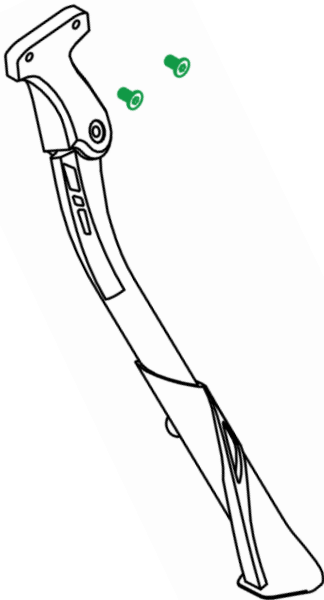

Step 1

Step 2: PREPARE TO ATTACH THE FRONT WHEEL

Gently place it on a soft surface to prevent scratches during assembly.

Remove all zip ties and inside protective covers or packing materials. (scissors not included)

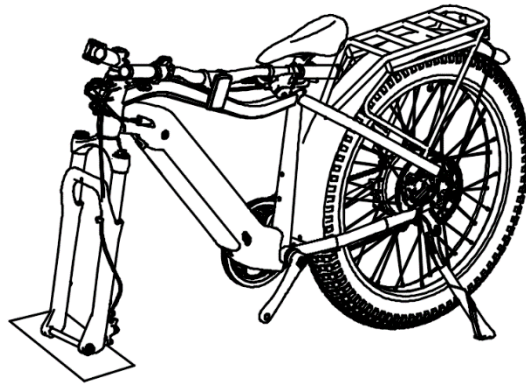
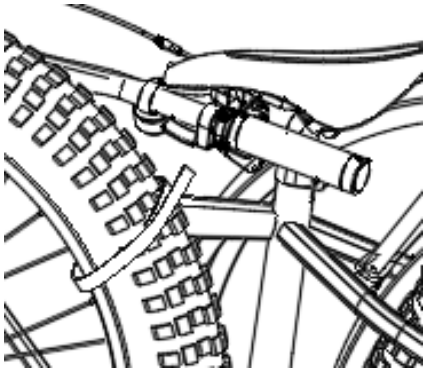

Step 2

Step 3: ATTACH THE FRONT WHEEL

Remove the quick release front axle from the accessory box. Then remove the bracket from the front forks and remove the plastic caps from the front wheel hub. Insert the front wheel into the front fork dropouts making sure the brake disc is centered in the brake caliper to avoid any damage. Unscrew the nut from the quick release axle and be sure to not drop the springs. Place 1 spring on the axle with small part facing inward and insert the quick release front axle into the front wheel from the brake disc side. When placing the 2nd spring and nut back on the other side be sure to press the axle towards the side you are about to install the 2nd spring and nut on. This will allow room for the spring and nut. Follow the same step for when placing the 2nd spring as you did on the first spring. Then tighten the nut being sure to not over tighten it. You need to be able to flip the quick release lever up to lock it into place. The lever should be stiff but not so stiff you can not flip it up to ensure tightness. Do not use any tools for this process. There should be no play in the front wheel. If you have play, it is not tight enough.

WARNING

All quick-release levers should be inspected before every ride to be sure they are fully closed and secure. Failure to properly close a quick-release lever can cause loss of control of the bicycle resulting in injury or death. Make sure the wheel is properly seated and the quick-release lever is properly closed.

● Assembly explosion diagram

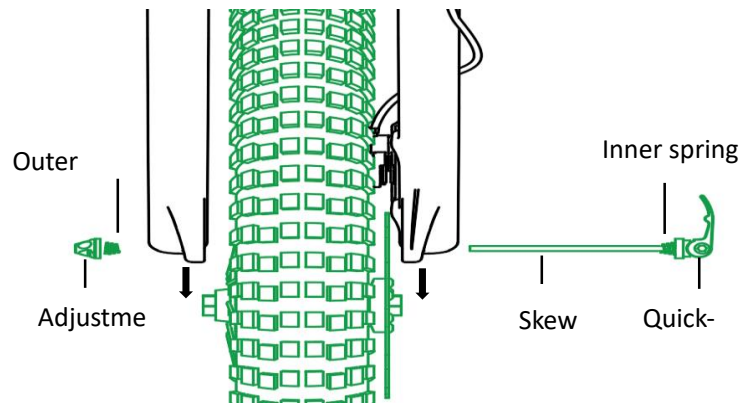

● Installation guide

- ① Remove plastic caps from front wheel hub.
- ② Unscrew the adjustment nut from the skewer, remove outer spring and slide the skewer through the front wheel axle so the quick-release lever is on the same side of the chain.
- ③ Slide the wheel into the fork dropout slots. Insert the disc rotor into the center of the disc brake at the same time you are inserting the wheel axle into the fork drop out.
- ④ Insert the skewer into the hub. Begin to thread the adjustment nut back onto the skewer, but do not tighten too far.
- ⑤ Move the quick-release lever into the open position. With one hand on the quick-release lever and one hand on the adjustment nut, start to hand tighten the adjustment nut until you start to feel some resistance against the fork.
- ⑥ Try to close the quick-release lever. If it closes easily, open it up and tighten the adjustment nut further. If it is too difficult to close, open the quick-release lever up and loosen the adjustment nut a little and try again. Do not attempt to tighten by turning the quick-release lever. The quick-release lever is for closing, the adjustment nut is for adjusting the tension.

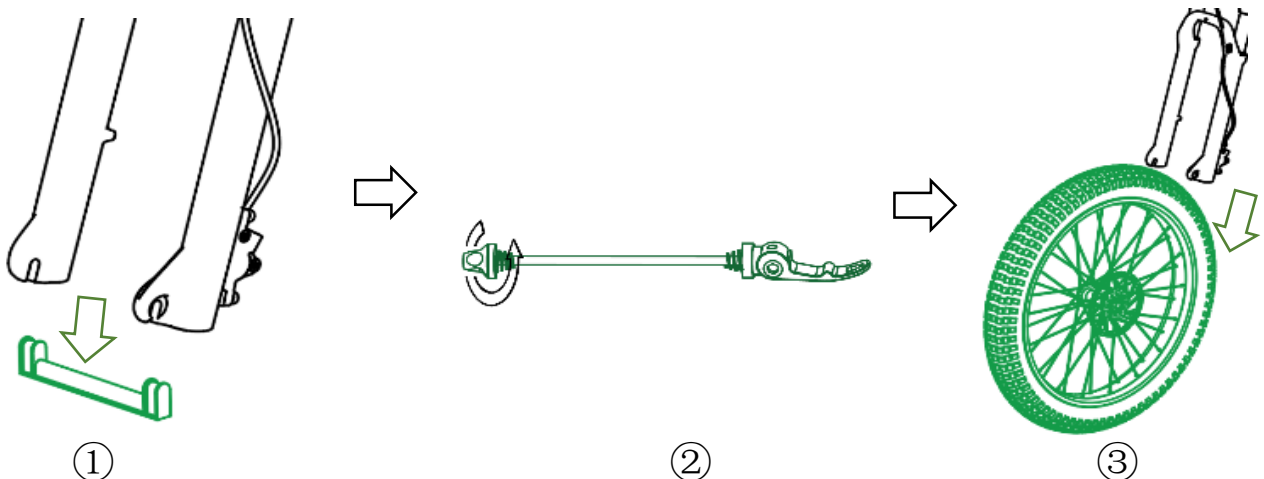

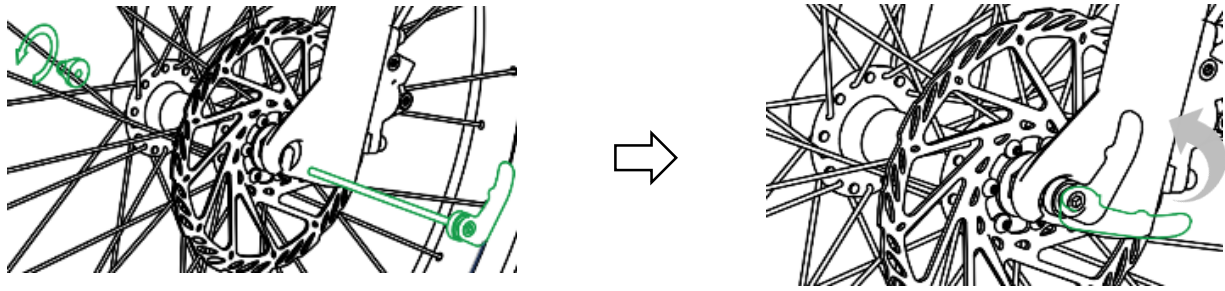

④

⑤

Important!

Only tighten the quick-release with the adjustment nut.

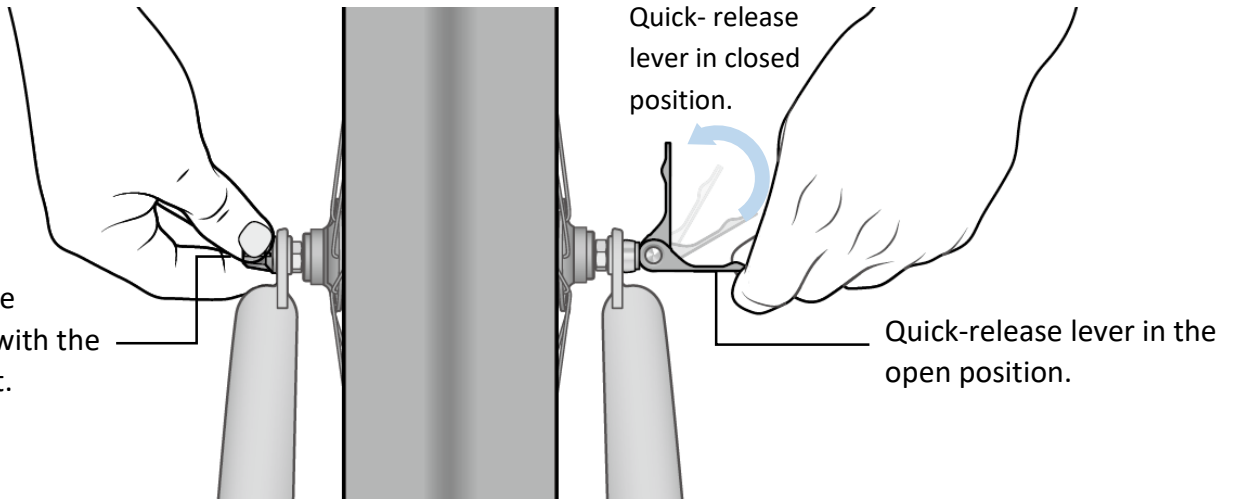

Quick-release lever in closed position.

Quick-release lever in the open position.

⑥

Step 3

Important! You should feel resistance when you close the quick-release lever that should leave a temporary impression on your fingers. Open and close the handle to ensure the wheel is securely locked in place.

Step 4: ATTACH THE HANDLEBAR

Remove the handlebar clamp from the stem by removing all screws with M5 Allen wrench. Insert the handlebar into the stem and reinstall the clamp. Make sure the handlebars are aligned with the front wheel before tightening and the stem is not set above the maximum height indicator. Tighten all screws evenly in crosswise pattern. Make sure handlebars are in preferred position before final tightening of screws. Tighten the 2 bolts on the stem. Make sure all screws are tightened evenly to ensure maximum stability of handlebars.

⚠ WARNING

Make sure all fasteners used to secure the handlebars and stem are torqued according to specification. Loose handlebars could cause the rider to lose control and result in serious injury. Do not extend any component beyond any minimum insertion mark. Damage to bike, property, serious injury or death could occur.

● **Installation guide**

①—② Remove all four stem faceplate bolts with M4 hex key.

③—④ Place the handlebar on the stem correctly. Center the handlebar and screw in the four stem faceplate bolts evenly, however do not tighten all the way down for further adjustment.

Tighten 4 screws in diagonal with M4 hex key . (A → B → C → D)

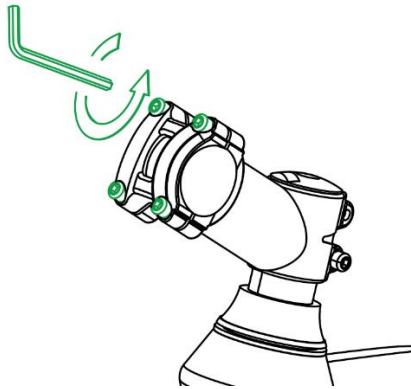

①

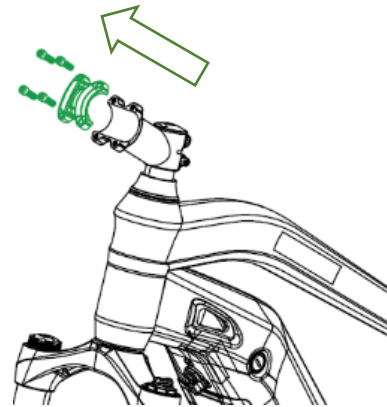

②

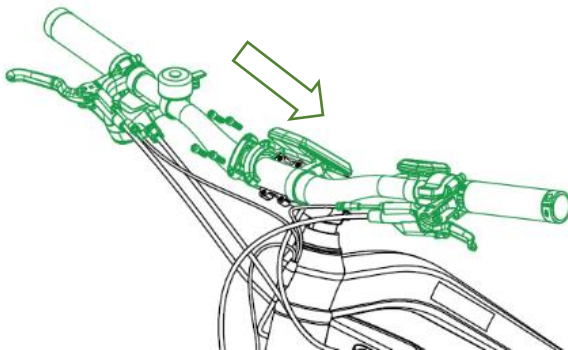

③

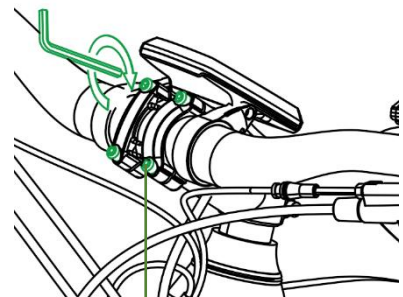

④

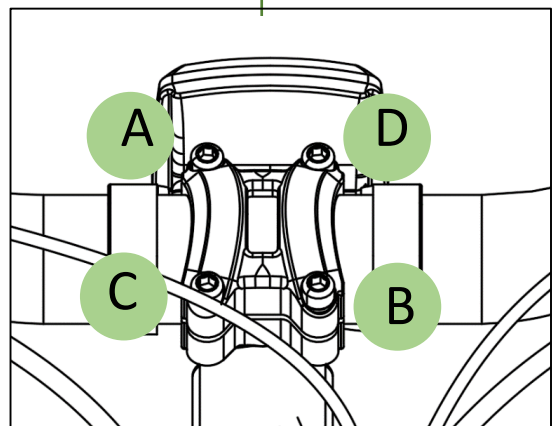

Step ④

Step 5: ATTACH THE PEDALS

⚠ NOTICE

The pedals are marked “L” for left and “R” for right. Also, the cranks are marked with “L” and “R” for visually pairing your pedals to the correct side. The “L” pedal is reverse thread when you are trying to thread it in. Attaching the wrong pedal to the wrong side will cause irreparable damage. Before your first ride, please check to ensure your pedals are attached correctly and tight.

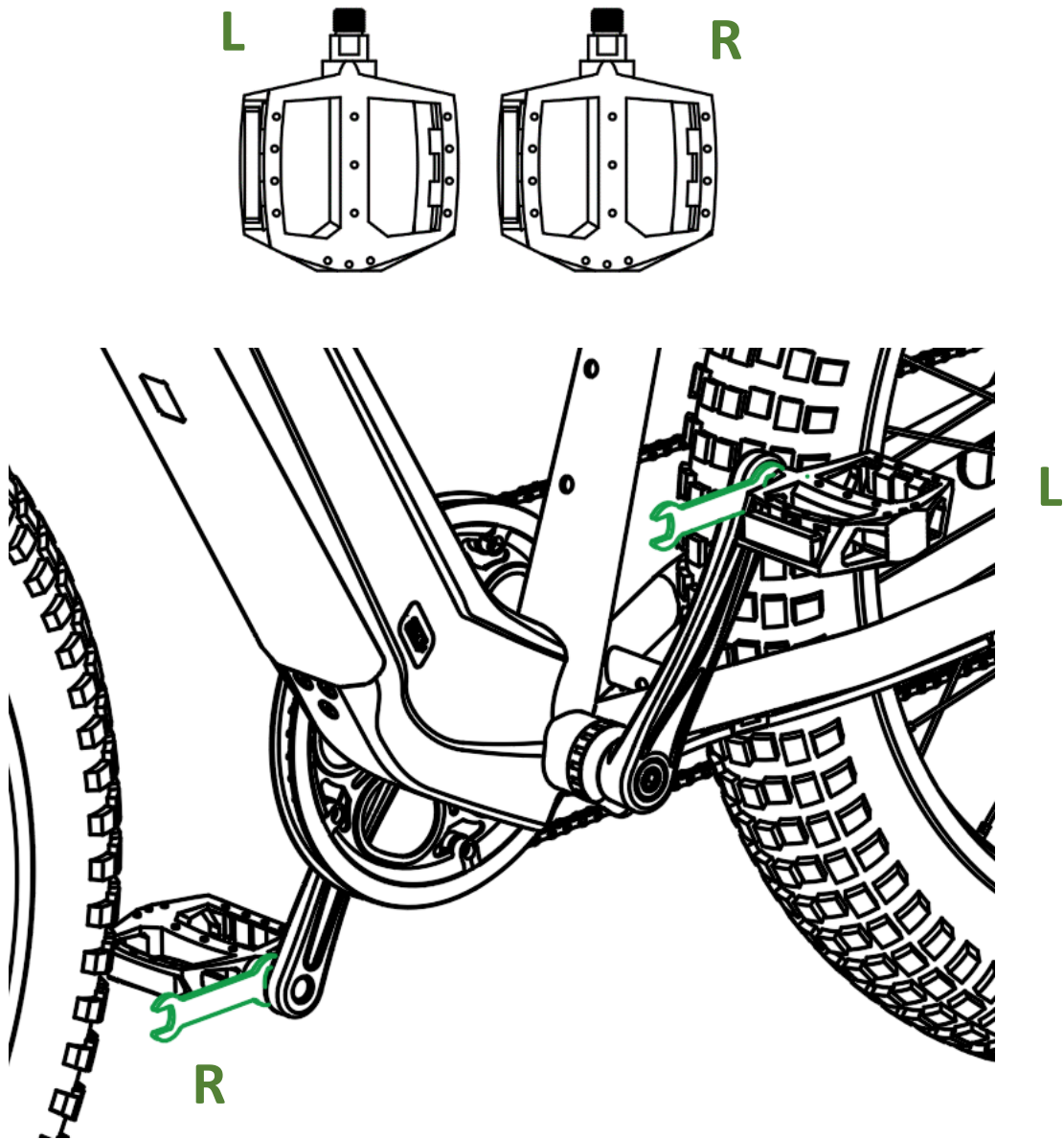

Step 5

Step 6: ATTACH THE FRONT FENDER AND HEADLIGHT

⚠ NOTICE

After plugging the waterproof connector of the cable, tighten the nut on the plug to be sure to align the upper arrow of the two connectors, and tighten the screw .

- ① Take the front fender and pass through the shoulder of the front fork from the front of the front wheel.
- ② Position the front fender so the fender bracket is on the inside of the frame. Align the hole in the bracket to the hole in the front of fork crown.
- ③ Loosen screw on the bottom of fork and insert the screw through the hole of the fender struts.
- ④ Tighten the screws with M4 hex key.
- ⑤ Unscrew the nut and gasket at the end of the long bolt and position the headlight bracket so the bracket is on the inside of the frame. Align the hole in the bracket to the hole in the back of fork crown. Pass the long screw through the hole in the fork along with the headlight bracket.
- ⑥ Tighten the screwed nut to the end of the long screw with M5 hex key and 10mm open wrench.

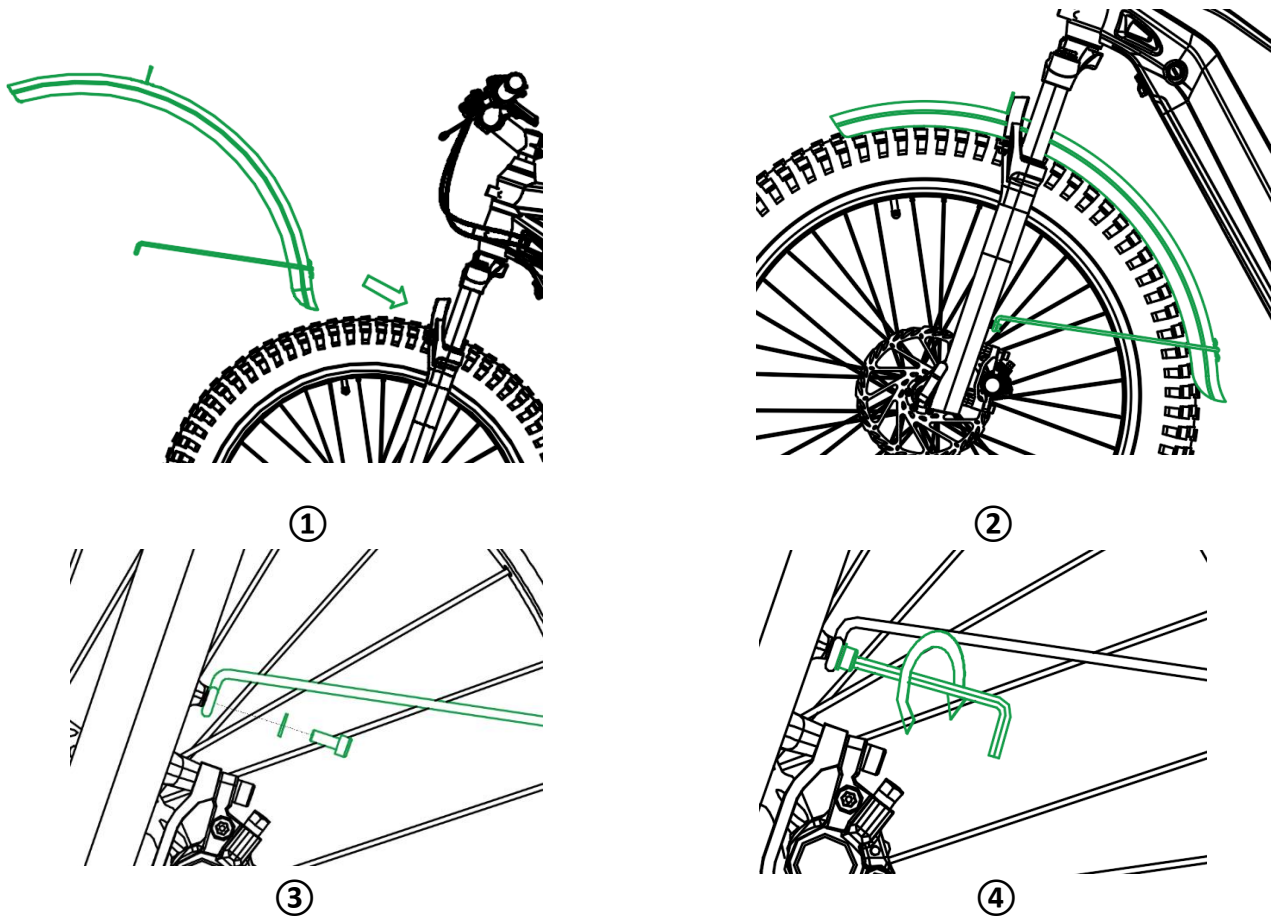

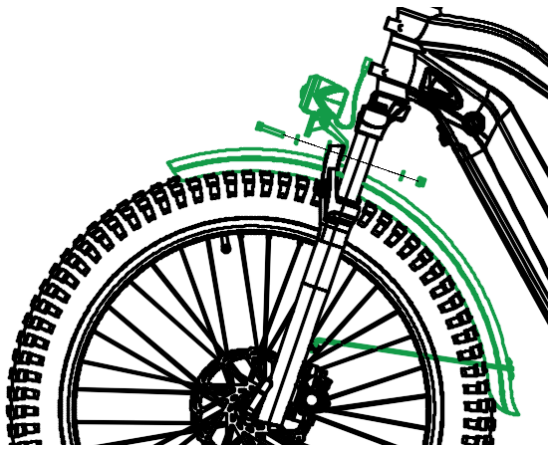

⑤

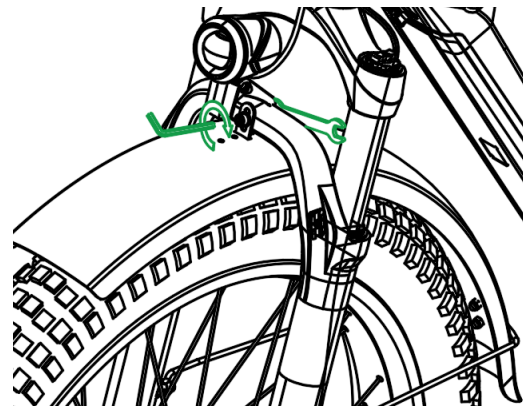

⑥

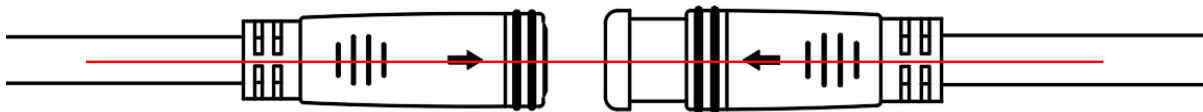

Connect Headlight : Keep the arrows aligned and insert the connectors plug

Step ⑥

Step 7: ADJUSTED SEAT HEIGHT

- ① Unlock the quick-release lever and insert the seat post into the seat tube.
- ② Adjust the seat height up or down until the rider feels they have control of the bicycle and are comfortable.
- ③ Close the quick-release lever and lock the seat in place. If there is not enough pressure to hold the seat in place open the quick-release lever. With one hand on the quick-release lever and one hand on the adjustment nut, start to hand tighten the adjustment nut until you start to feel some resistance against the post clamp. Do not attempt to tighten by turning the quick-release lever. The quick-release lever is for closing, the adjustment nut is for adjusting the pressure.

NOTICE

The seat assembly should be adjusted with the seat centered on the rails and level.

It is recommended to add some grease to all threads and binders on a bicycle, especially on the outside of the seat post. Otherwise it may corrode over time and not be able to be adjusted again.

WARNING

Improperly adjusted seat height could affect the rider's ability to reach the handlebar and pedals resulting in unexpected movement, loss of control and serious injury or death. Follow these guidelines when adjusting the seat height. Always ensure the seat post minimum insertion marks are below the seat clamp and cannot be seen. Ensure the seat clamp is locked and the seat cannot move.

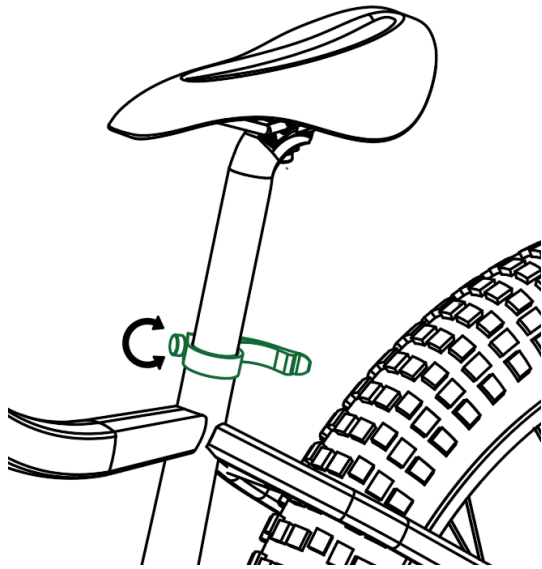

①

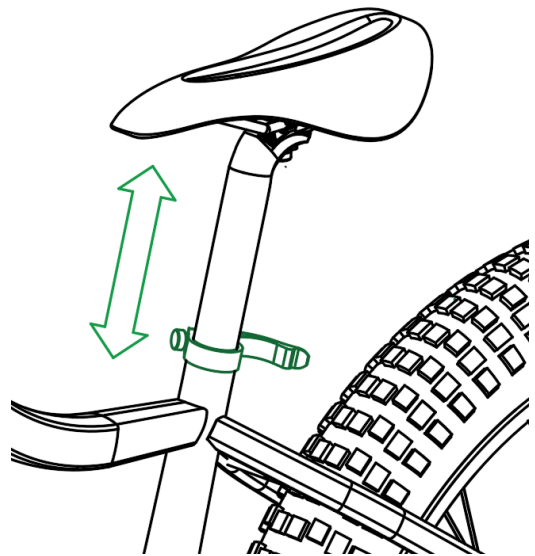

②

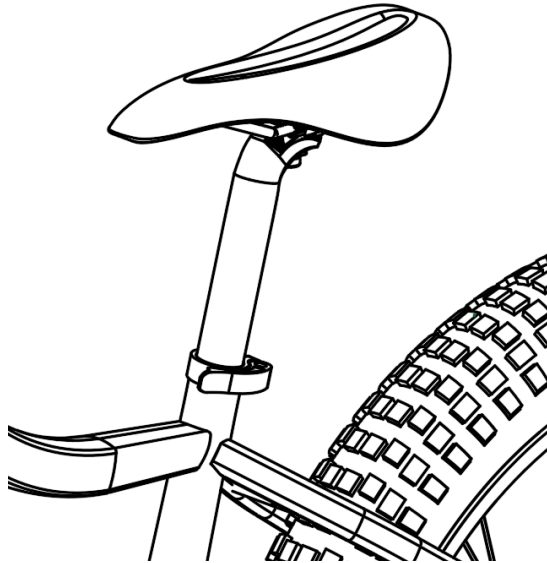

③

Step 7

Torque Specs			
Item	Nm	Item	Nm
Handlebar	5Nm	Seat post Clamp	6-8 Nm
Stem	8Nm	Pedals	25Nm

Step 8: BATTERY REMOVAL AND INSERTION

The battery must be installed by sliding the battery forward in the battery holder. The key locks the battery to the bike when the key is turned clockwise to the locked position. The battery must be locked when riding or it may fall out. The key does not have to be in to operate the bike.

- ① Insert the key and turn left to open the first lock.
- ② Turn the safety lock in the direction of the arrow shown while holding the top of the battery with your other hand.
- ③ As shown in the picture, carefully remove the battery.
- ④ When installing the battery, first insert the low end of the battery into the internal slot of the downtube to ensure that the terminals at the bottom of the battery and the slot inside the downtube are inserted smoothly. Then push the upper end of the battery into the downtube and turn the key to the right to lock it.



unlock ①



unlock ②



Remove ③



Installing ④

Step 8

Step 9: TURNING THE E-BIKE ON AND OFF

ON : By pressing and holding the button , the display will start to work and the working power supply of the controller will be turned on. If YOUNG ELECTRIC bikes is not used for more than 10 minutes, the display will be automatically powered off.

OFF : In the power-on state, by pressing the button , YOUNG ELECTRIC bikes will be powered off. In the power-off state, the display will no longer use the battery power, and its leakage current will be less than 1uA.

Thumb Throttle : Bike can works on the assist level 1-5 except on 0 level when use the thumb throttle.

Headlight : on/off

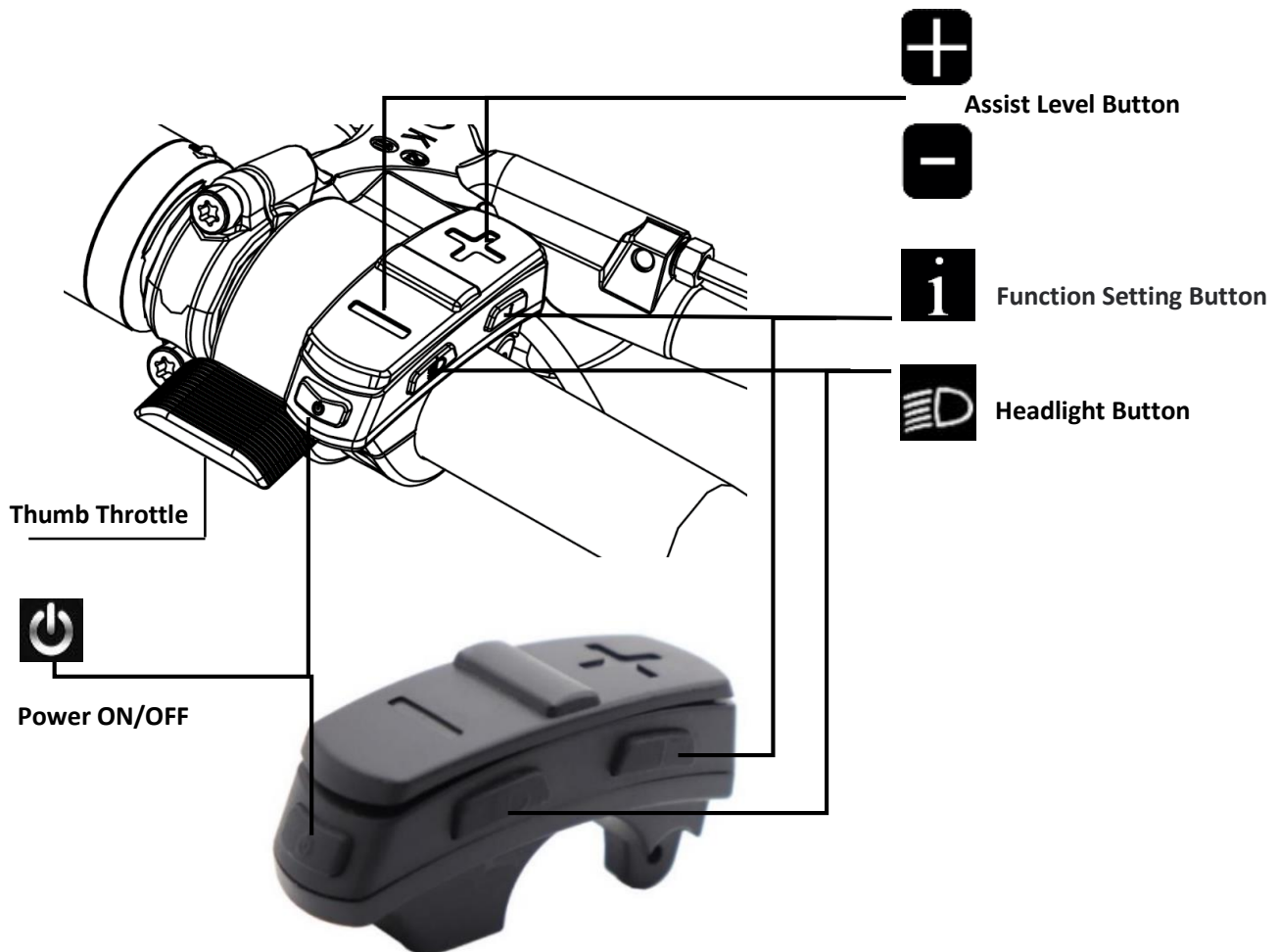

Step 9

Step 10: USING THE MOTOR ASSIST LEVELS

- **Motor Assist Mode:**

1. Throttle Assist Mode (No Assist on PAS 0); The power output is determined by the rotation of the thumb throttle. None of the PAS level are associated with the throttle when using the throttle assist mode .
2. Pedal Assist Mode (PAS 1-5) ; The power output from motor gradually increases on PAS 1-5 level. The maximum power output from motor will be on PAS 5 level and the minimum power output from motor will be on PAS 1 level.

 **NOTICE**

Note: Every pedal-assist level (PAS 1-5) has the highest speed limitation as below, when the speed is over the highest speed, the ebike will power off.

FOR USA MARKET: Motor: 750W; Battery: 48V,20AH (960Wh);

	Class 2 (Max Speed 20MPH)	Class 3 (Max Speed 28MPH)
Pedal Assist Level	Max Range	Max Range
PAS 1	80 miles (129 km)	80 miles (129 km)
PAS 2	70 miles (113 km)	75 miles (121 km)
PAS 3	55 miles (89 km)	65 miles (105 km)
PAS 4	45 miles (72 km)	60 miles (97 km)
PAS 5	40 miles (64 km)	50 miles (80 km)

FOR CANADA MARKET: Motor: 500W; Battery: 48V,20AH (960Wh);

Pedal Assist Level	Max Range
PAS 1	162 km (103 miles)
PAS 2	125 km (78 miles)
PAS 3	105 km (64miles)

PAS 4	87 km (54miles)
PAS 5	70 km (44miles)

- **PAS Assist Level Changing:**

By pressing the button **+**/**-**, the e-bike assist level will be switched to change the motor output power.



Assist Level Switching Interface

Step **10**

BATTERY CHARGING & STORAGE

● Battery Charging

⚠ NOTICE

Only use the battery charger that is provided with your e-bike to charge the battery. Connect the charger input plug (110/240-volt plug) to the power outlet.

The red indicator light turns on and will remain red until it is fully charged. The indicator light turns green once the battery is fully charged and please unplug the AC plug from power outlet first.

- ① Open the charger cover.
- ② Plug the charger into the battery's charging port , Insert the charger probe into the charger port on the e-bike battery **before plugging charger into power outlet.**
- ③ Insert the pronged end of the battery cord into the battery charger. Insert the AC plug into an AC outlet.
- ④ The YOUNG ELECTRIC battery may be charged while on the bike or removed and charged at a location away from the YOUNG ELECTRIC bike in a dry location.

Plug the charger into the battery's charging port before plugging charger into power outlet .

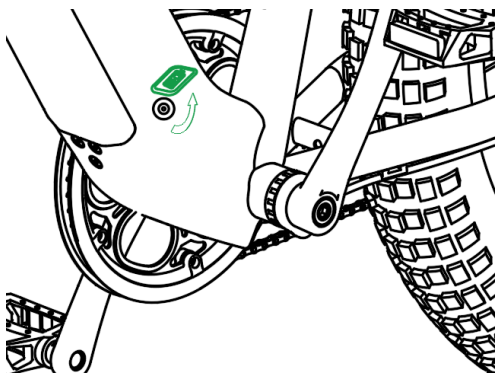

①

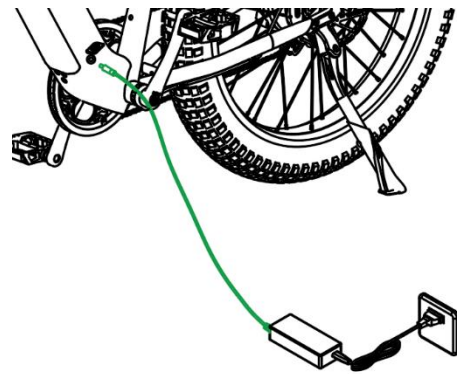

②

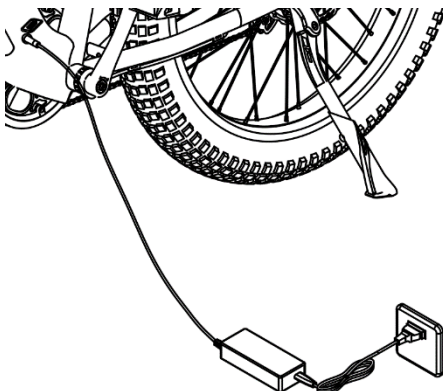

③

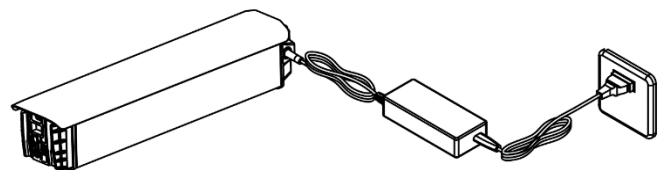

④

● Battery Storage

CAUTION

- Deep discharge of the battery may cause the internal short circuit. Heating the battery to very high temperature may cause fire.
- Avoid deep discharge during the use and storage of battery.
- When not in use, the battery shall be fully charged once every 2 months at least.
- Do not carry a deep-discharged battery on the E-bike.
- If the E-bike or the battery is not used for a long time, comply with the following instructions:
 - a. Do not store the battery in the environment with temperatures below -20°C (-4°F) or above 45°C (113°F).
 - b. Do not expose the battery in an environment with fluctuating temperature. The ideal storage temperature range is between 10°C (50°F) and 25°C (77°F).
 - c. Protect the battery against moisture to avoid the corrosion of electrical contacts. It shall be stored in a dry environment.
 - d. Do not store the battery near the flammable items.
- The battery will switch to offline in the following cases:
 - a. E-bike is not in use for 2 months.
 - b. The battery is completely depleted and/or is not charged for 2 months.
 - c. Completely charge before returning battery and bike to normal use.

● Battery Information

Follow these instructions to guarantee a longer battery life.

- Ideally, the battery shall be charged at ambient temperature close to 20°C (68°F). Battery should be close to ambient temperature before starting charge cycle.
- Avoid frequent full discharge. Battery life is improved with only partial discharge. Lithium-Ion battery cells used in your battery do have memory that can reduce battery capacity. Regardless, if battery is in-use or not, the cell oxidation will be caused by the usage and aging, and the battery capacity will be reduced as battery becomes old.
- Deep discharge will cause irreversible damage and capacity loss for the battery. If the battery is not used for a long time, it must be fully charged at least once every 2 months.
- Do not put the battery in water.
- The battery and charger shall not be repaired. Do not try to disassemble or modify the battery or charger.
- Do not use a battery with a damaged case.
- Keep the battery away from children.
- Stop using the battery immediately if become hot to touch, dissipates a strong odor, or has a distorted housing.

● Battery Charging Information

WARNING

- A damaged, wet, or dirty power cable or socket may cause electric shock that can be fatal injury. Avoid using dirty, wet, or damaged power cables.
- Stop charging battery immediately if it becomes too hot to touch, emits a strong odor, or has any other signs of overheating.
- When charging, ensure no flammable material is near the battery since it may generate heat.
- Put the charger and battery on a non-flammable surface for charging. To charge a battery installed on the Electric bicycle, put the Electric bicycle in an environment with no flammable materials nearby.
- Do not charge the battery on a carpeted floor.
- Do not cover the battery and charger during charging.
- Use the battery charger provided with the product only.
- Use a dry and undamaged power cable and charger only.
- Replace a damaged power cable or charger immediately.
- Before connecting a power cable, remove foreign matters at the charger port, such as dust, ice, and snow.
- Applying the other charger which is not provided by the product may cause battery overheating and explosion.
- When not in use, the battery shall be fully charged once every 3 months at least.
- Do not expose the battery in the environment with storage temperatures below -20°C (-4°F) or above 45°C (113°F). Note: The temperature above 60°C (140°F) may cause the internal structure overheating, especially in the environment under direct sunlight.
- Do not use the charger in a humid environment or in the environment with temperatures below -10°C (14°F) or above 40°C (104°F).
- Stop charging battery immediately if it becomes too hot to touch, emits a strong odor, or has any other signs of overheating.

● Charger Information

The provided charger is suitable for the voltage range of 100-240V. Switching the voltage range of the charger is not required as it will automatically detected supply voltage. There is not any switch on the charger. Unplug the charger when not in use.

 **WARNING**

Charge the battery only with the charger originally supplied with the bike or a replacement Young Electric charger. Never use an aftermarket charger which can result in battery damage, property damage, serious injury, and/or death.

● **Charger Connection**

Put the battery on a solid non-flammable surface when in use. The battery and charger should be laid flat on surface so ports and plugs are horizontal. Otherwise, the charge port and plug connecting to the socket may be damaged in other ways. To check the present Battery Capacity, turn on the system, and the information will be shown on the instrument. Unplug battery and charger when not in use.

Connect the charger to the battery, and the indicator on the charger shows red light to indicate that the battery is charging. A completely discharged battery will required about 5.5 hours to be fully charged. After charging is complete, the indicator on the charger shows green light

There is not any switch on the charger. Disconnect the battery when it is completely charged. Do not push the bicycle pedals when the battery is charging on the bicycle. The charge socket on the battery may be damaged. The battery can be charged when on or off the bicycle but must not be moved during charging cycle.

 **WARNING**

If battery pack is partially or totally submerged in water it will suffer damage that compromises its safety and stability. This damage can be even more severe if battery pack was submerged in salt water. Attempting to charge a compromised battery can lead to severe injury or death.

UNDER NO CIRCUMSTANCES should you attempt to charge a battery pack that has been partially or totally submerged in water. Attempting to charge a compromised battery can result in a very dangerous fire that generates significant heat, toxic gasses and is extremely difficult to control.

Check your bike as soon as possible after partial or complete submersion. Most likely its electrical system has been damaged and is unsafe to use. Carefully remove battery pack from bike and take it to a safe location OUTDOORS, away from flammable materials.

To properly dispose of the battery, place in clear plastic bag and take it to your municipal household hazardous waste drop-off center. To find the closest facility in your area check with your local City Hall or Fire Department or go to

<https://www.call2recycle.org/locator/>.

Failure to adhere to these safety warnings can lead to severe injury or death.

PRE-RIDE CHECK

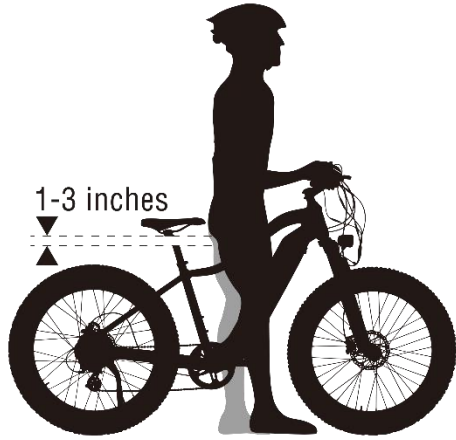

PROPER FRAME SIZE:

For safe and comfortable riding there should be a clearance of at least 1-3 inches between the crotch of the intended rider and the top tube of the bicycle frame, while the rider straddles the bicycle with both feet flat on the ground. If there is less than 1-3 inches clearance, the bicycle is too large for the rider and should not be used.

Check the following every time before you mount your bike:

Safety Check	Basic Steps
Wheels and Tires	<p>Ensure the tires are inflated to the recommended limits specified on tire side wall. Inspect tires to ensure tread is good, have no bulges or cuts, and have no embedded objects that may puncture it.</p> <p>Ensure rims have no damage, run true, do not wobble, have dents or kinks.</p> <p>Ensure all spokes are tight and are not broken.</p> <p>Make sure axle nuts or quick release levers are tight. Ensure the locking lever of all quick release assemblies are secure.</p> <p>Ensure that reflectors are securely in position on both wheels.</p>
Brakes	<p>Ensure front and rear brakes function properly.</p> <p>Test that the brake levers move freely, are firm, and do not touch the handlebar grips when pulled with maximum hand force.</p> <p>Ensure the motor cutoff and brake light functions properly.</p> <p>Ensure the brake pads are positioned correctly, move freely, and do not have excess wear.</p> <p>Inspect the brake rotors to make sure they are not damaged, have objects tangled in them, or have excess wear.</p> <p>Ensure brake cables are adjusted correctly, are lubricated, and have no obvious damage.</p> <p>Ensure brake caliper fasteners are secure, they are not leaking fluid, and do not have damage.</p>
Steering	<p>Ensure the handlebars and stem are correctly adjusted, fasteners are tight, and turn freely.</p> <p>Ensure the handlebars and stem are set correctly in relation to front wheel.</p>

	Ensure both handlebar grips are secure and do not have excess wear.
Chain	Ensure the chain is clean, well lubricated, and runs smoothly. Make sure chain does not make any unusual noises or squeaks. Make sure there is no foreign material lodged in the chain links or excessive corrosion.
Bearings	Ensure the bearings in the headset, lower bracket, pedals, and both wheels turn freely. Inspect for excess movement, rough feeling, grinding, rattling, and noise.
Cranks and Pedals	Make sure both pedals are securely tightened to the crank arms. Ensure the pedals turn freely, not bent or damaged in any way. Make sure the crank arms are securely fastened to bottom bracket shaft and are not bent.
Rear Derailleur, Shifter, and cable	Check that the derailleur is adjusted and function properly. Ensure the shifter is functioning properly when shifting up and down through gears. Ensure the chain is not making noise in all gears. Ensure the derailleur is moving freely. Does not have any object tangled in it, and shift cable tightly secured to it. Ensure the shift cable is not damaged in any way and is properly adjusted.
Frame, Fork, and Seat	Make sure the frame and front fork are not bent or damaged in any way. Inspect frame and fork for any cracks in the paint at welded joints. This can indicate damage to the frame or a broken weld. Make sure the seat is properly adjusted and the quick release is securely tightened. Ensure both wheels are evenly spaced in the front fork and rear frame.
Motor and Rear Wheel Assembly	Ensure the hub motor spins smoothly in both directions. Ensure the motor power cable is not damaged and secured well to the frame. Ensure the hub motor bolts are tight and there is no sign of damage to the rear drop outs. Ensure the spokes are tight and do not appear to be damaged in any way.
Battery	Make sure the battery is fully charged before using the bike. Inspect the battery to ensure there is no damage to the battery, the electrical connectors are in good condition, and the mounting features are in good condition. Insert battery into lower mount and rotate it into the upper mount. Make sure battery is held firmly in position by lock. Pull lightly on the battery to make sure it will not come out after locking to frame. Turn on the HMI display to confirm battery is engaged and fully charged.

<p>Electrical Cables and Lights</p>	<p>Inspect all visible electrical connectors to confirm they are connected completely. Make sure all electrical cable grommets are in the proper position to prevent damage to electrical and mechanical cables. Ensure insulation on cables is not damaged and there are no exposed wires. Carefully inspect cables that pass under bottom bracket to make sure cables are not damaged under the bike. Turn on the bike to ensure the headlight, taillight, and brake lights are functioning properly.</p>
<p>Accessories , Other, and PPE</p>	<p>Ensure all reflectors on bike are properly secured and visible. Ensure rear rack and any other items are securely fastened to the frame. Ensure the fenders and mounting hardware are secure. Make sure the kick stand is functioning properly and fasteners are tight. Inspect the helmet and any other PPE to ensure they are not damaged and function properly. Ensure the rider is wearing a helmet, other required PPE, and is familiar with riding laws.</p>

HMI DISPLAY CONTROL

WARNING





When riding the Electric bicycle, using the Power Assist or Controls may distract you. It may reduce your control on the E-bike and cause unexpected injury. The components should only be accessed under proper traffic conditions. Access the information after parking the E-bike in a safe place. Top speed 20MPH(32KM/H) by throttle only, Top speed 20MPH(32KM/H) or 28MPH (45KM/H) by pedal only base on your local legal requirements.

Changing Power Assist level on a slippery surface could cause you to lose control. Avoid changing Power Assist levels when on slippery surfaces. Reduce speed and use extra caution if level must be changed when on slippery surface.

1. Appearance





● Button definitions

There are five buttons on the operating unit of display, the on/off button , plus button , minus button , headlight button  and switching button .

2. General Operation

● Power on/off



By pressing and holding the button , the display will start to work and the working power supply of the controller will be turned on. In the power-on state, by pressing the button , YOUNG ELECTRIC bikes will be powered off. In the power-off state, the display will no longer use the battery power, and its leakage current will be less than 1uA.

- **Assist level selection**

By pressing the button , the e-bike assist level will be switched to change the motor output power. There are 5 levels .

- **Push assistance**

By pressing and holding the button  for 3 second, the electric push assistance mode will be enabled.

YOUNG ELECTRIC bikes will run at the constant speed of 6km/h. The display will show . pressing and holding the button  for 3 second , YOUNG ELECTRIC bikes will immediately stop power output and return to the state before push assistance.



Push Assistance Indicator Interface

The push assistance function can only be used when you are pushing YOUNG ELECTRIC bikes. Please do not use it during riding.

3. Function Display

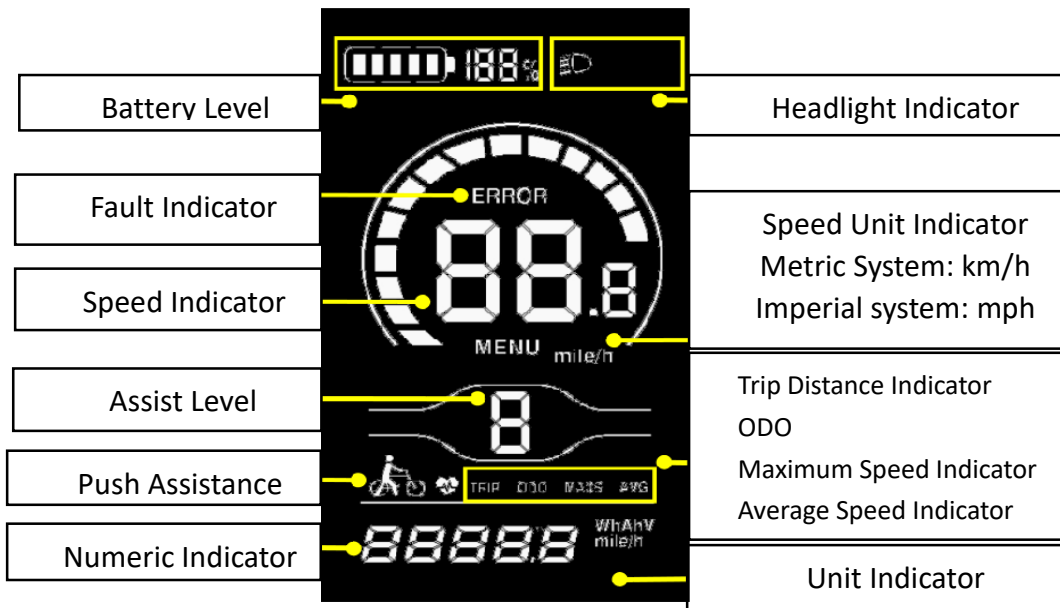

- **General Setting**

Press the button **i** to enter the parameter modification interface. Press the button **+** / **-** for parameter selection. Press the button **i** to save the parameter and return to the selection interface of general setting options.

- **Number Represents Function**

When display is working at first, the speed and TRIP DIST after the display is turned on; Press the **i** button in turn to query the cycling project, and the query items include: RIP DIST, ODO METER, Maximum Speed and Average Speed.

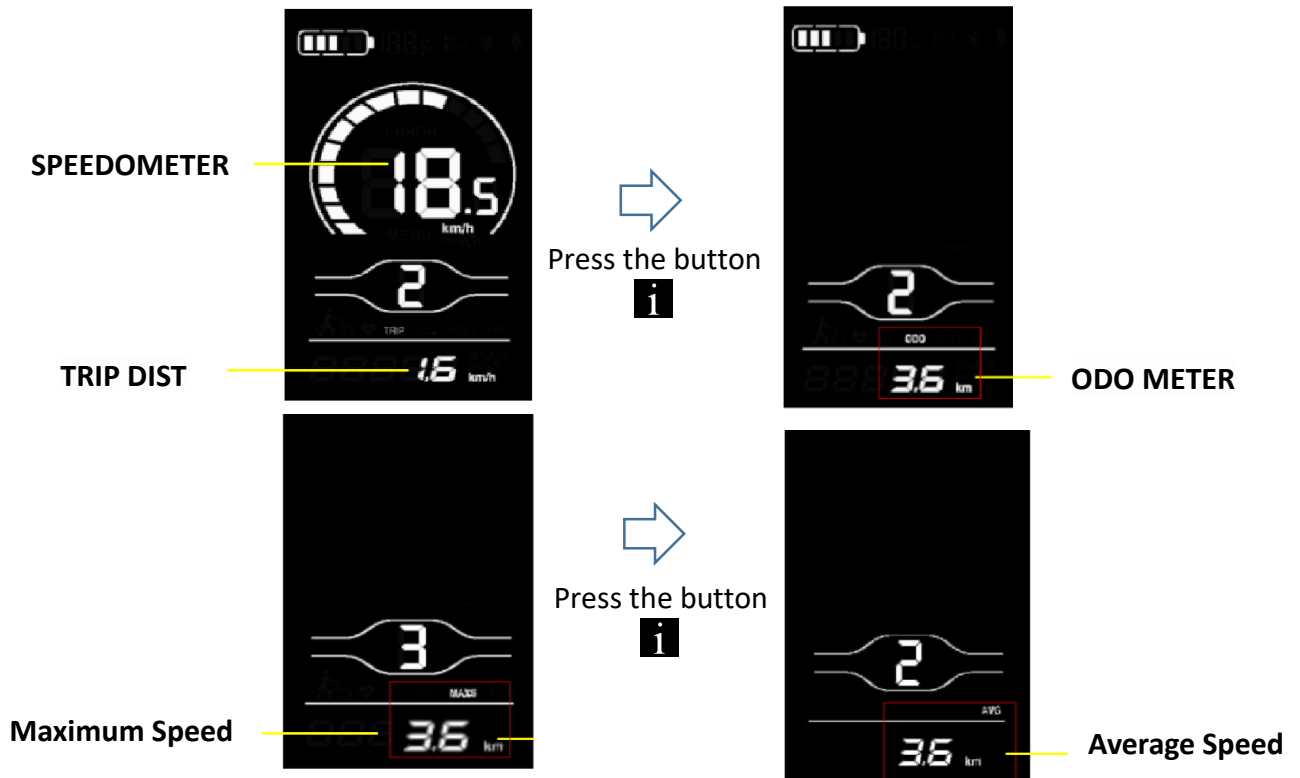

● Battery Level Indicator

The battery level indicator consists of five segments. When the battery is fully charged, the five segments will be all on. In case of undervoltage, the outline of the battery indicator will flash, which means the battery has to be charged immediately.



Full battery level indication

4-segment indication

3-segment indication

2-segment indication

1-segment indication







Undervoltage flashing

● Speed Limit Unlocking (Class 2 OR Class 3)



Customers who unlock their YOUNG ELECTRIC bike to Class 3 mode are responsible for checking that they use their e-bikes in compliance with their local laws. YOUNG ELECTRIC bike can not take responsibility for any legal liabilities associated with using the bike in Class 3 mode.

- 1) Press the  button to turn on HMI display and the speed "0" was show on screen.
- 2) Press and hold the  and  button at the same time for more than 2 seconds to enter personalized settings interface.
- 3) Press the  or  button to select the setting interface "05P" as show below , the selectable range of the maximum speed setting value is 20mph (32km/h) and 28mph (45km/h) .

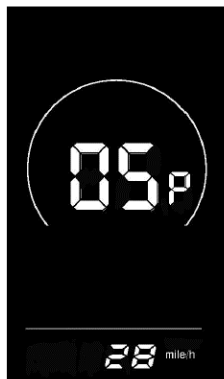

Speed Limit setting interface

- 4) Press the **i** button to enter the setting interface and the unit number will flash, then press the **+/-** button to choose the speed number you want.
- 5) Press the **i** button to confirm and back to Initial interface, At this point, you've completed the speed limit unlocking steps.
- 6) Repeat the above steps to restore Class 2 ;

MAINTENANCE:

Basic Bike Care

To ensure safe riding conditions you must properly maintain your bike. Follow these basic guidelines and see a certified bike mechanic at regular intervals to ensure your bike is safe for use and fun to ride.

Properly maintain batteries by keeping them fully charged when between uses of two weeks or more apart. See the Long-Term Battery Storage section for information on storing the battery for longer than two weeks between rides.

- Never immerse or submerge the bike or any components in water or liquid as the electrical system may be damaged.
- Periodically check wiring and connectors to ensure there is no damage and the connectors are secure.
- To clean, wipe the frame with a damp cloth. If needed, apply a mild non-corrosive detergent mixture to the damp cloth and wipe the frame. Dry by wiping with a clean, dry cloth.
- Store under shelter; avoid leaving the bike in the rain or exposed to corrosive materials. If exposed to rain, dry your bike afterward and apply anti-rust treatment to chain and other unpainted steel surfaces.
- Riding on the beach or in coastal areas exposes your bike to salt, which is very corrosive. Wipe down your bike frequently and wipe or spray all unpainted parts with anti-rust treatment. Damage from corrosion is not covered under warranty so special care should be given to extend the life of your bike when used in coastal areas or areas with salty air or water.
- If the hub and bottom bracket bearings have been submerged in water or liquid, they should be taken out and re-greased. This will prevent accelerated bearing deterioration.
- If the paint has become scratched or chipped to the metal, use touch up paint to prevent rust. Clear nail polish can also be used as a preventative measure.
- Regularly clean and lubricate all moving parts, tighten components, and adjust as required. Regularly inspect all pre-attached and optional component hardware to ensure proper torque spec, secure attachment, and good working condition.

Carrying Loads

The maximum weight limit for the YOUNG ELECTRIC bike is 330 lbs.(149kg) That weight limit includes the weight of the rider and all items carried on the bike. The rear rack weight limit is 59 lb.(27 kg)

WARNING

- Never exceed the rated weight limit of the bike or rear rack. Exceeding rated limit can damage the bike or rack. Damage to bike may cause rider to lose control of bike and result in serious injury.
- Never carry passengers on this bike. Passenger may fall from the bike or become injured by moving parts.
- Never carry oversized objects on the bike that may interfere with rider. Oversized objects may cause rider to lose control and result in serious injury.

Cleaning Your E bike:

WARNING

- Never immerse the bike in or any of the components in water or other liquid. This can damage the electrical system and will void your warranty.
- Never clean the bike with high pressure jetted water. This can enter the electrical components and damage them.
- Always store the bike in a dry location. Thoroughly dry the bike after riding in the rain or washing it. Standing water can enter electronics or cause corrosion resulting in damage to the electrical system.

Remove the battery pack from your bike before cleaning the bikes. Use a damp cloth with mild soap as needed to clean the outside of the battery. Do not insert anything into the electrical connector on battery for any reason. These should remain clean and dry when the bicycle is properly cared for.

The bike can be cleaned with water from a garden hose, mild dish soap, and a damp cloth. Avoid spraying electronics on the handlebars, electrical connectors, ends of the hub motor where axle protrudes, rear cassette, front sprocket and chain. Rinse soap away thoroughly with low pressure water. Thoroughly dry the bike and pay extra attention to remove any water from electrical components or connectors. Low pressure air from a hair drier or shop vacuum can also be used to help remove water from places that are difficult to reach.

Reinstall the battery after the bicycle has been cleaned and thoroughly dried. Make sure the battery is properly installed and locked into the bike.

• **Tire Inflation And Replacement:**

See the side wall of your bike tires for the proper size tire for your bike. These tires use a rubber inner tube to retain air pressure. The tires on your bike are designed for typical terrain and surfaces the bike was intended to be used on. Only replace the tires with a similar tire design of the same size. Always check all items related to Tires and Wheels listed in the Pre-Ride Check before each ride. Properly inflated tires will help to ensure your best bike performance, longest range possible, and maximum life of the tires.

Keep your tires inflated to 5-30 P.S.I. at all times. Never exceed the maximum pressure listed on the tire side wall. Tires will lose air pressure over time. Always check tire pressure before operating the bike. Low tire pressure can result in damage to the wheels that will be more difficult and expensive to repair.

Always replace your tires with equivalent tires with reflective side walls. Your YOUNG ELECTRIC bike was equipped from the factory with this type of tire to provide the most visibility of you and your bike in low light conditions. Keep the tires clean to ensure the reflective side wall can function properly.

Recommended Service Intervals

Regular inspection and maintenance are key to ensure lasting bike function as intended, and to reduce wear and tear on their systems. Recommended service intervals are meant to be used as guidelines. Real world wear and tear, and the need for service, will vary with conditions of use. We generally recommend inspections, service, and necessary replacements be performed at the time or mileage interval that comes first in the following table.

Interval	Inspect	Service	Replace
Weekly, 100-200 mile (160-321 km)	<ul style="list-style-type: none"> -Check hardware for proper torque -Check drivetrain for proper alignment and function (including the chain, freewheel, chainring, and derailleur). -Check wheel trueness and for quiet wheel operation (without spoke noise). -Check condition of frame for any damage. 	<ul style="list-style-type: none"> -Clean frame by wiping frame down with damp cloth. -Use barrel adjuster(s) to tension derailleur/brake cables if needed. 	<ul style="list-style-type: none"> - Replace any components confirmed by YOUNG ELECTRIC Product Support or a certified bike mechanic to be damaged beyond repair or broken.
Monthly, 250-750 mile (402-1207 km)	<ul style="list-style-type: none"> -Check brake pad alignment, brake cable tension. -Check bike is shifting properly, proper derailleur cable tension. -Check chain stretch. -Check brake and shifter cables for corrosion or fraying. -Check spoke tension. -Check accessory mounting (rack mounting bolts, fender hardware, and alignment). 	<ul style="list-style-type: none"> -Clean and lubricate drivetrain. -Check crankset and pedal torque. -Clean brake and shift cables. -True and tension wheels if any loose spokes are discovered. -Balance the battery. 	<ul style="list-style-type: none"> - Replace brake and shift cables if necessary. - Replace brake pads if necessary.

Every 6 Months, 750-1250 mile (1207- 2011 km)	-Inspect drivetrain (chain, chainring, freewheel, and derailleur). -Inspect all cables and housings.	-Standard tune-up by certified, reputable bike mechanic is recommended. -Grease bottom bracket.	-Replace brake pads. -Replace tires if necessary. -Replace cables and housings if necessary.
---	---	--	--

Troubleshooting

Symptoms	Possible Cause	Most Common Solution
Bike does not work	<ol style="list-style-type: none"> 1. Depleted/Very Low battery charge 2. Faulty connections 3. Battery not fully seated in connector 4. Improperly turned on 5. Blown Discharge Fuse in battery 6. Brakes applied or stuck 	<ol style="list-style-type: none"> 1. Charge the battery 2. Clean or repair connector 3. Reinstall battery and ensure completely seated 4. Review manual, follow start procedure 5. Replace with new fuse on same size 6. Disengage/free brakes
Reduced Range	<ol style="list-style-type: none"> 1. Low tire pressure 2. Low or faulty battery 3. Riding with too many hills, excessive load, headwind, applying brake while riding 4. Battery was left discharged for long period of time without regular charging, aged, damaged or unbalanced cells. 5. Brakes adjusted improperly 	<ol style="list-style-type: none"> 1. Adjust tire pressure 2. Check connections and/or fully charge battery 3. Assist bike with greater pedal effort, Change route, reduce load on bike. 4. Balance the battery. Contact Customer Service or Authorized Service shop if reduced range persists. 5. Adjust the brakes to eliminate drag when brake levers are not pulled, ensure calipers and/or pads can move freely
Irregular acceleration and/or reduced top speed	<ol style="list-style-type: none"> 1. Insufficient battery power 2. Loose or damaged throttle/PAS controller 3. Damaged torque sensor in bottom bracket 	<ol style="list-style-type: none"> 1. Charge or replace battery 2. Replace Throttle/PAS controller 3. Contact Authorized Service shop for repair
Motor does not respond when bike is powered on	<ol style="list-style-type: none"> 1. Loose/damaged wiring connection 2. Loose/damaged throttle/PAS control 3. Loose or damaged motor wires/plug 4. Damaged motor 	<ol style="list-style-type: none"> 1. Repair and/or reconnect 2. Tighten or replace 3. Secure, repair, or replace damaged wires 4. Contact Authorized Service shop to replace

Battery will not charge	<ol style="list-style-type: none"> 1. Charger not connected well/completely 2. Charger damaged 3. Battery damaged 4. Wiring damaged 5. Blown battery fuse 	<ol style="list-style-type: none"> 1. Adjust the connections 2. Replace 3. Replace 4. Repair or replace 5. Reset circuit breaker or replace fuse
Wheel or motor makes strange noises	<ol style="list-style-type: none"> 1. Loose or damaged wheel spokes or rim 2. Loose or damaged motor wiring 3. Debris interfering with wheels 	<ol style="list-style-type: none"> 1. Tighten, repair, or replace 2. Reconnect or replace motor 3. Remove debris and inspect for damage

Error Code



Please use safely, and do not plug or unplug the display when it is powered on.

- Please avoid bumping as far as possible.
- Please do not alter the background parameter settings of the display at will, otherwise normal riding cannot be guaranteed.
- If the display fails to work normally, it should be repaired as soon as possible.

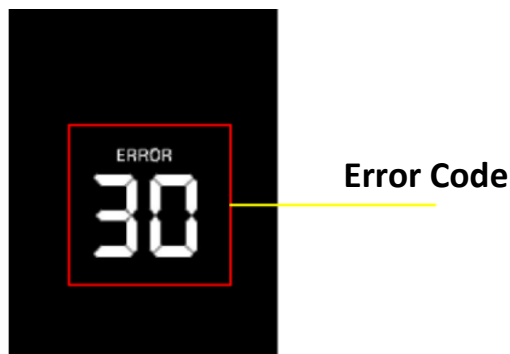

Error Code	Definition
05	Throttle Fault
07	Over voltage Protection
08	Motor Hall Signal Fault
09	Motor Phase Fault
14	Controller Fault
23	Headlight Fault
30	Communication Fault

SERVICE PARTS

FZJ-12803011
E-Scout Pro Exploded Diagram V2.0

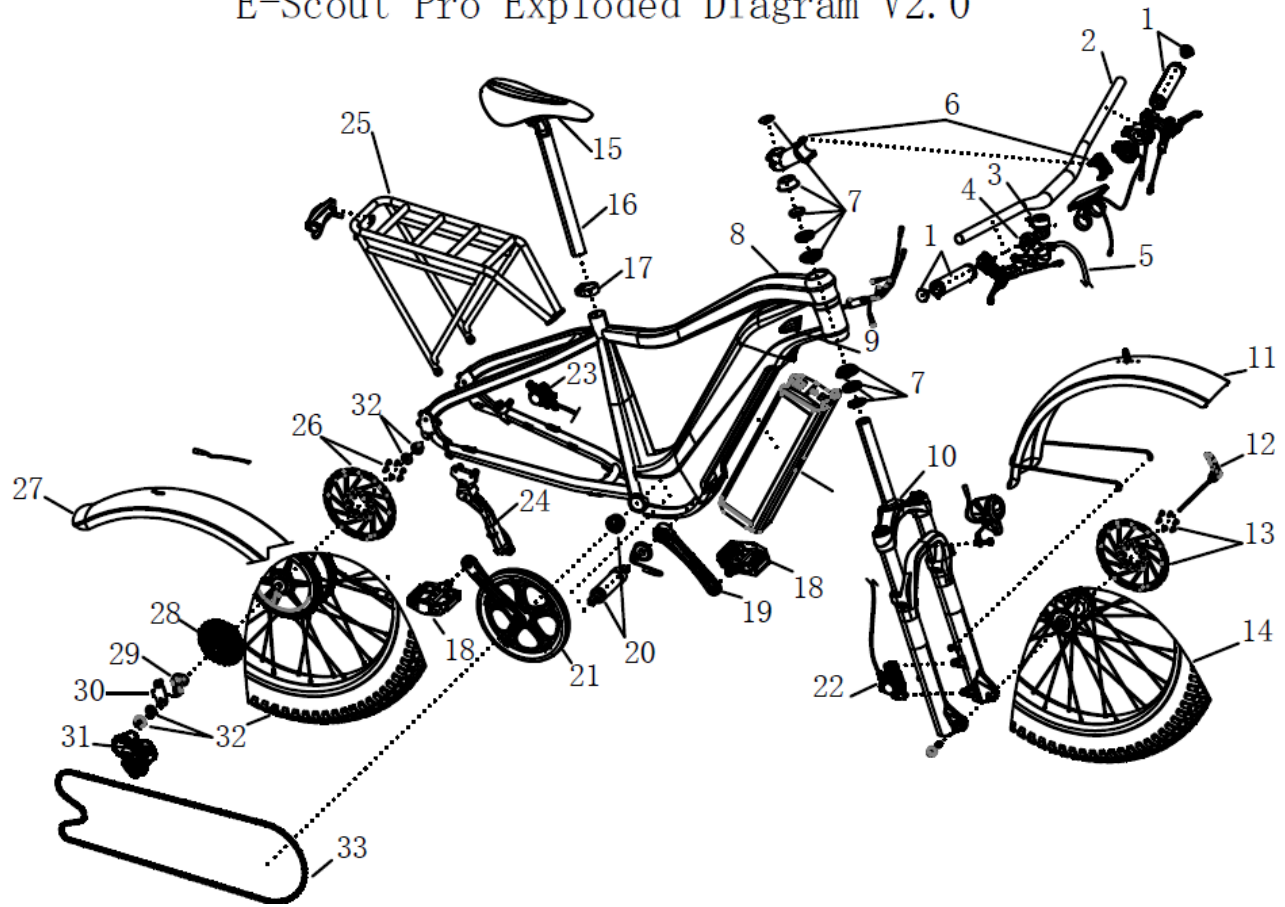

1	Grip	2	Handlebar	3	Bell	4	Shift Lever	5	Derailleur Wire
6	Stem	7	Headset	8	Frame	9	Rubber plugs for crossing the wire	10	Front Fork
11	Front Fender	12	Quick Release	13	Front Rotor	14	Front Wheel Set	15	Saddle
16	Seatpost	17	Seat Clamp	18	Pedal	19	Crank Arm	20	Bottom Bracket
21	Chain Ring	22	Front Brake Caliper	23	Rear Brake Caliper	24	Kickstand	25	Rear Rack
26	Rear Rotor	27	Rear Fender	28	Cassette Sprocket	29	Derailleur Hanger	30	Claw Protection
31	Derailleur	32	Rear Wheel Set	33	Chain				

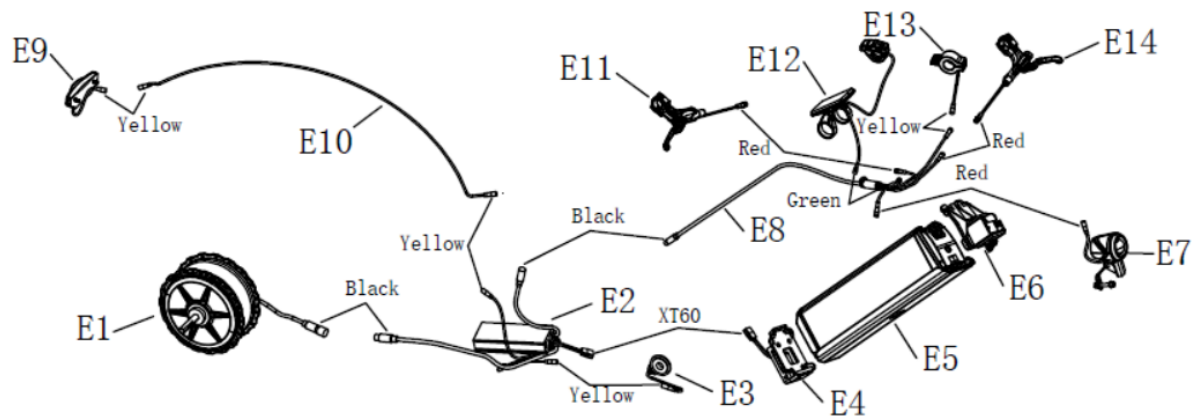

E1	Rear Hub Motor	E2	Controller	E3	Speed Sensors	E4	Discharge Base	E5	Lithium Battery
E6	Battery Holder	E7	Headlight	E8	Cable with five branches	E9	Taillight	E10	Taillight Cable
E11	Hydraulic Disc Brake Lever (Rear)	E12	HMI Display	E13	Throttle	E14	Hydraulic Disc Brake Lever (Front)		

Limited Warranty

WARRANTY REGISTRATION CARD

Owner Name:

Address:

City, State, Zip, Country:

Phone:

Model:

Color:

Size:

Electric bicycle Serial Number:

Battery Serial Number:

Model:

Color:

Dealer Name

Address:

City, State, Zip, Country:

Date of Purchase:

Length of Warranty

Every bicycle has a useful product lifespan. This limited warranty is not meant to suggest or imply that the frame or components can never be broken or will last forever. This limited warranty covers manufacturing defects that occur within the normal lifespan and use of the product.

For YOUNG ELECTRIC E-bike, the serial number is the singular certificate for after-sales (warranty). Before purchasing, please check the serial number in detail. In case of a worn serial number, please do not purchase the E-bike.

The electric bicycle serial number is noted on the Master Carton and the bottom tube of frame. The battery serial number is noted on the battery pack.

Warranty Conditions

This limited warranty applies only to the original owner of the bicycle and is not transferable to subsequent owners or other transferee of the electric bicycle. Only the original owner of an electric bicycle purchased from YOUNG ELECTRIC online or YOUNG ELECTRIC authorized distributor or retailer is covered by Limited Warranty. The Warranty Period begins upon your receipt of the electric bicycle and shall end immediately when any sale or transfer of the electric bicycle is made, and under no circumstances shall the Limited Warranty apply to any subsequent owner or other transfer of the electric bicycle.

Bike Frame: **5 year warranty**

All other mechanical components: **1 year warranty**

Electrical components: **2 year warranty**

For any warranty claim to be considered, the E-bike must be in an assembled, reasonably clean and sanitary condition and accompanied by the original, dated sales receipt for the bicycle (be sure to keep your receipt in a safe place!).

This limited warranty is void if the bicycle is subjected to abuse, neglect, improper repair, improper assembly, lack of proper maintenance according to the owner's manual, alteration, modification, installation of incompatible parts, corrosion, an accident or other abnormal, excessive, or improper use. This limited warranty is void if the bicycle is used in a rental or bike sharing program.

Damage resulting from normal wear and tear, including the results of fatigue, is not covered. It is the owner's responsibility to regularly inspect and properly maintain his/her bicycle. Some items that typically exhibit damage from normal wear and tear include:

- Bearings
- Tires
- Brake pads
- Handlebar Grips
- Bearing races
- Tubes
- Brake Disks
- Cables and housing
- Chain rings
- Saddles
- Wheel Hubs
- Bushings
- Cassettes
- Chain
- Spokes

Damage to a Covered Component during shipping is not covered by this Limited Warranty, but YOUNG ELECTRIC will replace such damaged Covered Components if you:

- Notify YOUNG ELECTRIC of a Covered Component damaged in the shipping process within thirty (30) days of your receipt of the electric bicycle;
- Provide YOUNG ELECTRIC with a dated picture of the damaged Covered Component;
- Return all original packaging and paperwork included with the electric bicycle;
- Note any immediately recognizable damage on the shipper's Bill of Lading prior to signing off on the shipment.

Shipping damage claims are very time sensitive and it is your responsibility to immediately inspect the electric bicycle for damage upon receipt.

Paint fading caused by the effects of ultraviolet light (UV) or outdoor exposure is not covered by this limited warranty. All labor charges for warranty service, including the transfer of components and/or any installation of new components, are the responsibility of the bicycle owner.

Due to product evolution and obsolescence (such as products that have been discontinued or are no longer kept in stock), some frames or components may not be available for older or limited edition models. In these cases, YOUNG ELECTRIC may elect to provide a replacement that it determines to be the most nearly comparable model, but sourcing and paying for components is the responsibility of the bicycle owner.

All determinations under this limited warranty will be made in the sole discretion of YOUNG ELECTRIC, including but not limited to the decision to repair or replace a defective product, and what replacement product is the most nearly comparable product then available.

THE REMEDIES STATED ABOVE ARE THE EXCLUSIVE REMEDIES UNDER THIS WARRANTY. ANY AND ALL OTHER REMEDIES AND DAMAGES THAT MAY OTHERWISE BE APPLICABLE ARE EXCLUDED, INCLUDING, BUT NOT LIMITED TO, INCIDENTAL OR CONSEQUENTIAL DAMAGES, DAMAGES TO OTHER PROPERTY, OR ANY PUNITIVE DAMAGES.

THIS IS THE ONLY WARRANTY MADE BY YOUNG ELECTRIC ON ITS FRAMES AND COMPONENTS, AND THERE ARE NO WARRANTIES WHICH EXTEND BEYOND THE DESCRIPTION HEREIN. ANY WARRANTIES THAT MAY OTHERWISE BE IMPLIED BY LAW INCLUDING, BUT NOT LIMITED TO, ANY IMPLIED WARRANTY OF MERCHANTABILITY OR FITNESS FOR A PARTICULAR PURPOSE, ARE EXCLUDED.

PLEASE REFER TO THE DOCUMENTS INCLUDED WITH YOUR BICYCLE FOR POSSIBLE FURTHER RESTRICTIONS.

THIS LIMITED WARRANTY GIVES THE CONSUMER SPECIFIC LEGAL RIGHTS. THE CONSUMER MAY ALSO HAVE OTHER LEGAL RIGHTS WHICH VARY FROM STATE TO STATE OR COUNTRY TO COUNTRY. SOME STATES AND COUNTRIES DO NOT ALLOW THE EXCLUSION OR LIMITATION OF INCIDENTAL OR CONSEQUENTIAL DAMAGES OR WARRANTIES, SO THE ABOVE LIMITATIONS OR EXCLUSIONS MAY NOT APPLY TO YOU. IF IT IS DETERMINED BY A COURT OF COMPETENT JURISDICTION THAT A CERTAIN PROVISION OF THIS LIMITED WARRANTY DOES NOT APPLY, SUCH DETERMINATION SHALL NOT AFFECT ANY OTHER PROVISION OF THIS LIMITED WARRANTY AND ALL OTHER PROVISIONS SHALL REMAIN IN EFFECT.



Distributed by Forcome Co., Ltd

Email: support@youngelectricbikes.com

Toll- Free Number: (+1) 888-933-8899/ (888) 332-8582

<https://youngelectricbikes.com/>

Version VII