



OPERATOR'S MANUAL

MODEL #100722

3500 LB. (1588 KG) WINCH



REGISTER YOUR PRODUCT ONLINE

at championpowerequipment.com



or visit championpowerequipment.com

SAVE THESE INSTRUCTIONS. This manual contains important safety precautions which should be read and understood before operating the product. Failure to do so could result in serious injury. This manual should remain with the product.

Specifications, descriptions and illustrations in this manual are as accurate as known at the time of publication, but are subject to change without notice.

TABLE OF CONTENTS

<u>Introduction</u>	3	<u>Operation</u>	13
<u>Safety Definitions</u>	3	<u>General Tips for Safe Operation</u>	13
<u>Important Safety Instructions</u>	4	<u>Self Recovery</u>	13
<u>Operation Symbols</u>	5	<u>Synthetic Rope Abrasion Sleeve</u>	14
<u>Controls and Features</u>	6	<u>Winching Techniques A-Z</u>	14
<u>Winch</u>	6	<u>Maintenance</u>	15
<u>Parts Included</u>	8	<u>Lubrication</u>	15
<u>Assembly</u>	9	<u>Synthetic Rope Replacement</u>	15
<u>Mounting the Winch</u>	9	<u>Synthetic Rope</u>	15
<u>Solenoid/Contactor Location</u>	9	<u>Specifications</u>	16
<u>Install the Rocker Switch</u>	10	<u>Performance Specifications</u>	16
<u>Wiring the Winch</u>	10	<u>Troubleshooting</u>	17
<u>Wiring Diagram</u>	12		
<u>Switch Wiring Diagram</u>	12		

INTRODUCTION

Congratulations on your purchase of a Champion Power Equipment (CPE) product. CPE designs, builds, and supports all of our products to strict specifications and guidelines. With proper product knowledge, safe use, and regular maintenance, this product should bring years of satisfying service.

Every effort has been made to ensure the accuracy and completeness of the information in this manual at the time of publication, and we reserve the right to change, alter and/or improve the product and this document at any time without prior notice.

CPE highly values how our products are designed, manufactured, operated, and serviced as well as providing safety to the operator and those around the winch. Therefore, it is **IMPORTANT** to review this product manual and other product materials thoroughly and be fully aware and knowledgeable of the assembly, operation, dangers and maintenance of the product before use. Fully familiarize yourself, and make sure others who plan on operating the product fully familiarize themselves too, with the proper safety and operation procedures before each use. Please always exercise common sense and always err on the side of caution when operating the product to ensure no accident, property damage, or injury occurs. We want you to continue to use and be satisfied with your CPE product for years to come.

When contacting CPE about parts and/or service, you will need to supply the complete model and serial numbers of your product. Transcribe the information found on your product's nameplate label to the table below

CPE TECHNICAL SUPPORT TEAM

1-877-338-0999

MODEL NUMBER

100722

SERIAL NUMBER

DATE OF PURCHASE

PURCHASE LOCATION

SAFETY DEFINITIONS

The purpose of safety symbols is to attract your attention to possible dangers. The safety symbols, and their explanations, deserve your careful attention and understanding. The safety warnings do not by themselves eliminate any danger. The instructions or warnings they give are not substitutes for proper accident prevention measures.

DANGER

DANGER indicates a hazardous situation which, if not avoided, will result in death or serious injury.

WARNING

WARNING indicates a hazardous situation which, if not avoided, could result in death or serious injury.

CAUTION

CAUTION indicates a hazardous situation which, if not avoided, could result in minor or moderate injury.

NOTICE

NOTICE indicates information considered important, but not hazard-related (e.g., messages relating to property damage).

IMPORTANT SAFETY INSTRUCTIONS

⚠ WARNING

Cancer and Reproductive Harm –
www.P65Warnings.ca.gov

⚠ WARNING

Do not use as a hoist for overhead lifting.
Do not use this winch for lifting or moving people or animals.
Never step over the cable/rope when operating under load.
Always maintain a safe distance to the opposite side of the cable/rope when operating under load.

⚠ WARNING

Never exceed the rated capacity.
Be aware that the cable/rope may break before the motor stalls.
For heavy loads at or near rated capacity, always use a snatch block to reduce the load on the cable/rope.

⚠ WARNING

Do not use the winch to secure or hold a vehicle for an extended period of time.
Always apply stop blocks to the wheels of the vehicle when on an incline.
Do not use the winch to secure a vehicle for transporting purposes.
Never move the vehicle to pull a load (towing) when operating the winch cable/rope.
Never release the free-spool clutch when there is a load on the winch.

⚠ WARNING

Disconnect the remote control and battery leads when not in use.

⚠ WARNING

Avoid “shock loads” by using the control switch intermittently to take up the slack in the cable/rope. “Shock loads” can exceed the rated capacity of the cable/rope and drum.

⚠ CAUTION

Use a winch hook strap when handling the hook for spooling or unspooling the cable/rope.

⚠ CAUTION

Always use gloves to protect hands when handling the cable/rope. Never let the cable/rope slide through your hands.

⚠ WARNING

When re-spooling the cable/rope, ensure that it spools in the under-wind position with the cable/rope entering the drum from the bottom, not the top.

To re-spool correctly, and while wearing gloves, keep a slight load on the cable/rope while pushing the remote button to draw in the cable/rope. Walk toward the winch not allowing the cable to slide through your hands. Do not let your hands get within 12 inches (30 cm) of the winch while re-spooling. Turn off the winch and repeat the procedure until a few feet of cable/rope are left. Disconnect the remote control and finish spooling by rotating the drum by hand with the clutch disengaged. Keep hands clear of the fairlead and drum while the winch is under power .

⚠ CAUTION

Do not wrap the cable/rope around any object and hook it back onto itself.

⚠ CAUTION

Duration of winching pulls should be kept as short as possible.

If the motor becomes excessively hot to the touch, stop winching immediately and let it cool down for a few minutes. Do not pull for more than one minute at or near the rated load.







⚠ CAUTION

If the motor stalls, do not maintain power to the winch.

Electric winches are designed and made for intermittent use and should not be used in constant duty applications.

Operation Symbols

Some of the following symbols may be used on this product. Please study them and learn their meaning. Proper interpretation of these symbols will allow you to more safely operate the product.

Symbol	Meaning
	Turn the clutch to the "IN" position to retract the rope.
	Turn the clutch to the "OUT" position to release the rope.
	Positive battery terminal
	Negative battery terminal
	Positive winch terminal
	Negative winch terminal

CONTROLS AND FEATURES

Read this operator's manual before operating your winch. Familiarize yourself with the location and function of the controls and features. Save this manual for future reference.

Winch

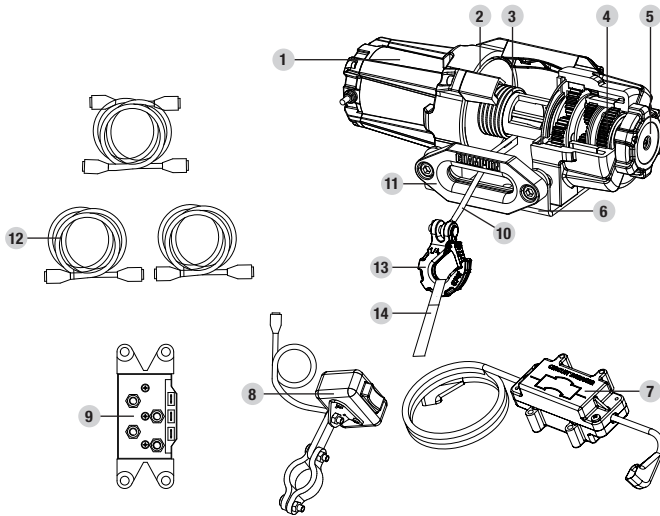

1. **Motor** – 1.2 HP (0.9 kW) 12V DC motor provides power to the planetary gear mechanism.
2. **Braking System** – Braking action is automatically applied to the winch drum when the winch motor is stopped and there is a load on the synthetic rope.
3. **Winch Drum** – The winch drum is the cylinder on which the synthetic rope is stored. It can feed or wind the rope depending on the remote winch switch.
4. **Planetary Gear System** – The reduction gears convert the winch motor power into extreme pulling forces. This system allows high torque while maintaining compact size and light weight.
5. **Free Spooling Clutch** – The clutch allows the operator to manually disengage (“Out”) the spooling drum from the gear train, free spool. Engaging the clutch (“In”) locks the winch into the gear system.
6. **Mounting Channel**
7. **Circuit Breaker** – The circuit breaker is installed as close to the battery as possible to protect in the event of an electrical fault. The assembly contains two (2) thirty amp (30A) circuit breakers that are a self-resetting, slow opening circuit breakers and are designed to protect the winch motor from an overweight pull or long full weight pull. They will simply get hot and trip in the event of an electrical fault. Once cooled down they will reset.
8. **Rocker Switch** – Rocker switch with handlebar mount for powering the synthetic rope in or out of your winch drum.
9. **Solenoid/Contactor** – Power from the vehicle battery flows through the weather sealed contactor before being directed to the winch motor.
10. **Synthetic Rope** – 3/16 in. × 50 ft. (4.8 mm × 15.2 m) Synthetic rope designed specifically for load capacity of 3,500 lb (1,588 kg). The synthetic rope feeds onto the drum in the “under wind” position through the Aluminum Hawse and is looped at the end to accept the clevis hook pin.

11. **Aluminum Hawse** – When using the winch at an angle the hawse acts to guide the synthetic rope onto the drum and minimizes damage to the synthetic rope from abrasion on the winch mount or bumper.
12. **Winch Connection Cables** – Used to connect the contactor to the winch motor.
13. **Clevis Hook** – Provides a means for connecting the looped ends of cables to an anchor.
14. **Strap** – Used to assist synthetic rope feed.

Parts Included

Assembly Parts

Part	Part Qty	Hardware	Hardware Qty	Tool(s) Needed	Torque lbf-ft (N.m)
Winch Body	1	Hexagon Head Bolt M8 x 25	4	1x 13mm wrench or socket	6.1-7 (8.2-9.5)
		Flat Washer Ø8	4		
		Lock washer Ø8	4		
Mounting Channel	1				
Aluminum Hawse	1	Hexagon Socket Set Screw M10 x 25	2	1x 8mm allen wrench	11.8-12.6 (16-17.1)
		Lock Nut M10	2	1x 16mm wrench or socket	
Mini-Rocker Switch	1	Hexagon Socket Head Screw M5 x 18	1	1x 4mm allen wrench	2.2-3 (3-4)
		Hexagon Socket Head Screw M5 x 25	2	1x 4mm allen wrench	2.2-3 (3-4)
		Flat Washer Ø5	3		
		Nut M5	3	1x 8mm wrench or socket	
Wire Tap	1				
Contactor	1	Hexagon Head Bolt M6 x 25	4	1x 10mm wrench or socket	4.1-4.9 (5.6-6.6)
		Flat Washer Ø6	4		
		Lock washer Ø6	4		
		Lock Nut M6	4	1x 10mm wrench or socket	
Battery Wires - Red (with Circuit Breaker)	1				
Battery Wires - Black	1				
Winch Wires - Yellow	1				
Winch Wires - Blue	1				
Clevis Hook	1			Needle nose pliers	
Yellow Strap	1				

ASSEMBLY

Mounting the Winch

This CPE 3,500 lb (1,588 kg) winch is designed with a bolt pattern that is standard in this class of winch. Many winch mounting kits are available that utilize this bolt pattern for the most popular trucks, SUV's and ATV's. If you cannot find a kit locally, contact CPE and we will provide you with the name of a dealer.

⚠ CAUTION

See Parts Included Assembly Parts section for torque ratings. Mounting bolts must be SAE grade 5 or better and torque to 34 ft. lbs (46 N.m).

1. Insert M10×25 (B) bolts through the mounting channel (A) holes and attach the aluminum hawse (D) to the mounting channel with the M10 lock nuts (C) provided.

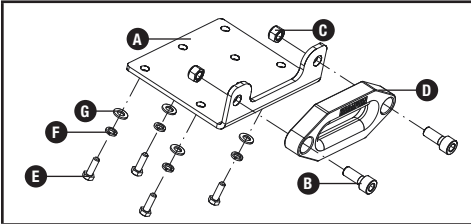

2. Turn the winch upside down. Place the mounting channel on the winch, making sure the winch is centered in the middle of it.

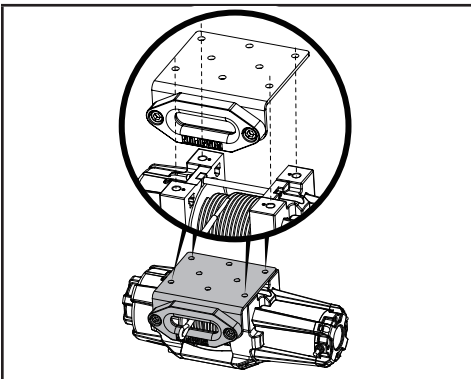

3. Thread the M8×25 (E) bolts through the Ø8 lock (F) and flat washers (G), and then thread through the mounting channel. Tighten the bolts. DO NOT over tighten.
4. Turn winch right side up. Disengage the clutch by moving the Cam Clutch Gear to the "Out" position - the arrow on the Cam Clutch Gear would be to the back of the winch as shown. Release the synthetic rope and pull through the aluminum hawse.

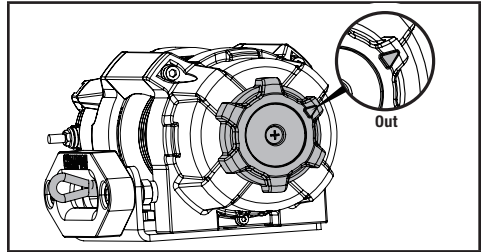

5. Attach the clevis hook to the synthetic rope, and then the hand strap to the clevis hook.

⚠ CAUTION

If utilizing a mounting plate, ensure that the three major sections (motor, drum and gear housing) are properly aligned. Proper alignment of the winch will allow for even distribution of the full rated load.

🗨 NOTICE

The type of vehicle to which the winch and mounting channel will be applied, will dictate the type of mounting kit that should be used (Speed Mount™ Hitch Adapter, Standard Mounting Channel, or Specialty Mounting Kit).

Solenoid/Contactor Location

Find a location for the solenoid/contacter. It is recommended that the solenoid/contacter be mounted close to the battery in a clean, dry location. Make sure the location chosen allows for sufficient clearance from all metal components. Drill mounting holes if required. Once a location is found, DO NOT install the unit until all wiring is completed (see wiring section).

NOTICE

Terminals coming in contact with metal will cause a direct short, possibly causing solenoid/contacter and/or battery damage.

NOTICE

Depending on the location of the solenoid/contacter, you may need to use the black and red cables in place of the yellow and blue, and the yellow and blue in place of the red and black.

Install the Rocker Switch

1. Decide which handlebar the rocker switch will be mounted on. (The rocker switch is usually installed on the left handlebar).
2. Use a piece of electrical tape (not provided) around the handlebar to help prevent rotation of the mount.
3. Tighten the rocker switch in place. DO NOT overtighten or tighten/clamp over any hoses or cables.
4. Once the rocker switch is mounted, the wires can be routed back to where the solenoid/contacter is located.
5. Make sure the handlebars have full range of motion and then secure the rocker switch's cable with the supplied cable ties.

Wiring the Winch**CAUTION**

NEVER route electrical cables across any sharp edges, through and/or near moving parts, or near parts that may become hot.

CAUTION

Battery cables should NOT be drawn tight. Leave some slack for cable movement.

NOTICE

You may need to use a test light to locate a suitable wire. The wire should only have power when the key is in the ON position.

1. See the Wiring Diagram on the following page for these following steps. Connect the yellow and blue cables to the motor terminals on the winch. (Yellow to the positive (+) terminal of the motor. Blue to the negative (-) terminal of the motor). Tighten the terminal nuts on the motor. DO NOT over tighten. Route the other ends to the solenoid/contacter location.
2. Connect the yellow and blue cables to the solenoid/contacter (yellow to yellow and blue to blue). DO NOT tighten nuts.
3. Connect the red and black cables to the solenoid/contacter (red to red and black to black). DO NOT tighten nuts. Route the other ends to the vehicle's battery.
4. Connect the shorter red lead to the positive (+) terminal of the vehicle's 12 volt battery. Connect the other longer red lead to the solenoid/contacter. Use the supplied cable ties to attached the circuit breaker assembly where convenient.
5. Connect the rocker switch to the solenoid/contacter (black to black and green to green).
6. Splice the end of the red wire on the rocker switch, to an ignition (keyed) controlled power source using the supplied wire tap.
7. Once all wiring is connected to the solenoid/contacter it can then be mounted using the supplied M6 hardware.
8. Tighten the solenoid/contacter terminal nuts. DO NOT over tighten.
9. Connect the black lead to the negative (-) terminal of the vehicle's 12 volt battery.
10. Place all terminal boots over terminals and secure all cables with cable ties or electrical tape (not included).

11. Check for proper drum rotation. Turn the clutch knob to the "Out" position (free spooling). Pull out some cable from the drum, and then turn the clutch knob to the "In" position to engage the gears. Press the cable out button on the rocker switch. If the drum is turning and releasing more cable, then your connections are accurate. If the drum is turning and collecting more cable then reverse the leads on the motor. Repeat and check rotation.

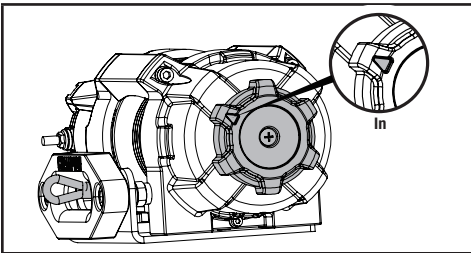
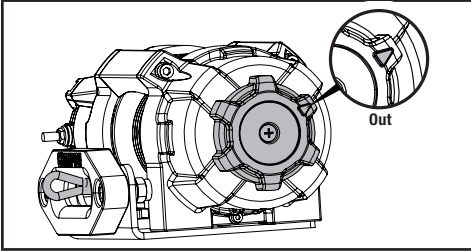

OPERATION

General Tips for Safe Operation

Your 100722 winch is rated at a 3,500 lb (1,588 kg) capacity in first layer (max) when spooling the first rope layer on the drum. Overloads can damage the winch, motor and/or synthetic rope. For loads over 1,750 lb. (794 kg) we recommend the use of the pulley block/snatch block to double the synthetic rope line. This will aid in two ways:

- reduce the number or rope layers on the drum, as well as,
- reduce the load on the rope by as much as 50%.

When doubling the line back to the vehicle, attach to the tow hook, frame or other load bearing part. The vehicle engine should be kept running during operation of the winch to minimize battery drain and maximize power and speed of the winch. If the winch is used for a considerable time with the engine off the battery may be drained and too weak to restart the motor.

Get to know your winch before you actually need to use it. We recommend that you set up a few test runs to familiarize yourself with rigging techniques, the sounds your winch makes under various loads, the way the rope spools on the drum, etc.

Inspect the synthetic rope and equipment before each use. A frayed or damaged rope shall be replaced immediately. Use only manufacturer's identical replacement rope with the exact specifications.

Inspect the winch installation and bolts to ensure that all bolts are tight before each operation. Store the remote control inside your vehicle in a place that it will not be damaged.

Any winch that appears to be damaged in any way, is found to be worn, or operates abnormally **MUST BE REMOVED FROM SERVICE UNTIL REPAIRED**. It is recommended that the necessary repairs be made by a manufacturer's authorized repair facility.

Pull only on areas of the vehicle as specified by the vehicle manufacturer. Only attachments and/or adapters supplied by the manufacturer are to be used.

Self Recovery

Locate a suitable anchor such as a strong tree trunk or boulder. Always use a sling as an anchor point.

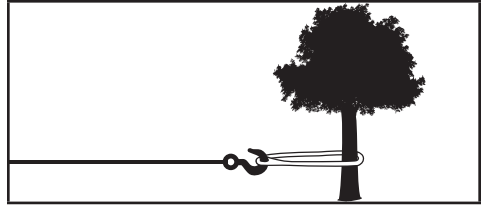

Your winch is equipped with an aluminum hawse to help guide the synthetic rope and to reduce binding on short side pulls. Do not winch from an acute angle as the synthetic rope will pile up on one side of the drum causing damage to synthetic rope and the winch.

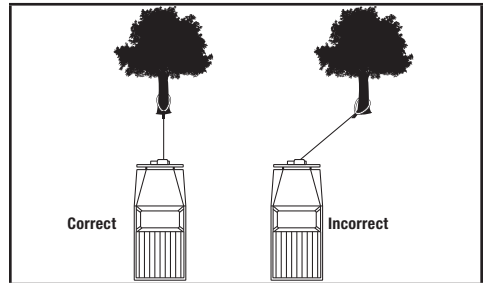

Short pulls from an angle can be used to straighten the vehicle. Long pulls should be done with the synthetic rope at a 90° angle to the winch/vehicle. When pulling a heavy load, place a blanket or jacket over the synthetic rope five or six feet from the hook.

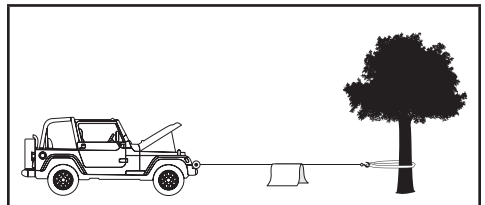

In the event of a broken cable it will dampen the snap back. For additional protection open the hood of the vehicle. For pulls over 1,750 lb. (794 kg), we recommend the use of the snatch block/pulley block to double line the synthetic rope.

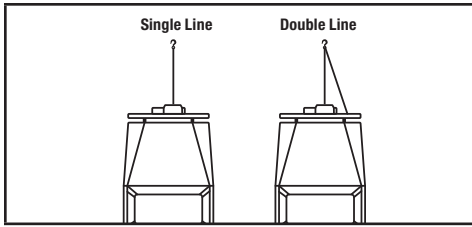

This reduces the load on the winch and the strain on the rope by approximately 50%.

Synthetic Rope Abrasion Sleeve

The winch should be set up to avoid any rough surface from contacting the rope. If that is not possible, the abrasion sleeve can be used to help protect the rope (A).

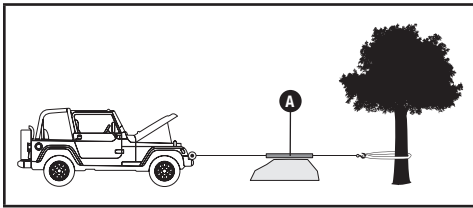

Winching Techniques A-Z

- A. Take time to assess your situation and plan your pull.
- B. Put on gloves to protect your hands.
- C. Disengage the clutch to allow free-spooling and also save battery power.
- D. Attach the hook strap to the clevis hook.
- E. Pull out the synthetic rope to your desired anchor point using the hook strap.
- F. Secure the clevis hook to the anchor point: Sling, chain or snatch block. Do not attach the hook back onto the synthetic rope.
- G. Engage the clutch.
- H. Connect the remote control to the winch. If you are going to control the winch from inside your vehicle then pass the remote through an open window to avoid the wires being pinched in the door.
- I. Start your engine to ensure power is being replenished to the battery.
- J. Drape a blanket or jacket over the synthetic rope approximately 5 to 6 feet from the hook. Open the hood for added protection.
- K. Power in the synthetic rope guiding the rope under tension to draw up the slack in the rope. Once the rope is under tension, stand clear. Never step over the synthetic rope.
- L. Double check your anchors and make sure all connections are secure.
- M. Inspect the synthetic rope. Make sure there are at least 5 wraps of synthetic rope around the winch drum.
- N. Clear the area. Make sure all spectators stand clear and that no one is directly in front or behind the vehicle or anchor point.
- O. Begin winching. Be sure that the synthetic rope is winding evenly and tightly around the drum. The vehicle that is being winched can be slowly driven to add assistance to the winching process. Avoid shock loads; keep the synthetic rope under tension.
- P. The vehicle to be winched should be placed in neutral and the emergency brake released. Only release the brake pedal when under full tension. Avoid shock loads to the winch. This can damage the winch, rope and vehicle.
- Q. The winch is meant for intermittent use. Under full load with a single line rig do not power in for more than a minute without letting the motor cool down for a few minutes and then resume the winching operation.
- R. The winching operation is complete once the vehicle is on stable ground and is able to drive under its own power.
- S. Secure the vehicle. Be sure to set the brakes and place the vehicle in park.
- T. Release the tension on the synthetic rope. The winch is not meant to hold the vehicle for long periods of time.
- U. Disconnect the synthetic rope from the anchor.
- V. Rewind the synthetic rope. Make sure that any rope already on the drum has spooled tightly and neatly. If not, draw out the rope and re-spool from the point where the rope is tight.

- W. Keep your hands clear of the winch drum and hawse as the synthetic rope is being drawn in.
 - X. Secure the hook and hook strap.
 - Y. Disconnect the remote control and store in a clean, dry place.
 - Z. Clean and inspect connections and mounting hardware for next winching operation.
- 4. Retract Synthetic Rope onto drum being careful not to allow kinking.

Synthetic Rope

Periodically rinse the synthetic rope with water to remove any sand, dirt, mud, or debris that can become embedded or build up in the rope during use. This will help extend the life of the rope.

MAINTENANCE

The owner/operator is responsible for all periodic maintenance.

WARNING

Never operate a damaged or defective winch.

WARNING

Improper maintenance will void your warranty.

Complete all scheduled maintenance in a timely manner. Correct any issue before operating the winch.

NOTICE

For service or parts assistance, contact our help line at 1-877-338-0999

Lubrication

All moving parts within the Electric Winch having been Lubricated using high temperature lithium grease at the factory. No internal lubrication is required. Lubricate Cable Assembly periodically using a light penetrating oil.

Synthetic Rope Replacement

It is recommended that any modifications be performed by a manufacturer's authorized repair facility, and that only manufacturer-supplied parts be used.

1. Move the clutch to the "Out" position.
2. Extend Synthetic Rope to its full length. Note how the existing rope is connected to the inside of the drum.
3. Remove old Synthetic Rope and attach new one.

NOTICE

Inspect rope before and after each use. If rope becomes frayed it must be replaced.

SPECIFICATIONS

Performance Specifications

Winch Model	100722	Gross Weight	27.3 lb. (12.4 kg)
Rated Pull	3,500 lb (1,588 kg)	Net Weight	24 lb. (10.9 kg)
Gear Reduction Ratio	180:1	Height	5 in. (12.6 cm)
Motor	Permanent Magnet	Width	4.8 in. (12.1 cm)
.....	1.2 HP (0.9 kW) (12V DC)	Length	13.8 in. (35 cm)
Duty Cycle	Intermittent	Bolt Pattern	4.9 in. × 3 in. (12.4 cm × 7.6 cm)
Drum Size	1.7 in. (D) × 3.2 in. (L)	IP Rating	IP68 Water and Dust Proofing Rated
.....	[44.5 mm(D) × 81 mm(L)]		
Synthetic Rope	3/16 in. (D) × 50 ft. (L)		
.....	[4.8 mm(D) × 15.2 m(L)]		

Line Speed and Motor Current (First Layer)

Line Pull	LB	0	1000	2000	2500	3500
	KG	0	454	907	1134	1588
Line Speed (12V DC)	FPM	12.1	10.8	8.2	7.5	4.9
	MPM	3.7	3.3	2.5	2.3	1.5
Motor Current (12V DC)	A	28	60	90	105	130
Running Time*	Minutes	5	5	5	5	5
Cooling Time**	Minutes	5	5	5	5	5

*If the motor becomes uncomfortably hot to the touch, stop winching immediately and let it cool down for 5 minutes. Do not pull for more than one minute at or near the rated load.

**Electric winches are designed and made for intermittent use and should not be used in constant duty applications.

Line Pull and Cable Capacity Per Layer

Line of Cable		1	2	3	4	5
Rated Line Pull	LB	3500	2927	2517	2207	1966
	KG	1588	1329	1143	1002	892
Cable Capacity	FT	7.6	16.7	27.3	39.4	50
	M	2.3	5.0	8.3	12.0	15.2

It is recommended to use double line and snatch block for pulling loads over 1,750 lb. (794 kg).

TROUBLESHOOTING

Problem	Cause	Solution
Motor does not turn on	Loose battery cable connections	Tighten nuts on all cable connections
	Defective Switch Assembly	Replace Switch Assembly
	Defective motor	Check for voltage at armature port with Switch pressed. If voltage is present, Replace motor
	Water has entered motor	Check for voltage at armature port with Switch pressed. If voltage is present, Replace motor
Motor runs but Cable drum does not turn	Clutch not engaged	Move Clutch to the "In" position. If problem persists, a qualified technician needs to check and repair.
Motor runs slowly or without normal power	Insufficient current or voltage	The battery is weak, recharge. Run winch with vehicle motor running (Battery should have a strong charge)
	Loose or corroded battery cable connections.	Clean, Tighten, or replace
Motor overheating	Winch running time too long	Allow winch to cool down periodically
Motor runs in one direction only	Defective Switch Assembly	Replace Switch Assembly

For further technical support:

Technical Support Team

Toll Free 1-877-338-0999

support@championpowerequipment.com

WARRANTY*

CHAMPION POWER EQUIPMENT
2 YEAR LIMITED WARRANTY

Warranty Qualifications

To register your product for warranty and FREE lifetime call center technical support please visit:

<https://www.championpowerequipment.com/register>

To complete registration you will need to include a copy of the purchase receipt as proof of original purchase. Proof of purchase is required for warranty service. Please register within ten (10) days from date of purchase.

Repair/Replacement Warranty

CPE warrants to the original purchaser that the mechanical and electrical components will be free of defects in material and workmanship for a period of two years (parts and labor) from the original date of purchase and 180 days (parts and labor) for commercial and industrial use. Transportation charges on product submitted for repair or replacement under this warranty are the sole responsibility of the purchaser. This warranty only applies to the original purchaser and is not transferable.

Do Not Return The Unit To The Place Of Purchase

Contact CPE's Technical Service and CPE will troubleshoot any issue via phone or e-mail. If the problem is not corrected by this method, CPE may, at its option, authorize other means of repair and/or replacement.

Warranty Exclusions

This warranty does not cover the following repairs and equipment:

Normal Wear

Products with mechanical and electrical components need periodic parts and service to perform well. This warranty does not cover repair when normal use has exhausted the life of a part or the equipment as a whole.

Installation, Use and Maintenance

This warranty will not apply to parts and/or labor if the product is deemed to have been misused, neglected, involved in an accident, abused, loaded beyond the product's limits, modified, installed improperly or connected incorrectly to any electrical component. Normal maintenance is not covered by this warranty and is not required to be performed at a facility or by a person authorized by CPE.

Other Exclusions

This warranty excludes:

- Cosmetic defects such as paint, decals, etc.
- Wear items such as winch cable, etc.
- Accessory parts such as storage covers.
- Failures due to acts of God and other force majeure events beyond the manufacturer's control.
- Problems caused by parts that are not original Champion Power Equipment parts.

Limits of Implied Warranty and Consequential Damage

Champion Power Equipment disclaims any obligation to cover any loss of time, use of this product, freight, or any incidental or consequential claim by anyone from using this product. THIS WARRANTY IS IN LIEU OF ALL OTHER WARRANTIES, EXPRESS OR IMPLIED, INCLUDING WARRANTIES OF MERCHANTABILITY OR FITNESS FOR A PARTICULAR PURPOSE.

A unit provided as an exchange will be subject to the warranty of the original unit. The length of the warranty governing the exchanged unit will remain calculated by reference to the purchase date of the original unit.

This warranty gives you certain legal rights which may change from state to state or province to province. Your state or province may also have other rights you may be entitled to that are not listed within this warranty.

Contact Information

Address

Champion Power Equipment, Inc.
12039 Smith Ave.
Santa Fe Springs, CA 90670 USA
www.championpowerequipment.com

Customer Service

Toll Free: 1-877-338-0999
info@championpowerequipment.com
Fax no.: 1-562-236-9429

Technical Service

Toll Free: 1-877-338-0999
tech@championpowerequipment.com

📞 EMERGENCY 24 HOUR SUPPORT: 1-562-204-1188