

FRASER HILL FARM[®]

Thank you for your purchase!

With proper use and care, this product will provide you with years of enjoyment. If you have any questions, please contact us directly.

✉ **Holiday@FraserHillFarm.com** (Anytime)

☎ **855-591-7451**

(9AM to 9PM Eastern Time, Monday - Friday)

(9AM to 5PM Saturday - Sunday)

In the unlikely event that you experience a problem, please provide pictures and a description of the problem, a receipt (if available), name and address of the purchaser and the name of retailer where you purchased the product.

Please do not return this item to the retailer.

Please call our toll-free number 1 (855) 591-7451 or email us at Holiday@FraserHillFarm.com and a customer service representative will assist you.

ENJOY YOUR HOLIDAY!

FFRS048-NC5-RD 48"H LED Lit Moving Train Nutcracker in Red Crown w/Music

IMPORTANT SAFETY INSTRUCTIONS READ AND FOLLOW ALL SAFETY INSTRUCTIONS

FOR INDOOR or OUTDOOR USE

- The product and its adapter are intended for indoor or outdoor use. When product is used in outdoor applications, connect the adapter to a Ground Fault Circuit Interrupter (GFCI) outlet available at your hardware store. If you desire a more permanent solution, please contact a qualified electrician for proper installation. This seasonal use product is not intended for permanent year-round installation of FFRS048-NC5-RD use.
- Do not mount or place near gas or electric heaters, fireplaces, candles or other similar sources of heat.
- Do not secure the wiring of the product with staples or nails, or place on sharp hooks or nails.
- Unplug the product when leaving the house, when retiring for the night, or if left unattended.
- **CAUTION:** This is an electrical product – not a toy! To avoid risk of fire, burns, personal injury and electric shock, it should not be played with or placed where small children can reach it.
- Keep this product well ventilated. Do not cover product with cloth, paper, or any material not part of the product when in use.
- Do not use with a voltage converter. Use only with adapter plug provided.
- Do not use this product for other than its intended use.
- Do not hang ornaments or other objects from cord, wire, or light string.
- Do not close doors or windows on the products or extension cords as this may damage the wire insulation.
- Never operate this product if the power cord or plug is damaged.
- In case the external flexible cable or cord of the adapter is damaged:
DO NOT USE THAT DAMAGED ADAPTOR, DO NOT OPEN TO REWIRE! THROW ADAPTOR AWAY.
- Use of product in extreme weather conditions if not recommended.

BEFORE YOUR START

- Check the carton and make sure you have all parts as listed below:
-Resin Product -Adapter & Cord -Detachable Music Box -Detachable Small Bear

IMPORTANT: Do not dispose of the foam mold and carton before you complete the assembly. Detachable parts and adapter may be sitting there. Keep the package material for storage purpose.

CARE AND MAINTENANCE

- Before using or reusing, inspect product carefully. Discard any product that has cut, damaged or frayed wire insulation or cords, or exposed copper wire.
- When not in use, store neatly in a cool, dry location protected from sunlight.

Note: This nutcracker is hand painted and has moving train, LED lights, and Music and the product is constructed with non-replaceable light bulbs.

IMPORTANT SAFETY INSTRUCTIONS

When using electrical products, be sure to always follow these basic precautions:

1. Read and follow all instructions and safety instructions before opening product.
2. Do not use an extension cord.
3. Refer to the National Electrical Code, ANS/NFPA 70, for the installation of wiring and clearances from power and lighting conductors.
4. Do not install or use within 10 feet of water source (pool, bathtub, sink, etc.)
5. Warning: Risk of Electric Shock, Mount higher than one foot from the ground surface.

WHATS INCLUDED IN THE CARTON:

- a. Nutcracker
- b. Music w/ Train
- c. Bear Topper for Music Box
- d. Adapter – UL Listed

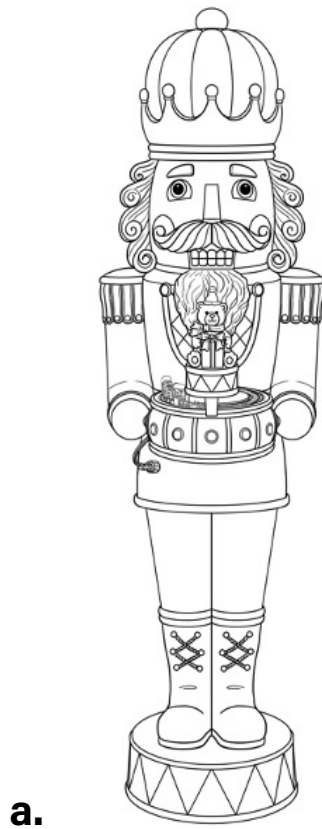

ASSEMBLY INSTRUCTIONS

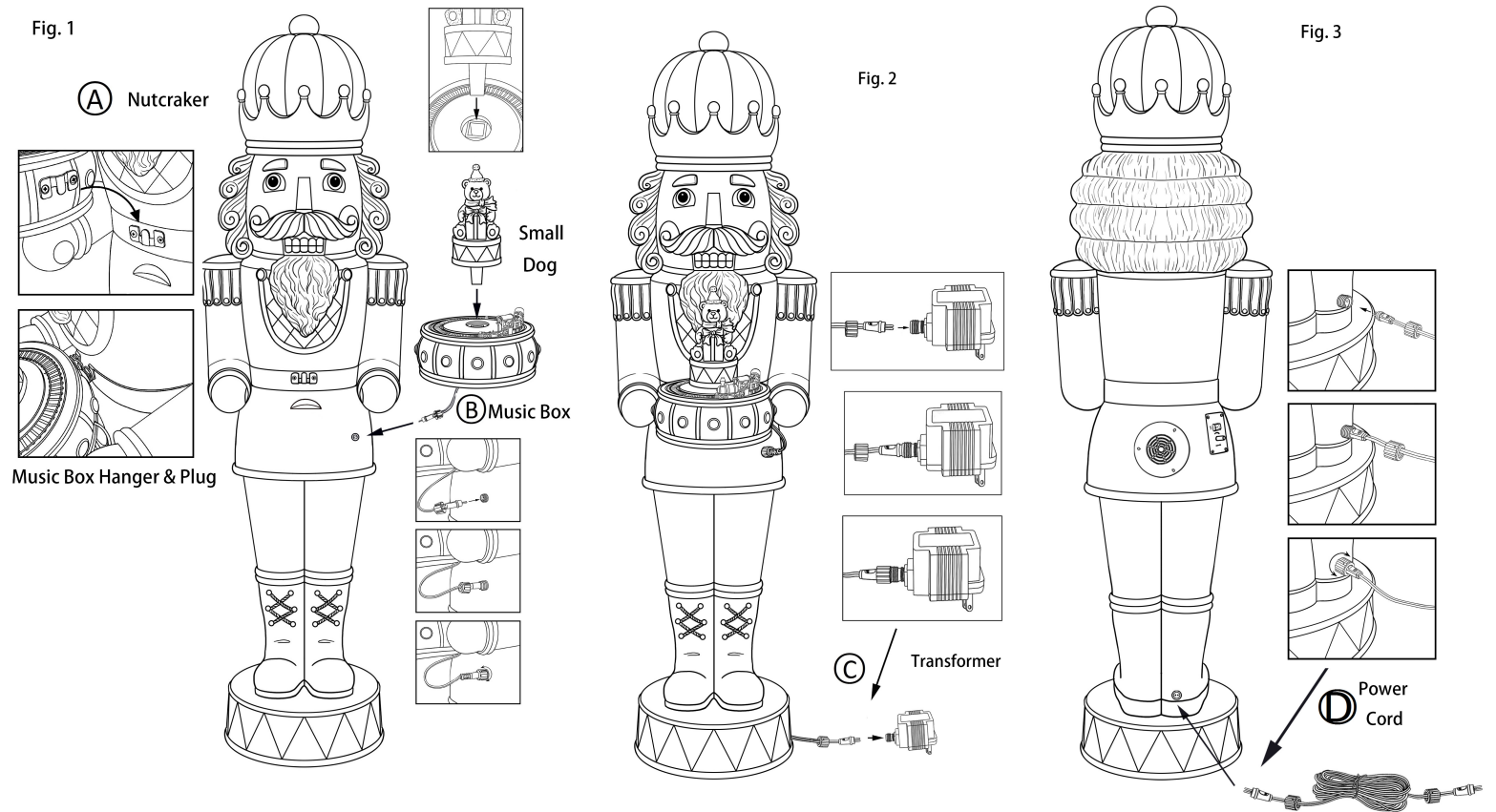

Drum Assembly:

STEP 1: Using 2 people, gently lift the unit from the packaging. **DO NOT LIFT BY NUTCRACKER ARMS.** Place the nutcracker on a flat surface.

STEP 2: Gently lift the music box unit from packaging. Mount the metal hook music box unit to the other hook on the waist of Nutcracker. Attach the plug of cord on music box unit to connector on Nutcracker, and twist the cap to secure tightly in right position. **See Fig. 1.**

Christmas Tree Assembly:

STEP 1: Take the Small Bear from packaging and place it onto music box.

STEP 2: Place the small bear into the hole on music box.

See Fig. 1 and below Illustration.

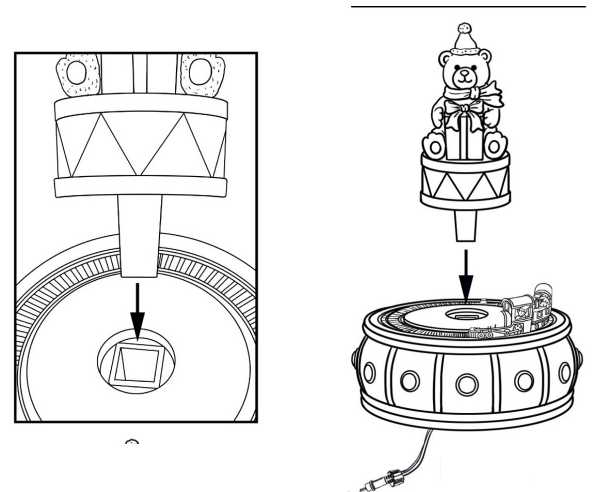

Nutcracker Operation:

1. Remove the protective cap and connect the prong ends into the cord plug at the back of the base of nutcracker. Twist cap attached to the cord onto the plug on the base and secure it.

See Fig. 3 and Fig. 4

2. Assembly of cord is required prior to plugging in to a nearby working outlet. Connect the 2 prong ends to adapter. Twist the cap and secure cord to adapter tightly.

Now nutcracker is ready to plug in and operate. **(See Below)**

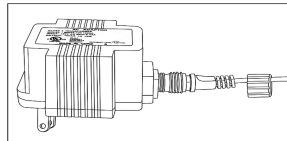
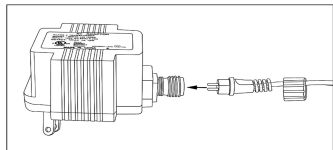

(See Fig. 3 and Right Sketch)

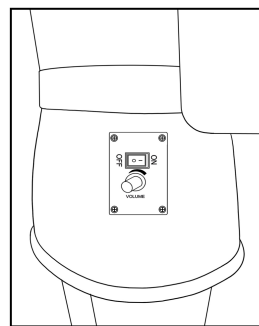
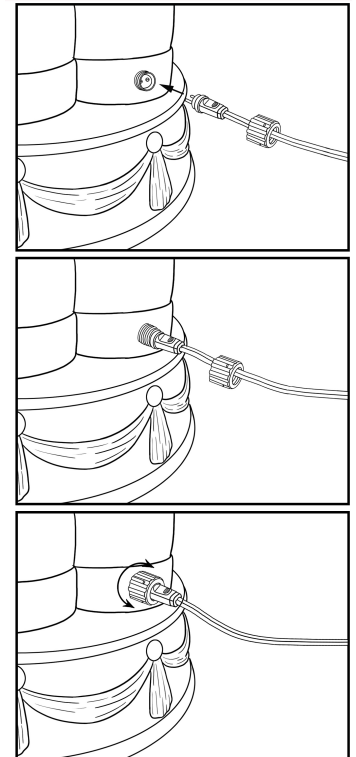
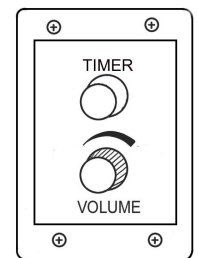

Fig. 4



TIMER: A timer is built into the movement mechanism. Turning the “VOLUME” switch to ON position will turn on the lights, activate drumming movement, and begin music playing. Lights, hand movement, and music including eight holiday songs will work in a loop of 6 hours after pressing “TIMER” button until power is turned off. Please press “TIMER” button again to replay after 6 hours when the “VOLUME” switch still in alert status.



TROUBLESHOOTING

If the product's LED lights/movement/musical does not work:

1. Make sure the transformer is connected to a power supply.
2. Make sure the product is properly connected to the transformer.
 - o Do not force positions of hands – components must be aligned properly.
 - o Do not block movement of hands.

CAUTION:

This is not a toy. Disconnect the plug when the unit is not under the supervision of an adult.

Specification of Adaptor:

Adaptor used: Input Voltage: 120V AC 60Hz 0.25A

Output Voltage: 12V 1A Efficiency Level: IV 115V

SAVE THESE INSTRUCTIONS!

1-YEAR LIMITED WARRANTY

“Limited” Warranty Program

For a period of one (1) year after purchase, Fraser Hill Farm (“Manufacturer”) will either repair or replace defective components in accordance with this Limited Warranty.

Sales and use taxes, plus shipping and handling charges are the responsibility of the consumer.

This warranty is between Manufacturer and the original purchaser and is valid only when accompanied by the original purchaser’s sales receipt showing original date of purchase and location of purchase. Replacements under this warranty revert back to the date of original purchase for future warranty.

Manufacturer or its authorized dealer can accept or reject warranty claims based on its findings. This warranty applies in normal residential use only, where an issue with the product is due to a defect in material or workmanship. Manufacturer can make substitutions as required of materials, components, and sub-components of comparable value and utility. This warranty is limited to product repair or replacement (to be determined solely by Manufacturer). Warranty return is limited to only the single affected component.

This warranty covers only manufacturing defects and does not cover normal wear and tear, abuse or misuse, including: water damage, chemical damage, exposure to extreme heat or cold, abrasion or excessive weight. This product is intended to be used with standard ornaments only. This warranty is invalid if the product is not used for intended purpose. Manufacturer disclaims liability for any aspect of installation and any inconvenience caused by a defective part or component.

Certain items are not covered by this warranty. These include, but are not limited to the following:

1. Components subjected to abuse, including abuse intended to simulate failure.
2. Damages caused by retailer, shipper or installation crew (such as scratches, dents, tears, etc.).
3. Any part which merely exhibits normal wear yet functions essentially as new, including stretching of materials and stitching.
4. Tears, punctures, scratches or any damage caused by improper installation or use.
5. Items sold “as is” or floor models.

To make a claim, send a copy of the original sales receipt along with a brief description of the problem to the email address below. Please include your email address and daytime telephone or cell phone #. All items maybe charged actual freight and handling costs. Repairs or replacement will be made at the Manufacturer’s option.

THIS IS THE ENTIRE EXCLUSIVE EXPRESS LIMITED LIABILITY. THE MANUFACTURER NEITHER MAKES NOR IS RESPONSIBLE FOR ANY OTHER WARRANTIES, EITHER EXPRESS OR IMPLIED, INCLUDING THOSE OF RETAILING DEALERS. THIS EXCLUSIVE REMEDY IS LIMITED TO RECEIPT OF A CREDIT IN CONNECTION WITH THE REPAIR OR REPLACEMENT OF ANY PRODUCT OR COMPONENT DEEMED TO BE DEFECTIVE UNDER THE TERMS AND CONDITIONS AS STATED IN THIS WARRANTY. NEITHER FRASER HILL FARM, THE PRODUCT MANUFACTURER NOR ITS AGENTS SHALL BE LIABLE IN ANY CASE FOR INCIDENTAL, INDIRECT, SPECIAL OR CONSEQUENTIAL DAMAGES RESULTING FROM THE USE OF THIS PRODUCT OR ARISING OUT OF ANY BREACH OF THIS WARRANTY OR NEGLIGENCE EVEN IF IT HAS BEEN ADVISED OF THE POSSIBILITY OF SUCH DAMAGES. EXCEPT AS OTHERWISE MAY BE REQUIRED BY LAW, THERE ARE NO OTHER EXPRESS OR IMPLIED WARRANTIES OTHER THAN THE WARRANTY DESCRIBED HEREIN, AND ALL OTHER WARRANTIES, INCLUDING ANY IMPLIED WARRANTY OF MERCHANTABILITY OR FITNESS FOR A PARTICULAR PURPOSE ARE EXPRESSLY DISCLAIMED.

Holiday@FraserHillFarm.com