

BUNGALOW COOP Assembly Manual

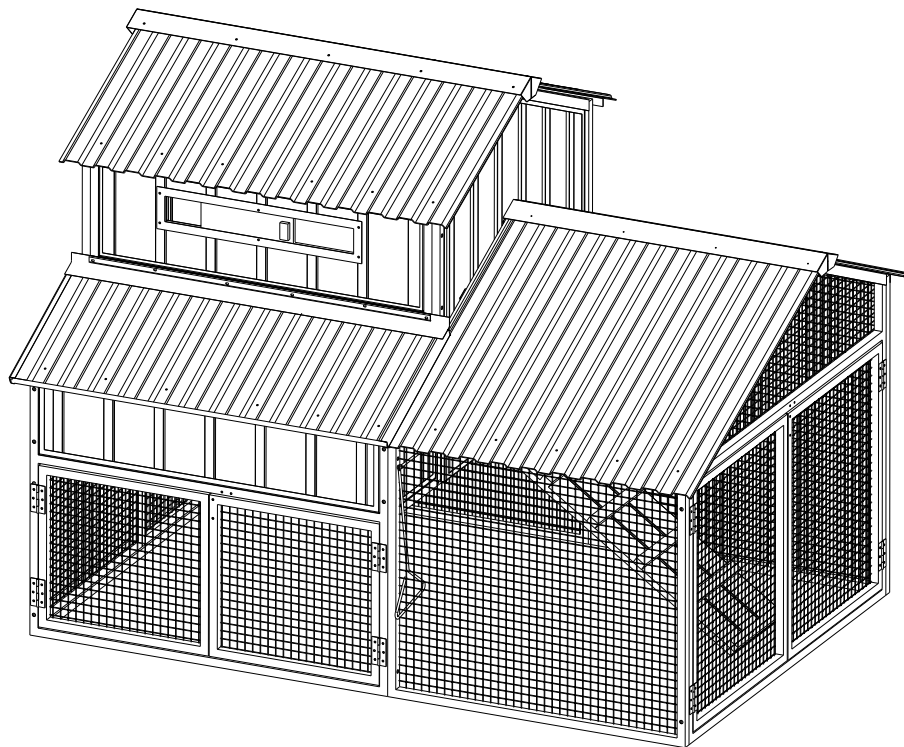

SKU# 2432292/2448045/2448046



Tools required for assembly (not included)

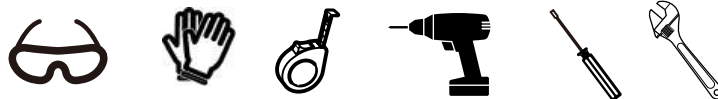





Distributed by: TRACTOR SUPPLY COMPANY
5401 VIRGINIA WAY, BRENTWOOD, TN 37027
For customer support, call: 1-888-376-9601

www.TractorSupply.com

MADE IN CHINA

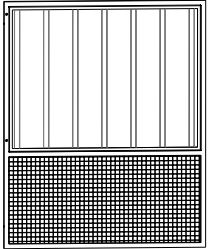
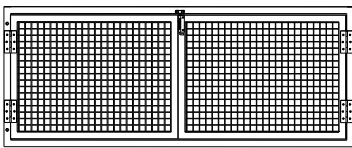
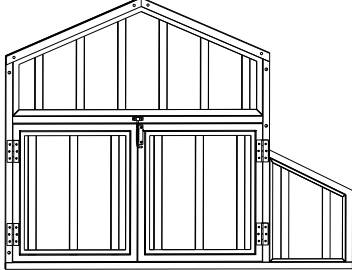
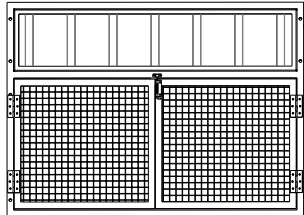
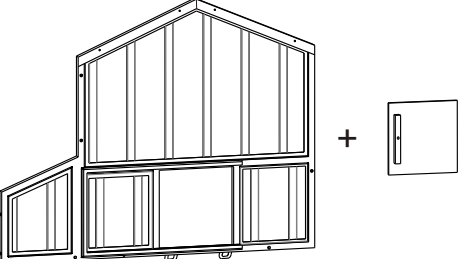
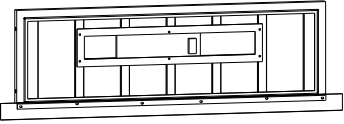

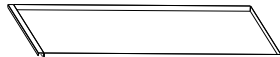



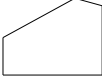

PARTS LIST

Please check the parts and quantities before assembly

Part#	Description	Drawing	Qty.
1	Coop Right Panel		1
2	Run Back Panel		1
3	Coop Back Panel		1
4	Nesting Box Front Panel		1
5	Coop Front Panel		1
6	Coop Left Panel		1
7	Tray Support Bar		4
8	Tray		1
9	Nesting Box Floor		1

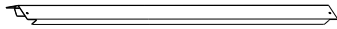
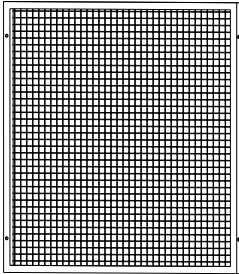
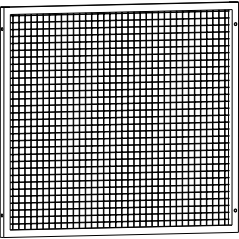
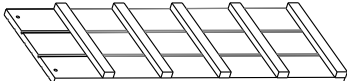
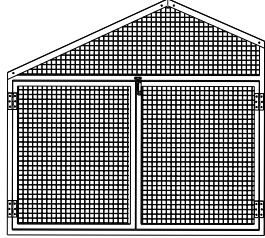

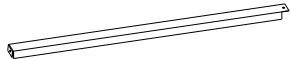





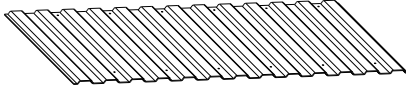
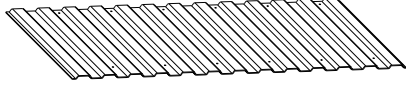
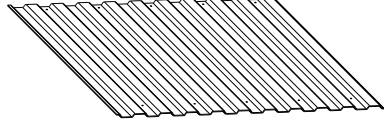
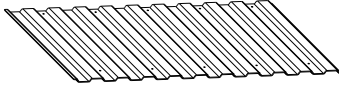
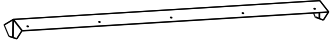
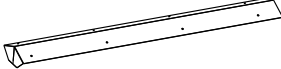
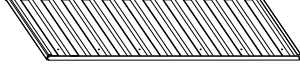

PARTS LIST

Please check the parts and quantities before assembly

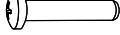
Part#	Description	Drawing	Qty.
10	Nesting Box Divider		2
11	Short Roosting Bar		2
12	Long Roosting Bar		1
13	Coop Roof Shoulder Support		2
14	Coop Roof Peak Support		1
15	Pen Right Mesh Panel		1
16	Pen Left Mesh Panel		1
17	Ramp		1
18	Pen Front Panel		1
19	Pen Roof Shoulder Support 1		2
20	Pen Roof Shoulder Support 2		1
21	Pen Roof Peak Support		1

PARTS LIST

Please check the parts and quantities before assembly

Part#	Description	Drawing	Qty.
22	Coop PVC Roof -Bigger Side		1
23	Coop PVC Roof -Smaller Side		1
24	Pen PVC Roof-Bigger Side		1
25	Pen PVC Roof-Smaller Side		1
26	Coop Roof Top Cap		1
27	Pen Roof Top Cap		1
28	Nesting Box Roof		1
29	Access Door Handle		1
30	Roosting Bar Holder		6
31	Ramp Hook		2
32	M6x35 Bolt		32+2
33	M6x25 Bolt		2
34	M4x20 Bolt		1
35	Self-tapping Screw 4.8x13mm		75+2
36	Self-tapping Screw with Washer 4x10mm		33+2
37	M6 Lock Nut		2

ASSEMBLY

Get Ready:

- Follow Diagram 1, attach 2pcs of #30 (Roosting Bar Holder) to the wood board side of Panel #1 (Coop Right Panel), using the pre-drilled holes.
- Repeat above step, installing one #30 at the designated positions of #3 (Coop Back Panel) and #5 (Coop Front Panel) respectively, and installing two #30s on #6 (Coop Left Panel). Please refer to below Figures (2), (3), and (4).

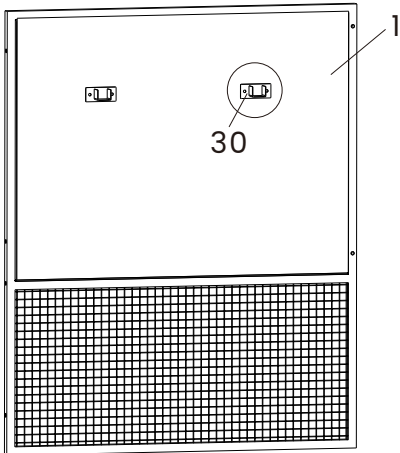

(1)

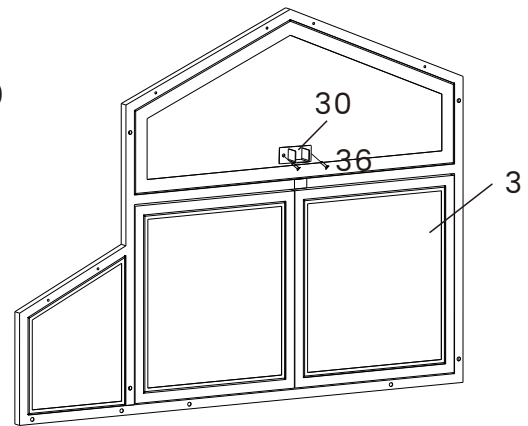
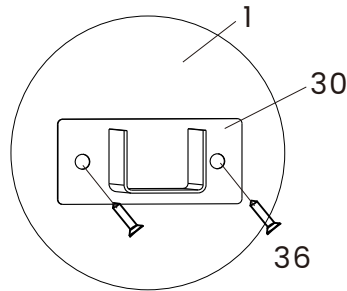

(2)

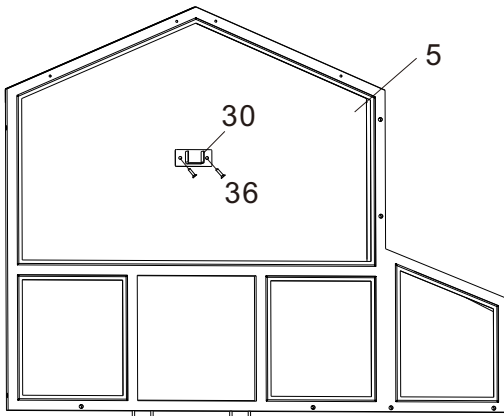

(3)

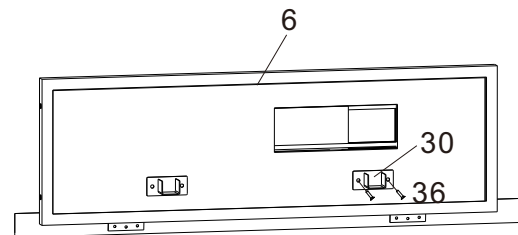

(4)

- Place the sliding door on Panel #5 as shown in the below diagram, paying attention to the direction of the sliding door.

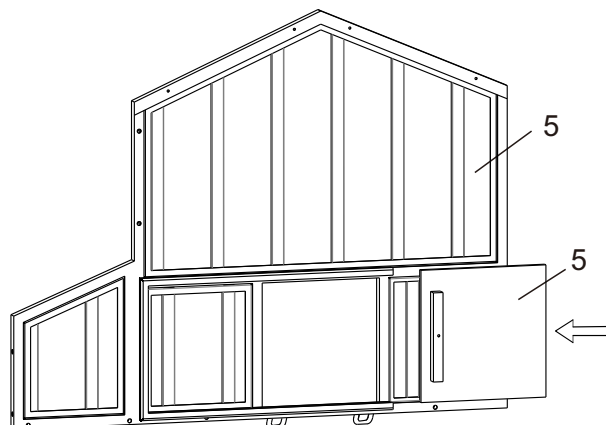

ASSEMBLY

Step 1

- Assemble Panels #1, #2, #3, and #4 firmly using Bolts #32. Panel #3 should be directly above Panel #2.

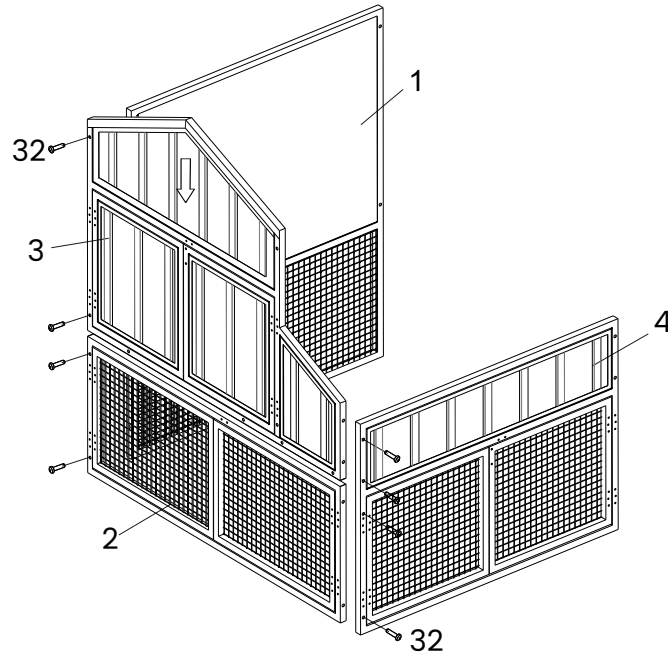

Step 2

- Securely install Panel #5 as below diagram using 4 pieces of Bolt #32.

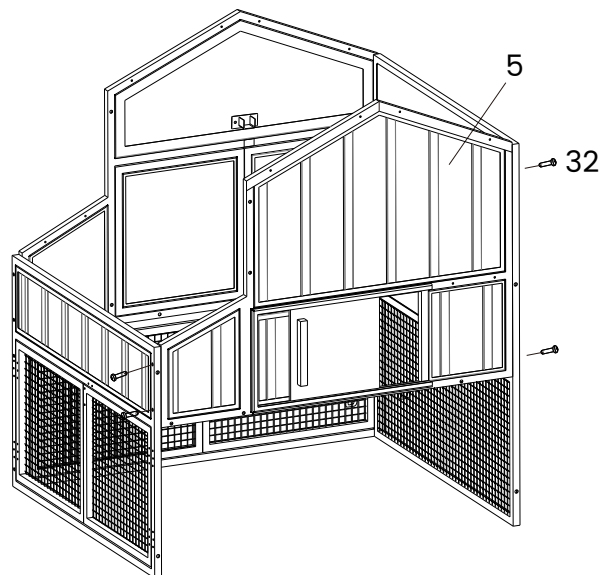

ASSEMBLY

Step 3

- Attach Panel #6 using 4 pieces of #32.

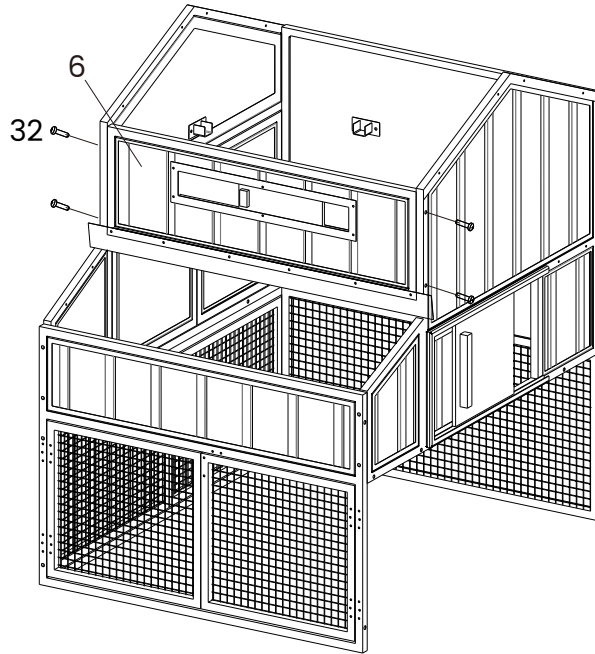

Step 4

- Install the 4 pieces of #7 (Tray Support Bar) to the illustrated positions using Bolts #32.

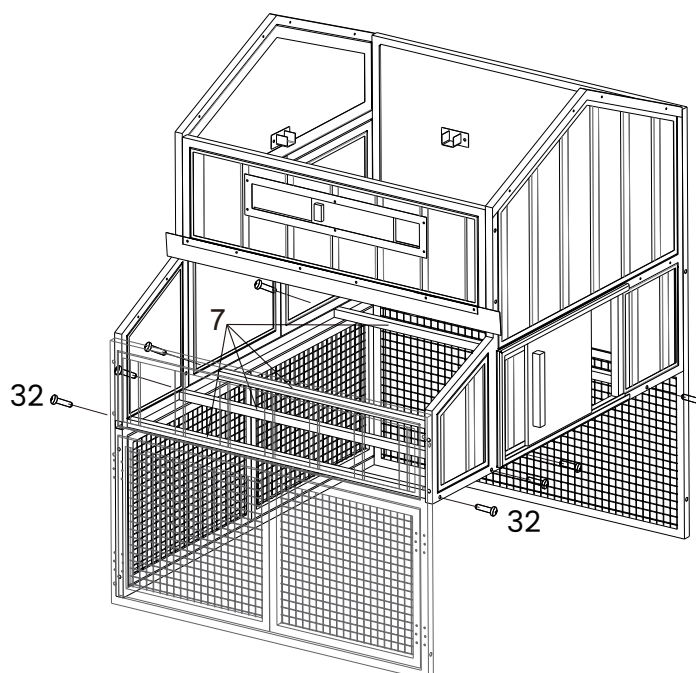

Step 5

- Open the door of Panel #3, and push #8 (Tray) from the doorway into the chicken coop.
- Place #9 (Nesting Box Floor) and #10 (Divider) in the Nesting Box as shown in the diagram.
- Place The Roosting Bars (#11 and #12) on the pre-fixed Roosting Bar Holders as below diagram.

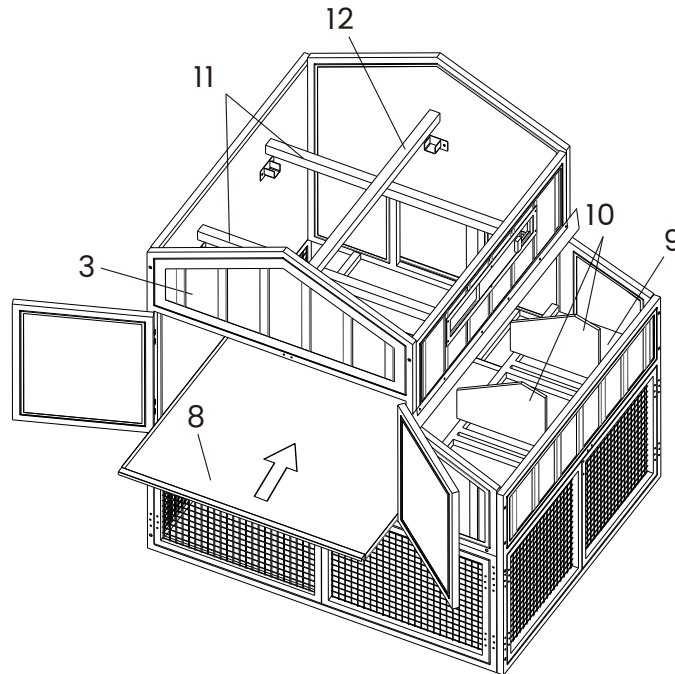

Step 6

- Install 2 pieces of #13 (Roof Shoulder Support) and 1 piece of #14 (Roof Peak Support) using Self-Tapping Screws #35 through the pre-drilled holes respectively.

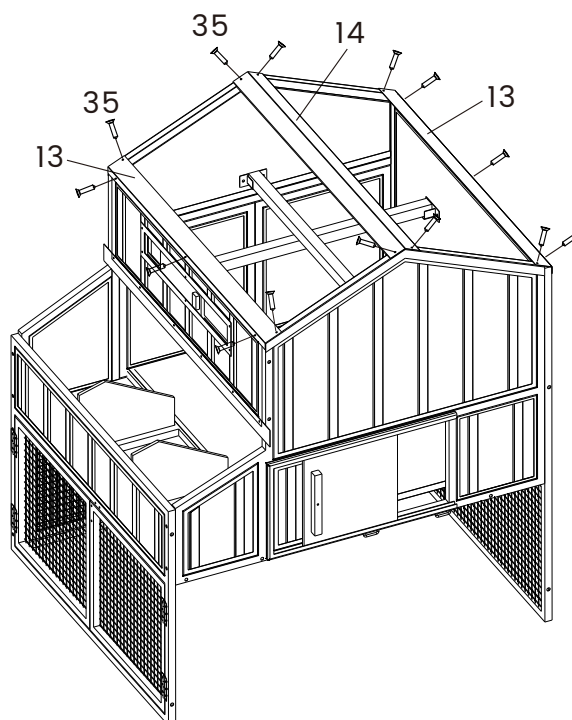

Step 7

- Install #15 (Pen Right Panel) onto Panel #1 using 2 Pieces Bolt #32, and same way, install #16 (Pen Left Panel) onto Panel #4 using Bolt #32.

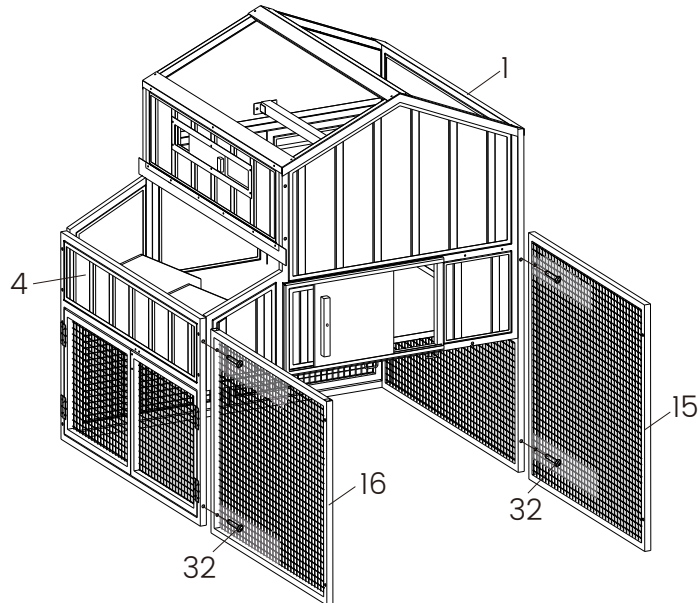

Step 8

- First, install 2pcs of #31 (Ramp Hook) onto #17 (The Ramp) using Bolts #33 and Nuts #37, then hang the assembled unit onto the hook at the bottom of Panel #5.
- Insert one end of #29 (Access Door Handle) through the mesh of #16, then secure it to the sliding door on Panel #5 using Bolt #34.

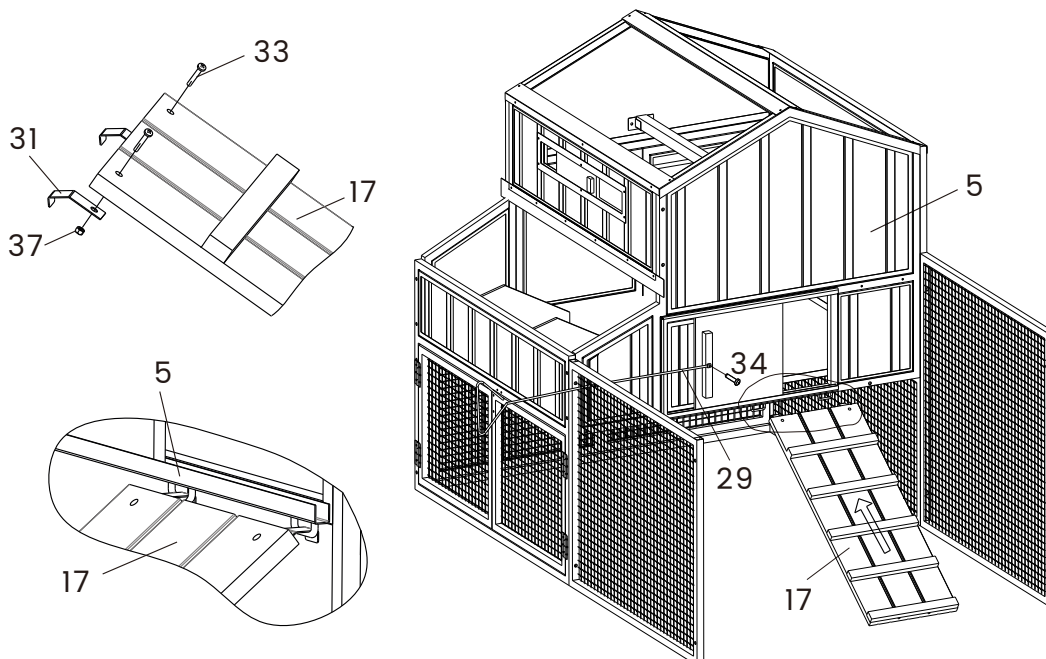

ASSEMBLY

Step 9

- Securely install #18 (Pen Front Panel) using 4 pieces of Bolts #32.

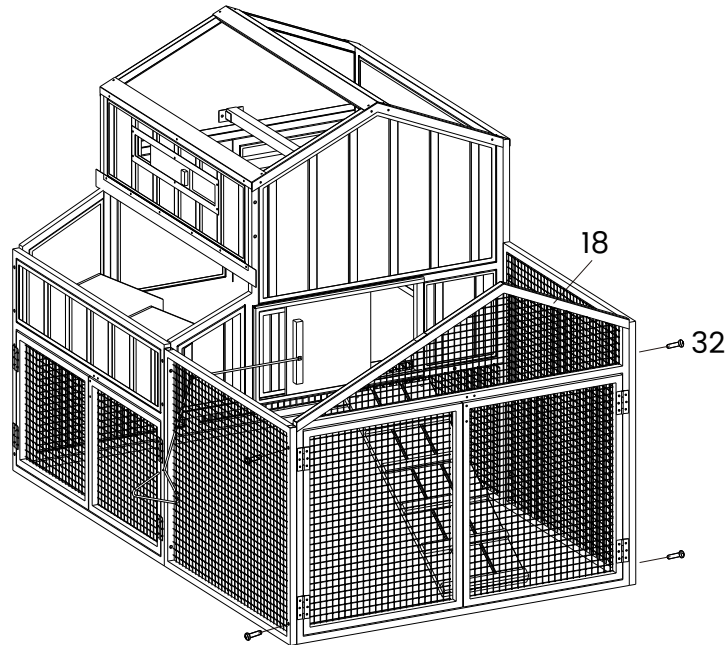

Step 10

- Install 2 pieces of #19 (Pen Roof Shoulder Support 1), 1 piece of #20 (Pen Roof Shoulder Support 2) and 1 piece of #21 (Pen Roof Peak Support) using Screws #35 & #36.

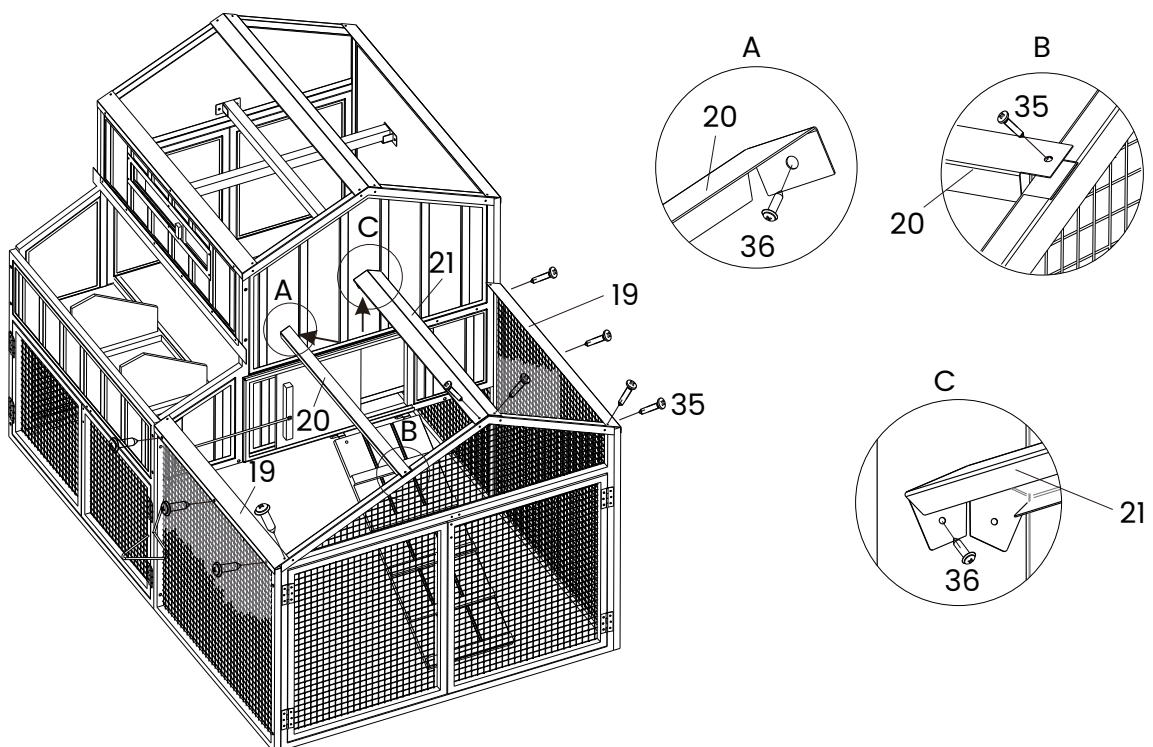

Step 11

- Arrange the four roof panels #22, #23, #24, #25 as shown in the diagram, and securely install them, one by one, using Screws #35 through the pre-drilled holes.

Note: #22 and #23 should be placed centered.

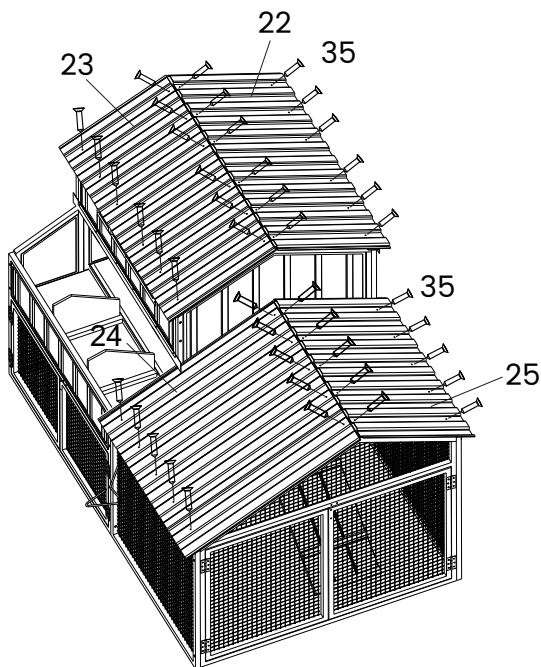

Step 12

- Install Roof Caps #26 and #27 onto the top of the roof using #36 through the pre-drilled holes.

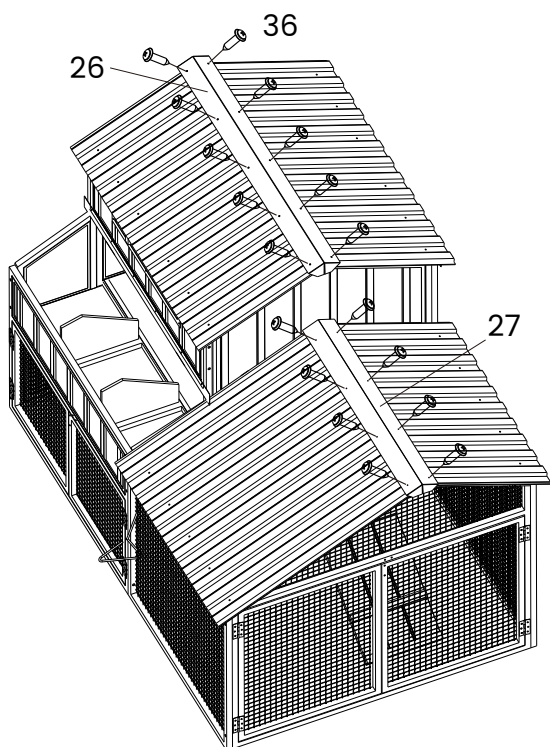

Step 13

- Lift the Rain Guard of Panel #6, then place #28 (Nesting Box Roof Panel) centered from left to right, and secure it firmly with #35 as shown in the diagram.

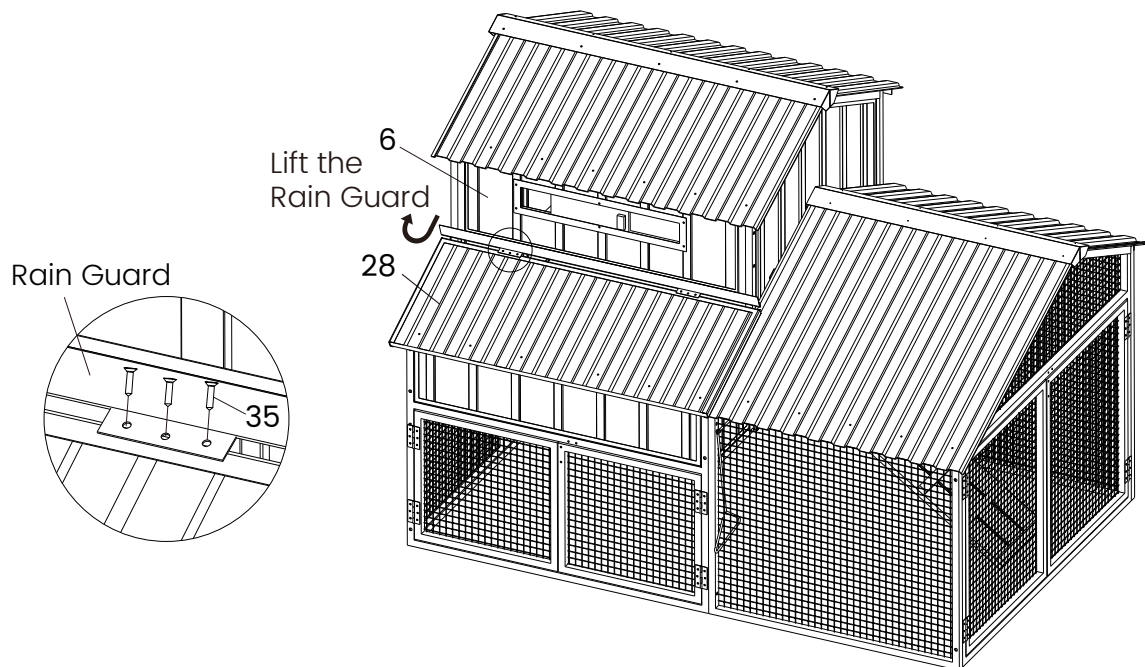

The entire assembly is now completed