



**REBEL RED CANISTER VACUUM
OWNER'S MANUAL**

Model: RBR2CV

120V, 1400W



Atrix

1350 Larc Industrial Blvd.

Burnsville, MN 55337

www.atrix.com

sales@atrix.com

Telephone: 952.894.6154

Toll Free Telephone: 800.222.6154

Fax: 952.894.6256

IMPORTANT SAFETY INSTRUCTIONS

When using an electrical appliance, basic precautions should always be followed, including the following:

READ ALL INSTRUCTIONS BEFORE USING APPLIANCE

WARNING:

TO REDUCE THE RISK OF FIRE, ELECTRICAL SHOCK OR INJURY:

1. Do not leave appliance when plugged in. Unplug from outlet when not in use and before servicing.
2. Electrical shock may occur if used outdoors or on wet surfaces.
3. Do not allow vacuum to be used as a toy. Pay close attention when vacuum is used by or near children.
4. Use only as described in this manual. Use only manufacturer's recommended instructions.
5. Do not use with damaged cord or plug. If appliance is not working as it should, has been dropped, damaged, left outdoors, or dropped into water, return it to Atrix International to be evaluated (refer to warranty policy).
6. Do not pull or carry by cord, use cord as a handle, close a door on cord, or pull cord around sharp edges of corners. Do not run appliance over cord. Keep cord away from heated surfaces.
7. Do not unplug by pulling on cord. To unplug, grasp plug, not the cord.
8. Do not handle plug or appliance with wet hands.
9. Do not put any object into openings. Do not use with any opening blocked; keep free of dust, lint, hair, and anything that may reduce airflow.

10. Keep hair, loose clothing, fingers and all body parts away from openings and moving parts.
11. Do not pick up anything that is burning or smoking such as cigarettes, matches or hot ashes.
12. Do not use without filter in place.
13. Turn off all controls before unplugging.
14. Use extra care when cleaning on stairs.
15. Do not use to pick up any liquids, including flammable or combustible liquids such as gasoline or use in areas where they may be present.
16. Connect to a properly grounded outlet only.
17. This appliance is not intended for use by persons (including children) with reduced physical, sensory or mental capabilities, or lack of experience and knowledge, unless they have been given supervision or instruction concerning use of the appliance by a person responsible for their safety.
18. Children should be supervised to ensure that they do not play with the vacuum.

SAVE THESE INTRUCTIONS!



Components and Equipment

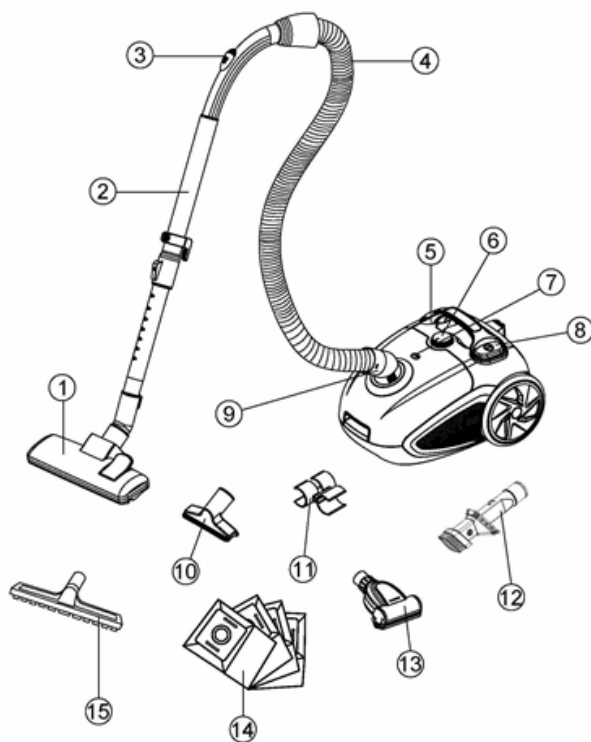

1. Floor Brush (*AHC-57*)
2. Telescopic Extension Wand (*AHC61-63*)
3. Air Slide Suction Control
4. Hose (*AHC-65*)
5. Automatic Cord Rewind Button
6. Suction Control Regulator/Power Adjustment
7. Full Bag Indicator
8. On/Off Power Button
9. Suction Hose Connection
10. Upholstery Nozzle (*AHC-59*)
11. Accessory Holder (*AHC-64*)
12. 3-in-1 Tool (*RC31*)
13. Handheld Mini Turbo Brush (*RCMTB*)
14. Filters Bags (*AHLR-2*)
15. Hard Floor Brush (*AHC-70*)

Prevention

Switch off the vacuum cleaner immediately if the air intake, the floor brushes, or the telescopic wand become blocked. Before starting the vacuum cleaner up again remove the substance causing the blockage:

1. Never use the vacuum cleaner in the immediate vicinity of hot objects and do not suck up hot objects such as cigarette ends or ashes.

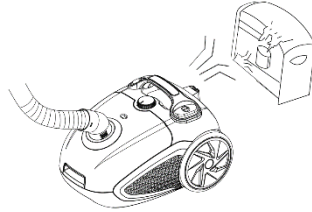

2. Only insert the plug in the outlet when your hands are dry.

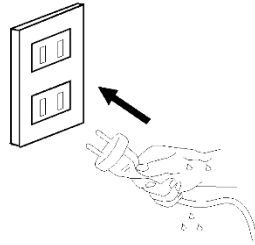

3. Please remove large or sharp objects from the floor before using the vacuum cleaner to avoid any possible damage.



4. Do not pull by the vacuum cord when pulling out the plug.

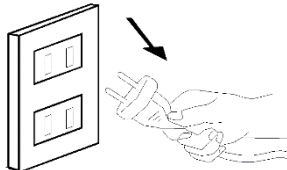

Preparing and Assembling the Vacuum Cleaner

Fit the hose on the vacuum cleaner by inserting the rotating hose connection into the vacuum cleaner until you hear a click. To remove the hose, press the button at the side of the hose connection and pull it out.



1. Assembling the telescopic wand and accessories

2.1: Fit the telescopic wand into the other end of the hose.

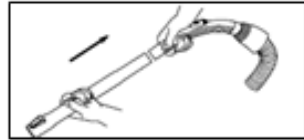

2.2: Adjust the length of the telescopic wand by pushing the locking mechanism down and pulling section of the wand to a suitable length. When storing, shorten the wand as far as possible.

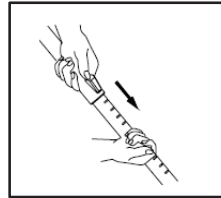

2.3: Fit the floor brush or other accessory into the telescopic wand.

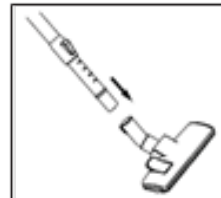

Floor Brush Combo

The floor brush has two settings. When cleaning hard surfaces (wood tile, etc.), the floor brushes should be extended. When cleaning carpets and mats, the brushes should be retracted. Press the brush peddle to switch between the two settings.

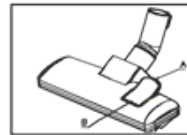
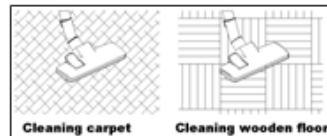

3-in-1 Tool

For radiators, corners, skirtings, furniture, etc.

Handheld Mini Turbo Brush

For stairs, rugs, furniture, drapes, etc.

Vacuum Cleaner Use

1. Before using the device first pull out a sufficient length of electric power cord and plug into the outlet. The yellow mark on the electric power cord is the maximum length that should not be exceeded. To switch on the device, press the foot pedal button .

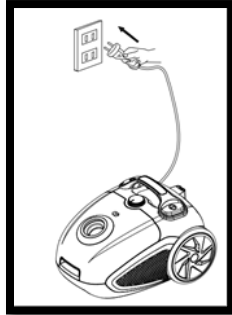

2. To rewind the power cord, press the button  with one hand and guide the cord with the other hand to ensure that it does not whip causing damage.

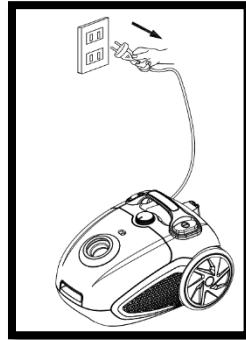

Caution:

Never operate the vacuum cleaner without the HEPA filter bag or motor filter, otherwise the device could be damaged.

Changing the HEPA filter bag

If the vacuum's suction is reduced, this may be because the HEPA filter bag needs changing. Raise the wand off the floor, set the suction force regulation to MAX, switch on vacuum cleaner using the on/off button, and keep an eye on the bag change indicator. If it is red, the HEPA filter bag should be changed.

1. Turn off and unplug cleaner.
2. Remove the hose, open bag cover by pushing latch up with fingers and lifting bag cover.
3. Grasp the cardboard at the top of the HEPA filter bag and carefully remove the bag from the vacuum cleaner.
4. Dispose of the HEPA bag.
5. Insert a new HEPA bag in the vacuum cleaner. The vacuum cleaner must never be used without the HEPA bag.
6. Close the vacuum cleaner again.
7. Always replace the HEPA bag after sweeping up large quantities of fine material.

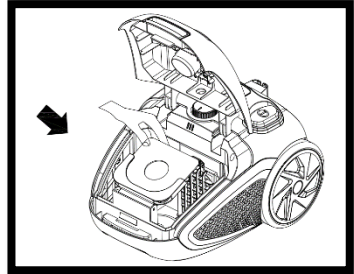
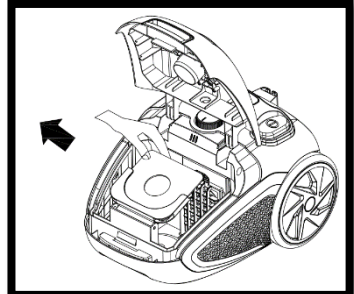

Cleaning the motor filter

1. The motor filter can be found in the dust bag container. It protects the motor from dust and should be cleaned periodically or when it is dirty, or if suction force is reduced.
2. Pull the filter holder up out of the vacuum cleaner.
3. Rinse the filter in warm water and allow it to dry completely.
4. Return the filter to the holder and replace the filter holder in the vacuum cleaner.

IMPORTANT! Never use the vacuum cleaner without a motor filter.

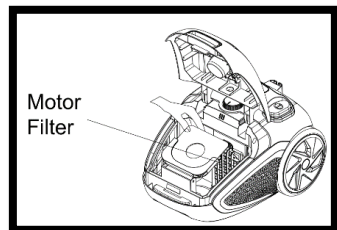

Transport and Storage

1. You can lift and carry the vacuum cleaner using the carrying handle. Never pull or lift the vacuum cleaner by the cord.
2. When storing vacuum turn vacuum off, unplug, and press the cord rewind button until the cord is fully rewound.

Cleaning

1. Unplug Vacuum.
2. Clean the vacuum cleaner by wiping it with a damp cloth. You must not use any solvents or abrasive cleaning agents.

Environmental Tips

Once any electronic product is no longer functional, it should be disposed of in such a way as to cause minimum environmental impact, in accordance with the regulations of your local authority. In most cases you can take such products to your local recycling station.

Atrix Rebel Red Canister Vacuum WARRANTY INFORMATION

Warranty/Service Information: For warranty service information, please contact Atrix or your local Atrix distributor.

Atrix Rebel Red Canister Vacuum Limited Warranty: To the original user purchasing the Atrix Rebel Red Canister Vacuum, Atrix warrants that the vacuum will be free of defects in material and manufacture for a period of one (1) year from the date of purchase. Should any failure to conform to this warranty appear within this period, Atrix will, at its option, repair or replace the defective product. It is the user's responsibility to return the product, freight prepaid, to Atrix International. These remedies are the user's exclusive remedies for breach of this warranty.

Exclusions to warranty coverage: The above warranty will not apply to any special configurations or to any units that have been modified, or damaged by negligence, misuse, accident or failure to follow Atrix's Instruction Manual. Consumable supplies, such as filters, accessories, and motor brushes are not covered by this warranty.

Disclaimer of Warranty: EXCEPT FOR THE IMPLIED WARRANTIES OF TITLE AND AGAINST PATENT INFRINGEMENT, ATRIX MAKES NO OTHER WARRANTIES WITH RESPECT TO THE ATRIX LIL' RED VACUUM CLEANER, EXPRESS OR IMPLIED, INCLUDING BUT NOT LIMITED TO ANY IMPLIED WARRANTY OF MERCHANTABILITY OR FITNESS FOR A PARTICULAR PURPOSE.

Limitation of Liability: ATRIX WILL NOT BE LIABLE UNDER ANY CIRCUMSTANCES FOR ANY COINCIDENTAL, SPECIAL, OR CONSEQUENTIAL DAMAGES OR ECONOMICAL LOSS, BASED UPON BREACH OF WARRANTY, BREACH OF CONTRACT, NEGLIGENCE, STRICT LIABILITY IN TORT OR ANY OTHER LEGAL THEORY, EVEN IF ATRIX HAS BEEN ADVISED OF THE POSSIBILITY OF SUCH DAMAGES INCLUDING, BUT NOT LIMITED TO LOSS OF PROFITS, REVENUE, EQUIPMENT USE, DATA OR INFORMATION OF ANY KIND. THE LIABILITY OF ATRIX SHALL NOT UNDER ANY CIRCUMSTANCE, EXCEPT AS EXPRESSLY PROVIDED HEREIN, EXCEED THE PRICE OF THE ATRIX REBEL RED VACUUM.

To Register your Warranty Visit:

www.atrix.com