

Installation and Operation Instructions

ELECTRIC FIREPLACE

X56WMEF1BLK X56WMEF1WHT

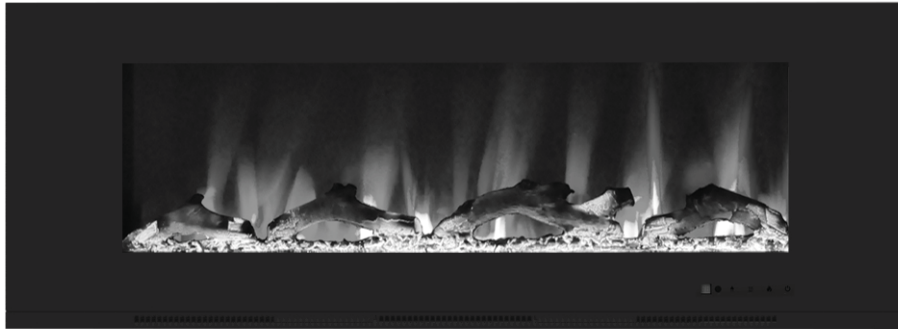

READ & SAVE THESE INSTRUCTIONS

Carefully read and review before assembling, installing, operating or maintaining this product. Observe all safety instructions and information.



FAILURE TO FOLLOW WARNINGS & OPERATIONAL INSTRUCTIONS CONTAINED IN THIS MANUAL CAN RESULT IN PROPERTY DAMAGE OR PERSONAL INJURY.



TABLE OF CONTENTS

Tool list	2
Assembly Instructions	2-3
Important Safety Instructions	3-4
Listing Approvals	5
Glass Particles Installation Instructions	6
Product Dimensions	7-8
Installation	9-10
Operating Instructions	11
Remote Control Instructions	11
Temperature Limiting Control	12
Trouble Shooting	12
Cleaning	12

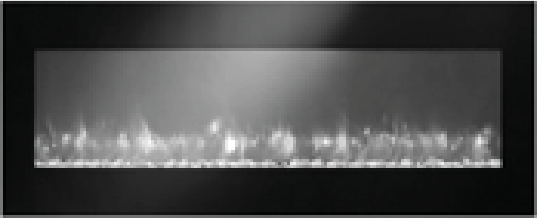
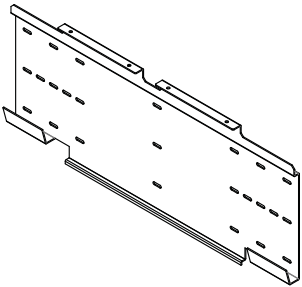
Suggested tools: Phillip head screw driver, power drill, drill bit, and a tape measure. Unit needs to be hung on wall stud for more security and stability.

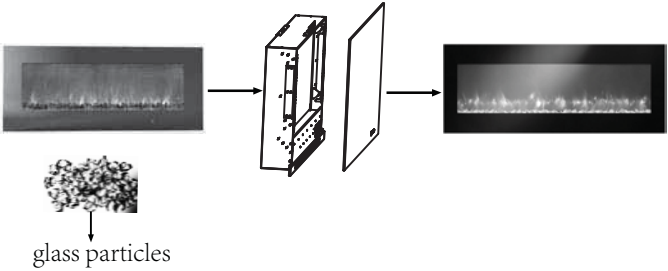
<p>(1) Fireplace assembly 1 PC</p> 	<p>(2) Steel holder 1 PC</p> 
<p>(3) Remote Control 1PCS</p> 	<p>(4) Screw 8 PCS</p>  <p>∅ 4mm x 40mm</p>
<p>Care and Cleaning Instructions: Before using, wipe with a clean, dry cloth. Avoid rubbing or scratching the surface with rough or abrasive objects.</p>	<p>Replace the faux fire log set with glass particles:</p>  <p>glass particles</p> <p>Remove the glass pane, then replace the faux fire log set with glass particles.</p>
<p>Assembly Tool Required</p> <p>Phillips Screwdriver</p>	

Tool List: drill bit, drill, tape measure and pencil.

X56WMEF1BLK X56WMEF1WHT
Remote Control Electric Wall-Mount Fireplace
Assembly Instructions

Quick Reference Guide

1. Prior to plugging your heater into a power outlet, first verify that the circuit breaker for the outlet is on.

2. The heater may emit a slight, harmless odour when first used. This odour is normal and it is caused by the initial heating of internal heater parts and will not occur again.
3. If the heater does not emit heat, Consult your User's Guide for further information.

CAUTION

RISK OF ELECTRIC SHOCK

DO NOT OPEN THE UNIT

NO USER-SERVICEABLE PARTS INSIDE

HIGH TEMPERATURE

KEEP ELECTRICAL CORDS, DRAPERY AND OTHER FURNISHINGS AT LEAST 1 METRE / 3 FEET FROM FRONT AND SIDES OF THE HEATER.

WARNING

RISK OF FIRE - KEEP COMBUSTIBLE MATERIAL AWAY FROM TOP OF HEATER.

SERVICING SHOULD BE DONE ONLY WHILE THE HEATER IS UNPLUGGED FROM POWER SUPPLY.

The flame effect on the wall hanging fireplace is created by LED surface mounted components that are designed to last the life of the product. Do not remove back cover of heater, no user serviceable parts are contained within.

IMPORTANT SAFETY INSTRUCTIONS

When using electrical appliances, to reduce the risk of fire, electric shock and injury to persons, basic precautions should always be followed, including the following:

1. Read all instructions before use.
2. This heater is hot when in use. To avoid burns, do not let bare skin touch hot surfaces. If provided use handle when moving this heater.
3. Keep combustible materials such as furniture, pillows, bedding, papers, clothes, and curtains at least 4" / 7cm away from the front of heater and keep them away from the sides of heater.
4. Extreme caution is necessary when any heater is used by or near children or invalids and whenever the

heater is in operation it must not be left unattended.

5. Always unplug the heater when not in use.
6. Do not operate any heater with damaged cord or plug or after the heater has malfunctioned or has been dropped or damaged in any manner. Return heater to an authorised service facility for repair.
7. Do not use outdoors.
8. This heater is not intended for use in bathrooms, laundry areas and similar indoor locations. Never locate heaters where it may fall into a bath tub or other water container.
9. Do not run cord under carpeting. Do not cover cord with throw rugs, runners or the like. Arrange cord away from traffic areas and where it will not be tripped over.
10. To disconnect heater, turn control to off, then remove plug from outlet.
11. Connect to properly grounded outlet only.
12. Do not insert or allow foreign objects to enter any ventilation or exhaust opening as this may cause an electric shock or fire, or damage the heater.
13. To prevent a possible fire, do not block air intake or exhaust in any manner
14. Do not use on soft surfaces, like a bed, where openings may become blocked.
15. A heater has hot and arcing or sparkings parts inside. Do not use it in areas where gasoline, paint or flammable liquids are used or stored.
16. Use this heater only as described in manual. Any other use not recommended by the manufacturer may cause fire, electric shock, or injury to persons.
17. Avoid the use of an extension cord because the extension cord may overheat and there is a risk of fire.
18. Do not strike the heater glass.
19. Always use properly grounded, it may break fused and polarized outlets.
20. Always disconnect power before performing any cleaning or maintenance, or relocation of the heater.
21. When transporting or storing the heater keep in a dry place, free from excessive vibration and store so as to avoid damage.
22. The flame effect is powered by a motor and it is normal for the motor to make some noise as it slowly rotates and helps to create the beautiful 3D flame effect. Some rooms have more or less furnishings than others resulting in varying noise amplification.
23. Whilst every effort is made to ensure packing materials are kept outside of the plastic bag which covers your heater in the box, there is a remote chance that some packing may lodge itself in the heater part of the unit. If you notice this on close inspection, please remove it. When turning your heater on for the first time it is normal for the heater to emit a little 'new heater' smell which quickly passes.
24. You may notice some light coming from under or from the sides of the unit. This is normal and the holes allow the unit to 'breathe'. Do not attempt to block these holes.
25. This heater is to be used on a 110 / 120 V, 11.2AMP, grounded circuit. Do not use in an outlet controlled by a switch or dimmer switch. The cord supplied with the heater, has a 2 blade plug, the round pin on the plug is for grounding purposes. If a 2 slot receptacle is not available, an adapter must be used, and the adapter must be properly grounded to the outlet box. Avoid plugging other appliances into the same circuit as heater.

LISTING APPROVALS

This heater has been tested in accordance with the CSA Standards.

Model Number:	X56WMEF1BLK X56WMEF1WHT
Description:	Wall Mount Electric Fireplace
Voltage:	120V AC, 60Hz
Watts:	MAX 1300 W
Length:	56.0"
Height:	20.2"
Depth:	4.7 "

GLASS PARTICLES INSTALLATION INSTRUCTIONS

- 1.To remove the outer glass around the bracket, undo the mounting screws (red arrows) (①)
- 2.Remove the outer glass (②)
- 3.Carefully take out the log set, adjust the screws (red arrows) (③、④)
- 4.Gently put the glass crystals into place (⑤、⑥)
- 5.Be cautious about the outer glass bracket screws (⑦)

①



②



③



④



⑤



⑥



⑦



PRODUCT DIMENSIONS

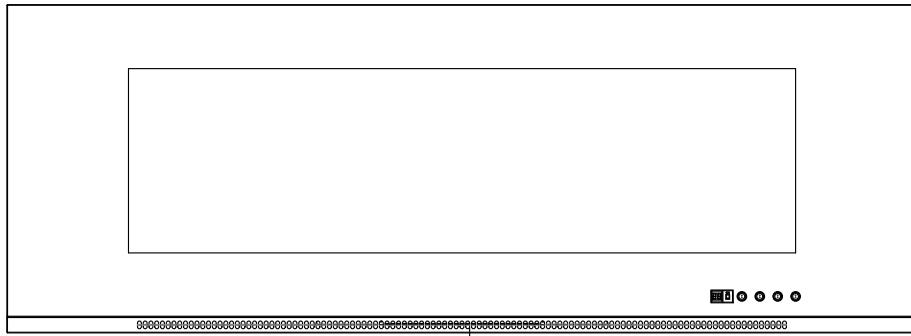

DO NOT COVER

56.0"

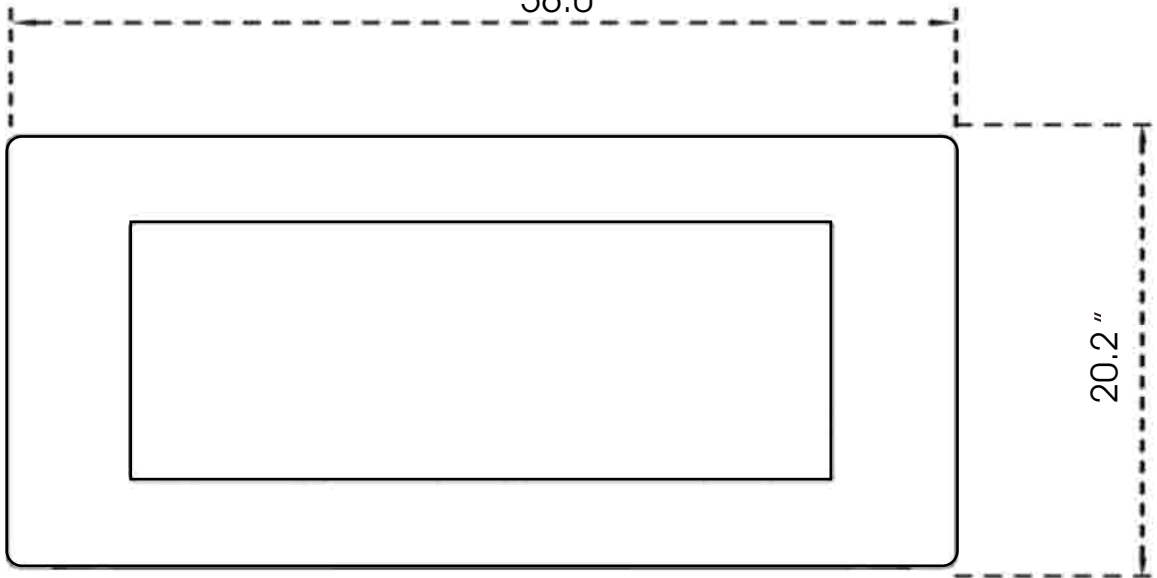

20.2"

FRONT VIEW

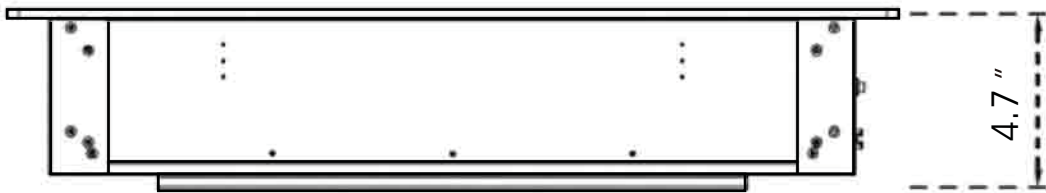

4.7"

BOTTOM VIEW



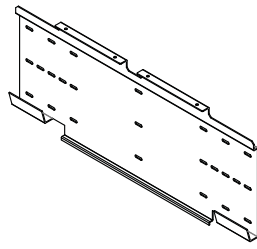

Mounting Bar

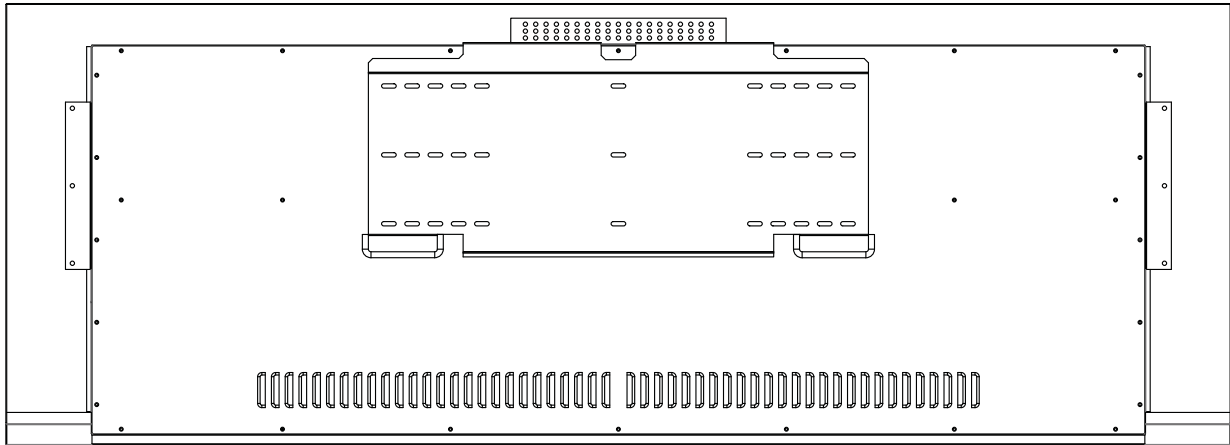

BACK VIEW

PRODUCT DIMENSIONS

WARNING: Due to high temperatures, this electric fireplace should be located out of traffic. Keep combustible materials such as furniture, pillows, bedding, papers, clothes and curtains at least 0.9m / 36 inches the top of the heater.

WARNING: Never locate this electric fireplace where it may fall into a bathtub or other water container.

CAUTION: Do not expose the electric fireplace to the elements (such as rain, etc)

WARNING: To prevent contact with sagging or loose insulation, the electric fireplace must not be installed against a vapor barrier or exposed insulation. Localized overheating could occur and a fire could result.

UNPACKING AND TESTING FIREPLACE

Carefully remove the unit from the box. Prior to installing the unit, test to make sure the unit operates properly. To do this, plug the unit's power supply cord into a conveniently located 120 Volt grounded outlet.

INSTALLATION

WARNING: RISK OF FIRE! The power cord must not be pinched or against a sharp edge. Secure cord to avoid tripping or snagging to reduce risk of fire, electric shock or personal injury. Do not run cord under carpeting. Do not cover cord with throw rugs, runners or the like. Arrange cord away from traffic area and where it will not be tripped over.

WARNING: RISK OF FIRE! To prevent a possible fire, do not block air intake or exhaust in any manner. Do not use on soft surfaces where openings may become blocked.

WARNING: RISK OF FIRE! Do not place insulation against the fireplace.

WARNING: This electric fireplace is tested and listed for use only with the approved optional accessories. Use of optional accessories not specifically tested for this electric fireplace could void the heater warranty and / or result in a safety hazard.

WARNING: If the information in these instructions is not followed exactly, a fire or explosion may result causing property damage, personal injury or death. Do not store or use gasoline or other flammable vapors in the vicinity of this or any other heater.

INSTALLATION

Model 1:

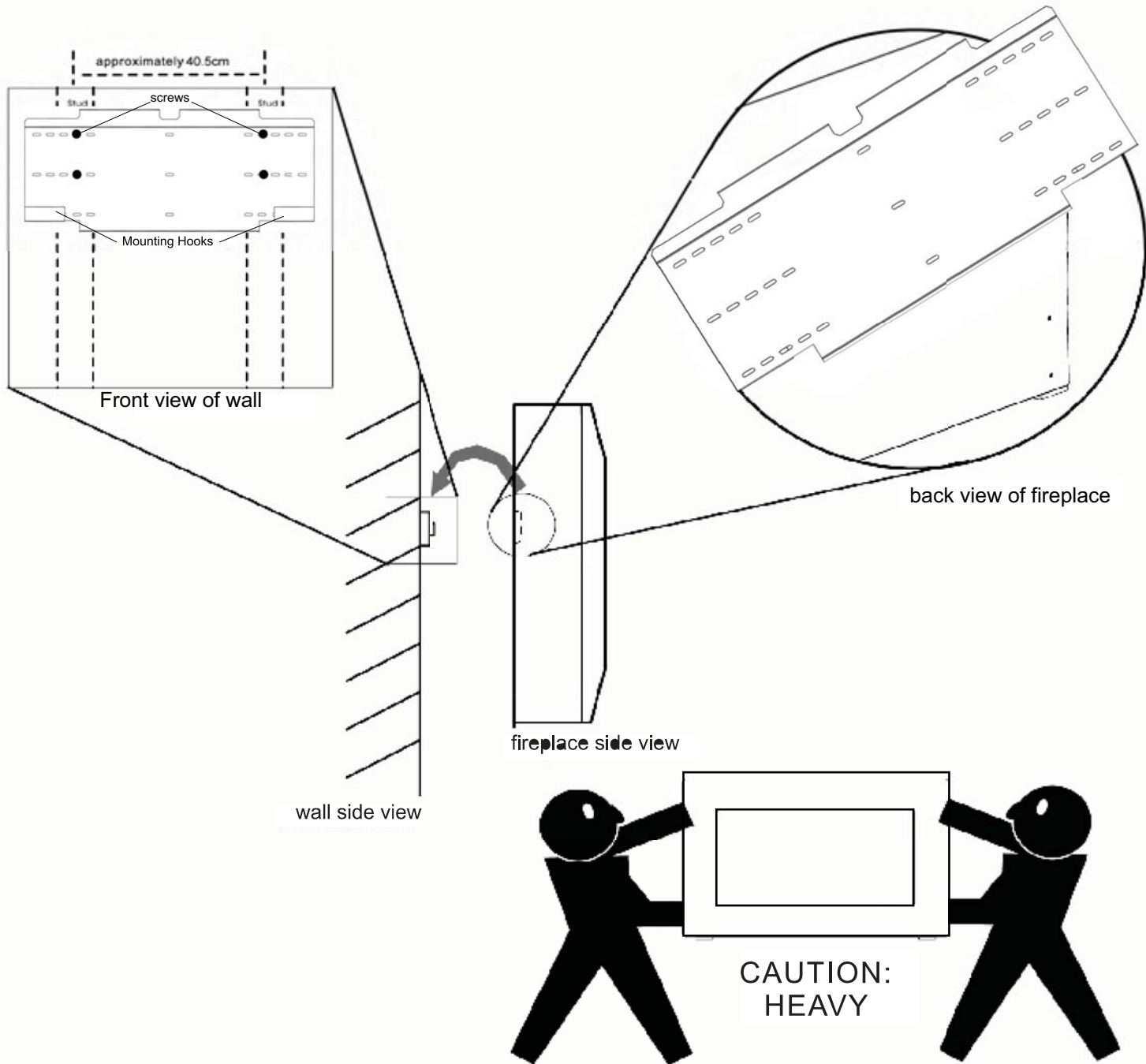

Model 2:

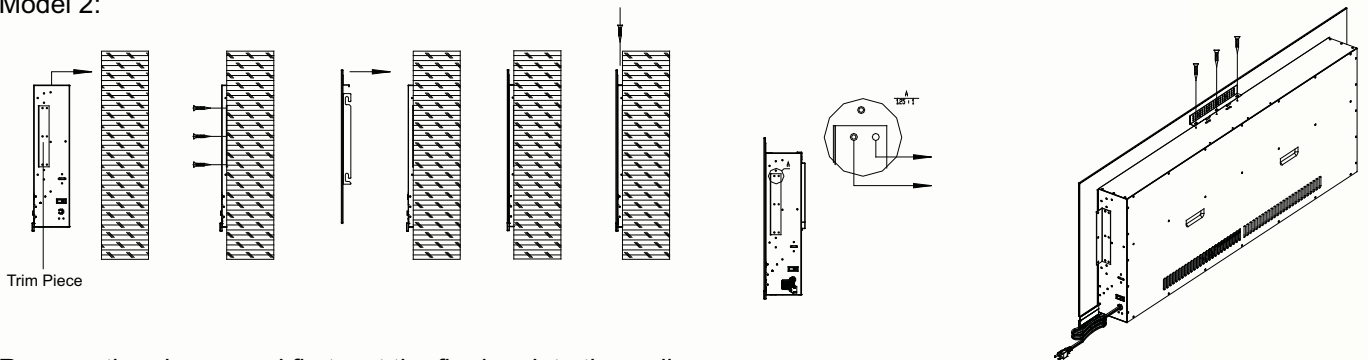

Remove the glass panel first, set the fire box into the wall.
Secure the side trim pieces on the wall with screws.
Reinstall the glass panel onto the firebox with screws.

OPERATING INSTRUCTIONS

The manual controls are located on the left side of the fireplace.

LOCATION

The master power switch is located on the right side of the appliance. The control panel is on the right corner of the glass.

MASTER SWITCH

The master switch controls the power supply to the appliance. Turn the switch to “I” to connect power and turn the switch to “O” to cut the power. There will be a chiming sound when turning to “I”.

You have the following controls:

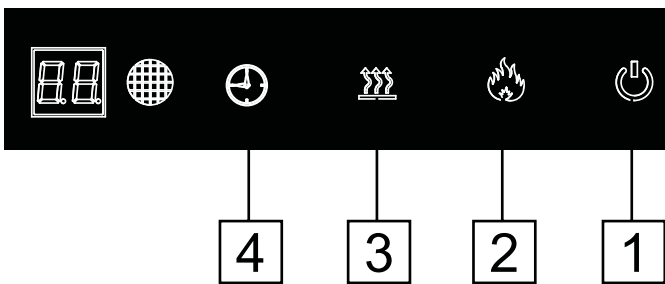

1. Power ON/OFF: Touch the button once (flame will light up) to turn power on for all functions, Touch the button once more to turn all functions off.
2. Press the button to change the flame brightness, there are 5 levels (L1 to L5).It appears the related flame number on the digital screen.
3. Low heat:700 watts(LO) , High heat: 1350 watts(HI) Press the button once(the digital screen shows ‘L’). Press the button a second time(the digital screen shows ‘H’). Press the button a third time to turn the heater off.
- 4.TIMER Set the timer using the button (1 to 9 hours), press button once for 1 hour increments.

REMOTE CONTROL INSTRUCTIONS

1. Install the 2X AAA batteries in the remote control.
2. Turn the master switch on the e-fireplace to ‘I’ so that it can receive the signal from the remote control.
3. Press the button 1 to change the flame brightness, there are 5 levels (L1 to L5). It appears the related flame number on the digital screen.
- 4.This electric fireplace is equipped with a timer ranging from 1 hour to 9 hours. Press the timer button 2 once for 1hour, twice for 2 hours etc.
5. CAUTION: Never leave the e-fireplace unattended while heating.
6. Refer to above control buttons / functions for the other buttons on the remote control.

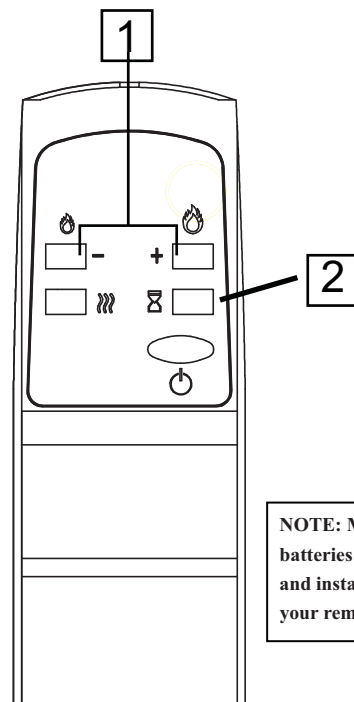

NOTE: Make sure the batteries are fully charged and installed correctly in your remote control.

The remote control uses 2X AAA batteries

TEMPERATURE LIMITING CONTROL

This heater is equipped with a Temperature Limiting Control. Should the heater reach an unsafe temperature, (115 degrees Celsius) the heater will automatically turn off. To reset: Unplug unit from wall, wait for 5 minutes, plug back in and continue to use.

TROUBLE SHOOTING



WARNING: Turn off and unplug the fireplace and let cool completely before servicing.

SYMPTOM	POSSIBLE CAUSES	CORRECTIVE ACTION
Fireplace doesn't work.	Fireplace inner components are overheating or the home circuit breaker has tripped.	Reset switch by turning master switch off and waiting for 5mins, then turning it back on.
Flame is not moving.	Wiring may be loose or the flame motor may be defective.	Call customer service for instructions.
Dim or poorly visible flame or glass pebbles aren't glowing.	LED lights are burnt out or the wiring is loose.	Call customer service for instructions.
Flame sputters	Flame motor is defective.	Call customer service for instructions.
Remote control does not work.	Low battery. Master switch is in "OFF" position.	Change the battery for remote control. Check to make sure the master switch is turned on.
Circuit breaker trips or fuse blows when the unit is on.	Improper circuit current rating.	Call customer service for instructions.
Heater does not provide heat when turned on.	Thermal switch has been tripped. Circuit breaker has been tripped.	Turn the unit off and unplug the unit for 5mins. Plug back in and turn on the unit. Turn off circuit breaker that supplies electricity to the unit, wait 5mins, then flip circuit breaker back on.
Appliance turns off and will not turn on.	Appliance has overheated and its safety device has caused the thermal switch to disconnect. House circuit breaker has tripped.	Unplug the appliance, allow to cool for 15mins, then plug back in. Reset the house circuit breaker.

CLEANING

Turn heater OFF and unplug from outlet. Use a vacuum or duster to keep heat and vent area clean from dust and dirt. The exterior should be cleaned with a damp cloth or duster. Do not use abrasive cleaners, liquid sprays, or any other cleaner that may scratch the surface.