

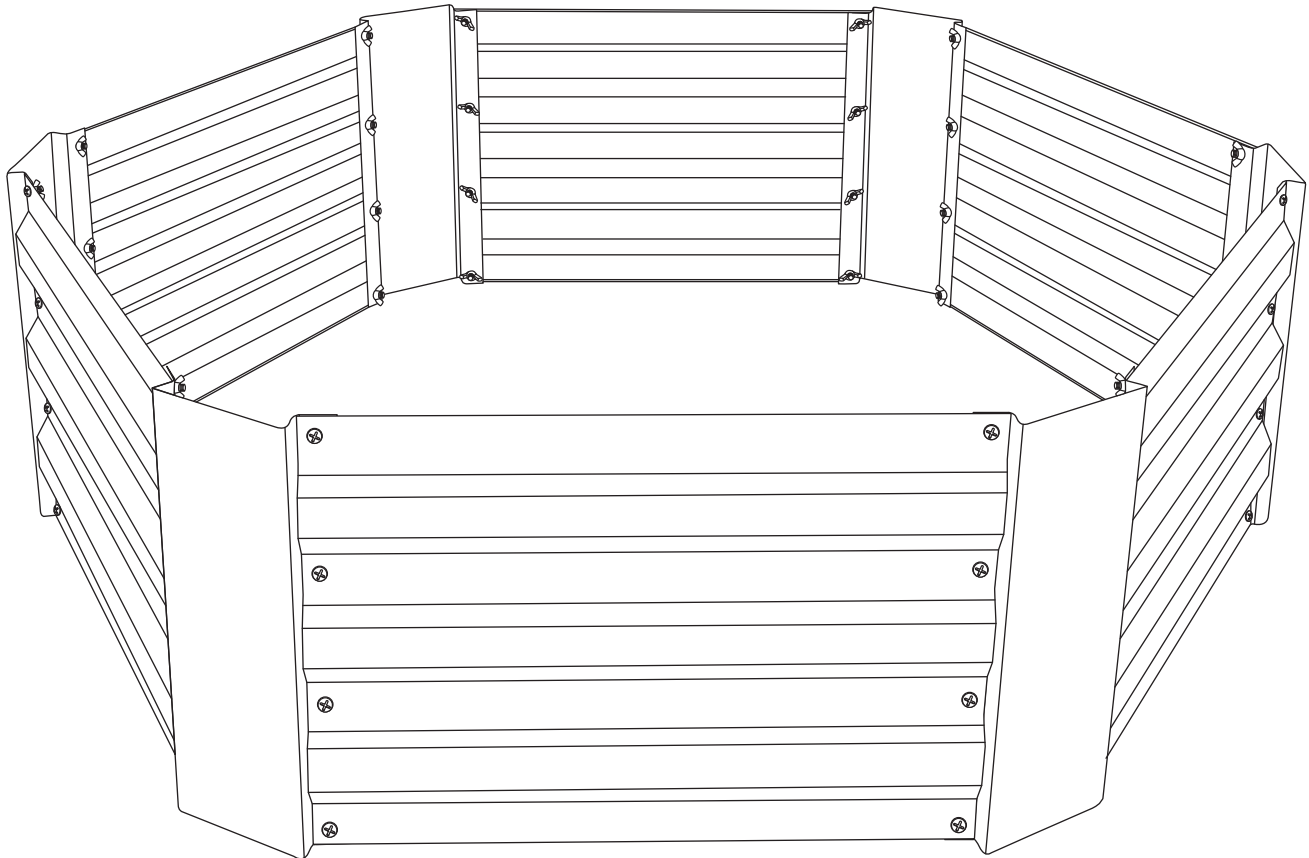







HEXAGON-SHAPED GALVANIZED STEEL RAISED GARDEN BED

Review all care and assembly information carefully before using this product. Save this manual for future reference.
Assemble components on a soft, clean surface to avoid damaging the finish.



 **Inspect packaging to ensure all parts are accounted for before disposing of packing materials.**
 Save the packing slip.

No.	PARTS		QTY.
A		Side Panel	6
B		Corner	6
C		M6x10mm Bolt	48
D		Wing Nut	48

TOOLS REQUIRED (not included)	
	 Phillips Screwdriver



CAUTION:

SHARP EDGES

USE EXTREME CAUTION

◀ WEAR GLOVES DURING ASSEMBLY ▶



WARNING



CHOKING HAZARD — This item contains small parts that can be swallowed. Keep children and pets away during assembly.

ASSEMBLY

! HELPFUL HINTS !

- Do not tighten any bolts until the entire unit is loosely assembled. If hardware is tightened too soon, mounting holes may not align and parts may not easily fit together.
- Ensure panels are installed with the rolled edges facing the inside of the bed.
- Review all steps and understand assembly before beginning.



CAUTION: Sharp edges.
Wear gloves during assembly.

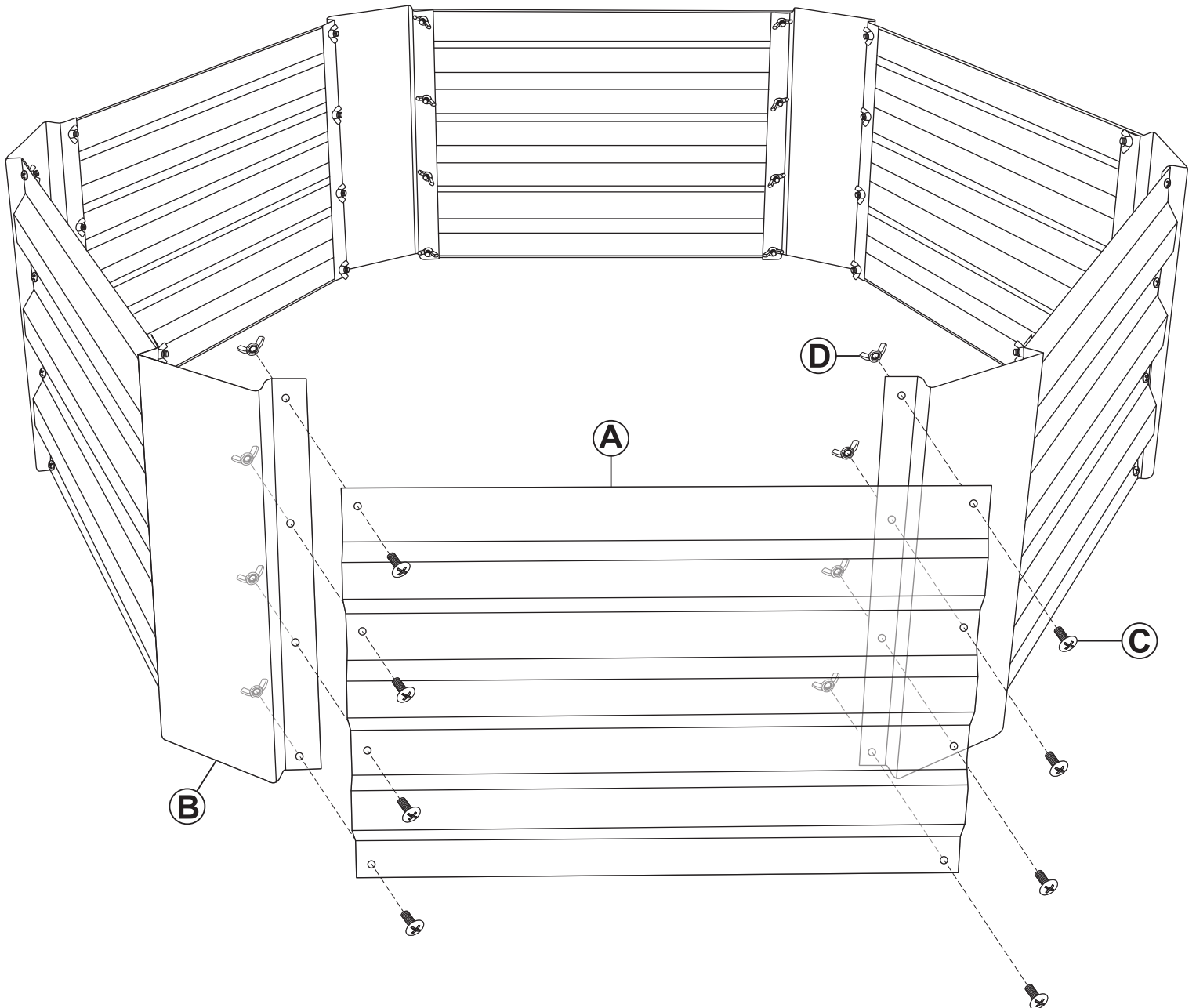

1. Align Corner (B) on the inside edge of Side Panel (A).
2. Loosely fasten Side Panel (A) and Corner (B) by hand-tightening four Bolts (C) and Wing Nuts (D).
3. After all pieces have been loosely assembled, fully tighten all wing nuts.

USE & CARE

- This garden bed provides ergonomic access to plants and can eliminate the need to till the soil each year as long as the soil is not packed down. Avoid stepping inside the bed!
- Prepare the site before installation. Level the ground and remove existing vegetation. Landscaping fabric can be used under the beds; a double layer is recommended for beds placed directly on a lawn.
- A layer of gravel or stone can be used at the bottom for improved drainage.
- Loosely hand-tighten all nuts and bolt sets first, position the bed, then tighten. After assembly, check that all fastening points are fully secured.
- Galvanized metal beds do not require maintenance and are built to withstand years of exposure to outdoor elements.
- The galvanized finish protects the steel from corrosion. Over time, galvanized steel will fade, and some discoloration is normal. Minor surface rust on edges and hardware is to be expected and should not affect the structural integrity of the product.

SAFETY STATEMENTS & WARNINGS

- Wear gloves during assembly to prevent personal injury.
- Do not stand on, or lean objects against the bed wall. Doing so may damage the product.
- Do not let children play in or around the garden bed.
- Using this item for applications other than gardening will void the product warranty.

Any modification to the product or failure to follow recommended care will void the product warranty.

If you experience issues with assembly or the product was damaged during shipping, please contact our customer service team through one of the methods mentioned at the top of page 1. Please have the item number and order information ready to expedite response time.



WARNING:

Manufacturer and seller expressly disclaim any and all liability from personal injury, property damage or loss, whether direct or indirect, or incidental, resulting from the incorrect attachment, improper use, inadequate maintenance, or neglect of this product.