

CABANA COOP Assembly Manual

SKU#2432296

Producer's
PRIDE

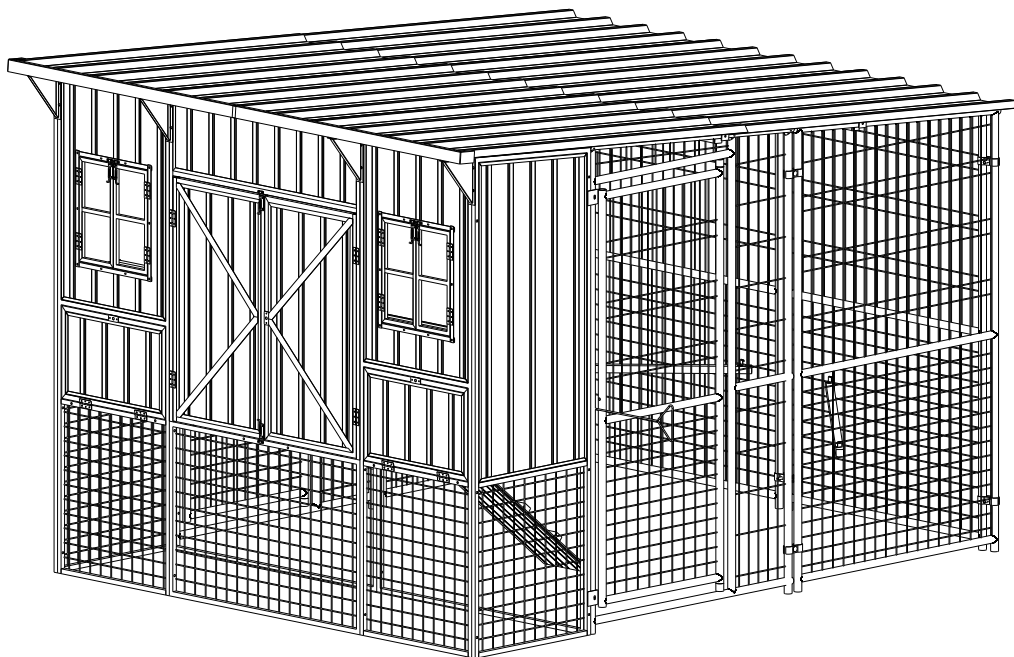

Tools required for assembly (not included)

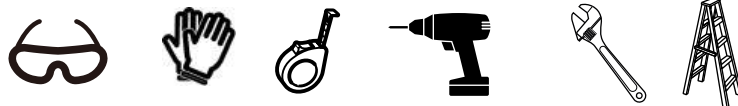



Distributed by: TRACTOR SUPPLY COMPANY
5401 VIRGINIA WAY, BRENTWOOD, TN 37027
For customer support, call: 1-888-376-9601

www.TractorSupply.com

MADE IN CHINA



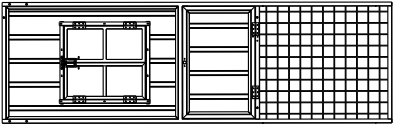
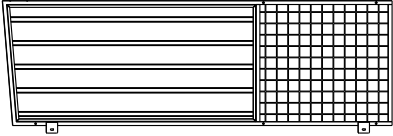
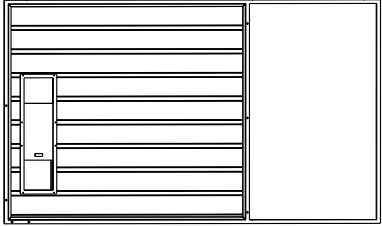
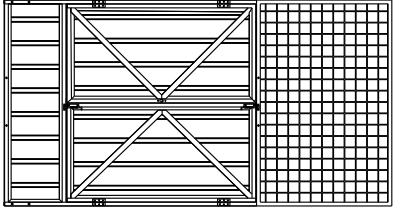
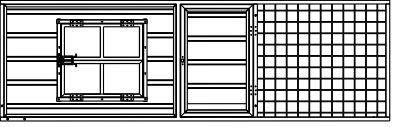
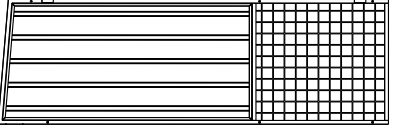
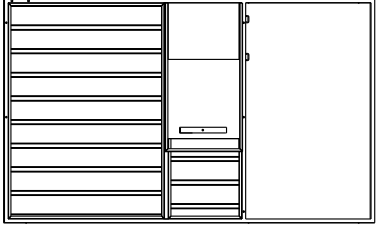
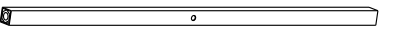



PARTS LIST

Please check the parts and quantities before assembly

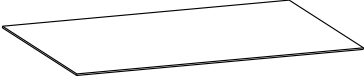
| Part# | Description | Drawing | Qty. |
|-------|---------------------------|--|------|
| 1 | Coop Front Panel-Left |  | 1 |
| 2 | Coop Left Panel |  | 1 |
| 3 | Coop Back Panel-Right |  | 1 |
| 4 | Coop Front Panel-Middle |  | 1 |
| 5 | Coop Front Panel-Right |  | 1 |
| 6 | Coop Right Panel |  | 1 |
| 7 | Coop Back Panel-Left |  | 1 |
| 8 | Coop Floor Support Tube-1 |  | 6 |
| 9 | Coop Floor Support Tube-2 |  | 1 |
| 10 | Coop OSB Floor |  | 2 |

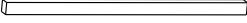

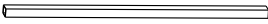
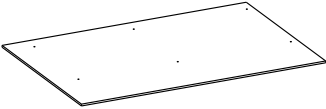
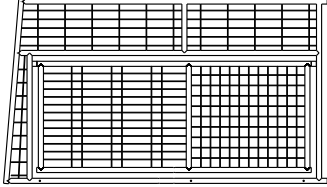
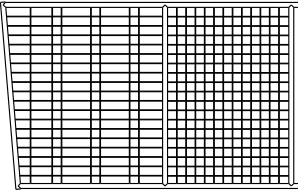
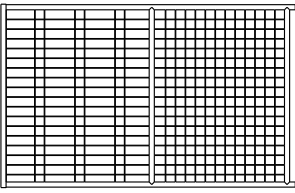

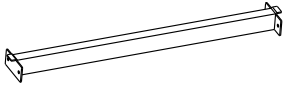
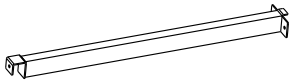
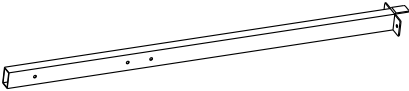

PARTS LIST

Please check the parts and quantities before assembly

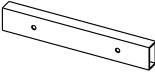
| Part# | Description | Drawing | Qty. |
|-------|-------------------------|--|------|
| 11 | Coop PVC Floor |  | 2 |
| 12 | Long Roosting Bar - 1 |  | 2 |
| 13 | Short Roosting Bar |  | 2 |
| 14 | Long Roosting Bar - 2 |  | 2 |
| 15 | Coop Roof Support Tube |  | 4 |
| 16 | Coop Roof Board |  | 2 |
| 17 | Run-Door Panel |  | 2 |
| 18 | Run-Side Panel 1 |  | 2 |
| 19 | Run-Side Panel 2 |  | 2 |
| 20 | Run Roof Support Tube-1 |  | 2 |
| 21 | Run Roof Support Tube-2 |  | 2 |
| 22 | Run Roof Support Tube-3 |  | 4 |
| 23 | Run Roof Support Tube-4 |  | 2 |

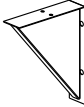
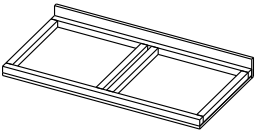
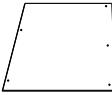

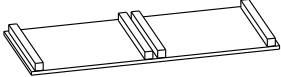
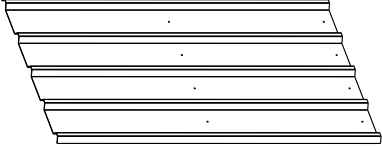
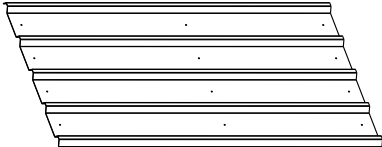
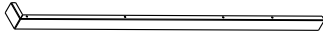
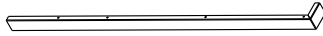

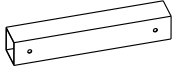







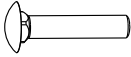
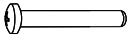

PARTS LIST

Please check the parts and quantities before assembly

| Part# | Description | Drawing | Qty. |
|-------|------------------------------|--|------|
| 24 | Connecting Tube |  | 2 |
| 25 | Connector Plate |  | 1 |
| 26 | Triangle Support |  | 4 |
| 27 | Nesting Box Floor Panel |  | 2 |
| 28 | Nesting Box Side Panel |  | 4 |
| 29 | Nesting Box Divider |  | 2 |
| 30 | Nesting Box Top Board |  | 2 |
| 31 | Coop Roof Panel -1 |  | 3 |
| 32 | Coop Roof Panel -2 |  | 3 |
| 33 | Eave-1 |  | 1 |
| 34 | Eave-2 |  | 1 |
| 35 | Ramp |  | 1 |
| 36 | Ramp Hook |  | 2 |
| 37 | Roosting Bar Connecting Tube |  | 1 |

PARTS LIST

Please check the parts and quantities before assembly

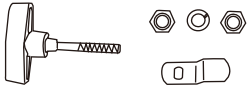
| Part# | Description | Drawing | Qty. |
|-------|---------------------------------------|---|------|
| 38 | Roosting Bar Holder |  | 6 |
| 39 | Roosting Bar Hook |  | 4 |
| 40 | Access Door Sliding Handle |  | 1 |
| 41 | 32-32 Clamp |  | 20 |
| 42 | M10x40 Bolt |  | 10 |
| 43 | M6x50 Bolt |  | 30 |
| 44 | M6x35 Bolt |  | 24 |
| 45 | M6x25 Bolt |  | 2 |
| 46 | M6x16 Bolt |  | 20+1 |
| 47 | M4x20 Bolt |  | 1 |
| 48 | M10 Lock Nut |  | 10 |
| 49 | M6 Lock Nut |  | 32+3 |
| 50 | Self-tapping Screw 4x10mm |  | 58+2 |
| 51 | Self-tapping Screw with Washer 4x25mm |  | 12+3 |
| 52 | Self-tapping Screw 4x25mm |  | 20+2 |
| 53 | Hexagonal Self-tapping Screw 5.5x19mm |  | 46+4 |
| 54 | T-handle Lock with tongue |  | 3 |

Get Ready:

- Install one piece of part #38 (Roosting Bar Holder) at the specified locations on the back of panels #1, #2, #3, #5, #6, and #7 by Screws #50.

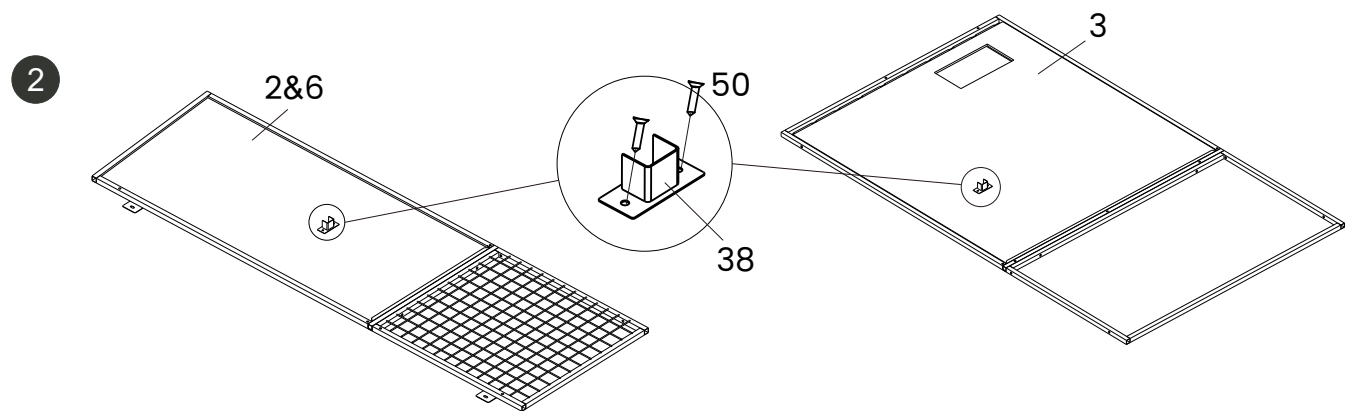
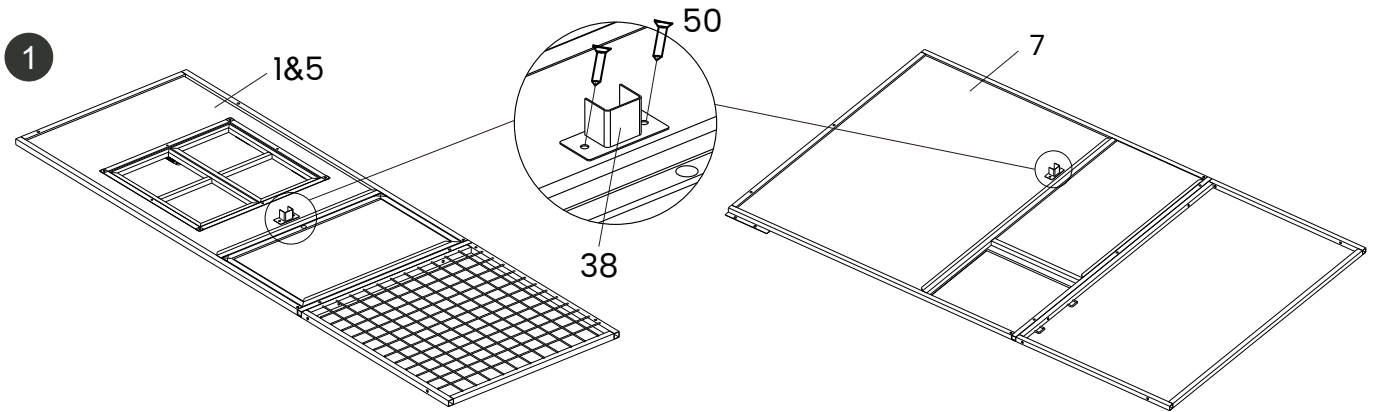

- Install part #27, #28 (2pcs), #29 & #30 to form a Nesting box, using Screws #52 . Repeat this step to make another Nesting Box.

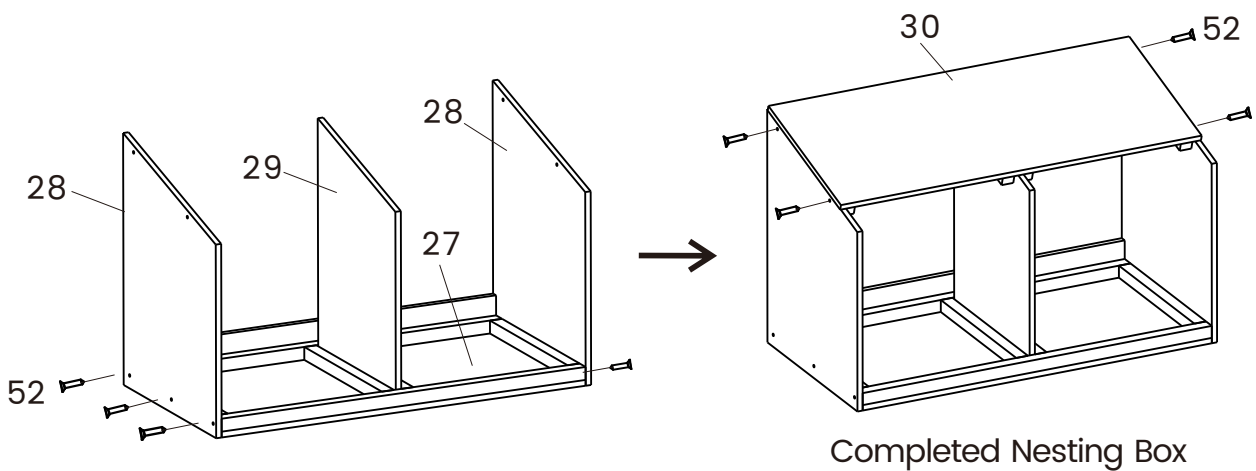

Step 3

- Assemble panel #7, and Connector Plate #25 through the pre-drilled holes.

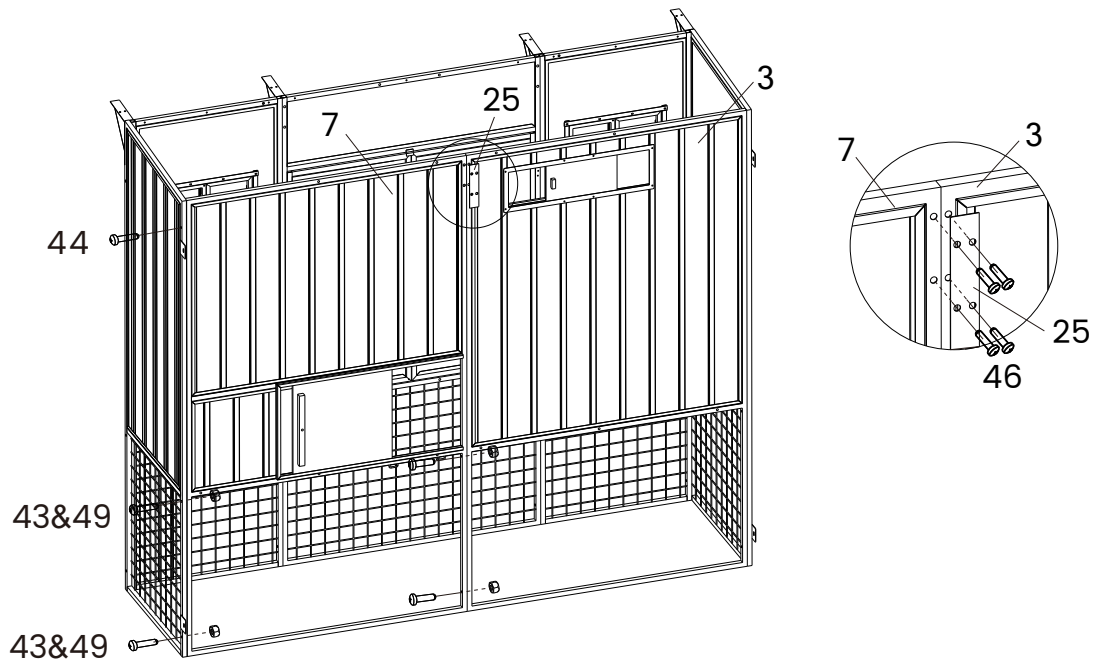

Step 4

- Install 6 units of #8 and 1 unit of #9 by Bolts #44.

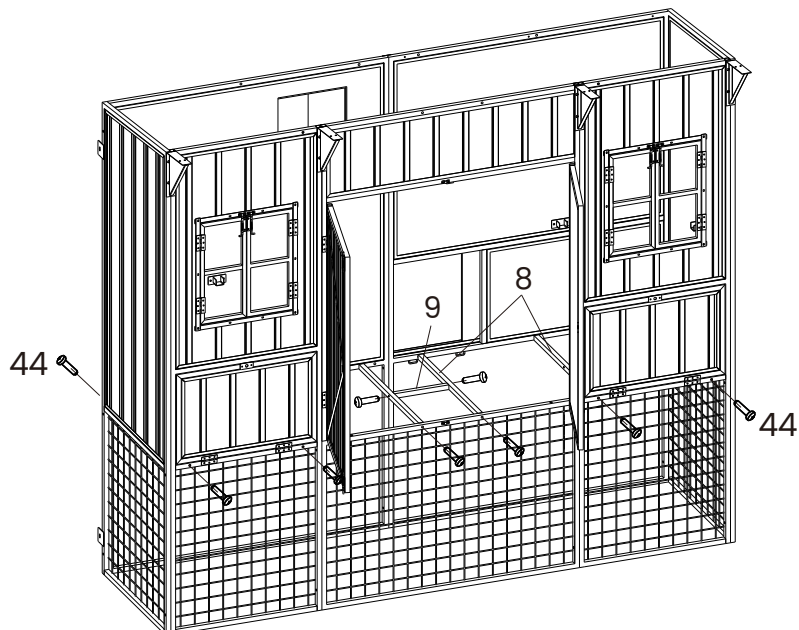

Step 5

- Insert two pieces of #12 evenly from both ends of #37, then secure with two pieces of #50.
- Place 2 pieces of #10 (Coop OSB Floor Board) in the chicken coop, and put 2 pieces of #11 (Coop PVC Floor Board) on top of #10. Then place Roosting Bars #12 and #13 on the Roosting Bar Holder (#38).

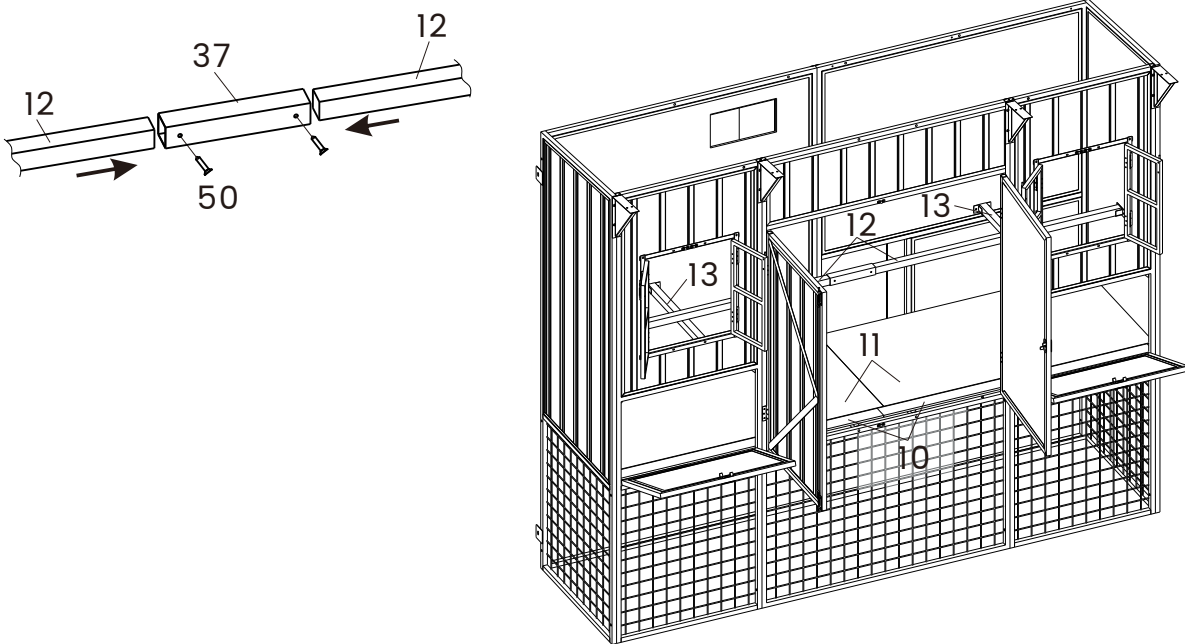

Step 6

- Place the pre-completed Nesting Box through the door to the position shown in the diagram.
- Assemble 4 pieces of part #15 by #44 through the pre-drilled holes.

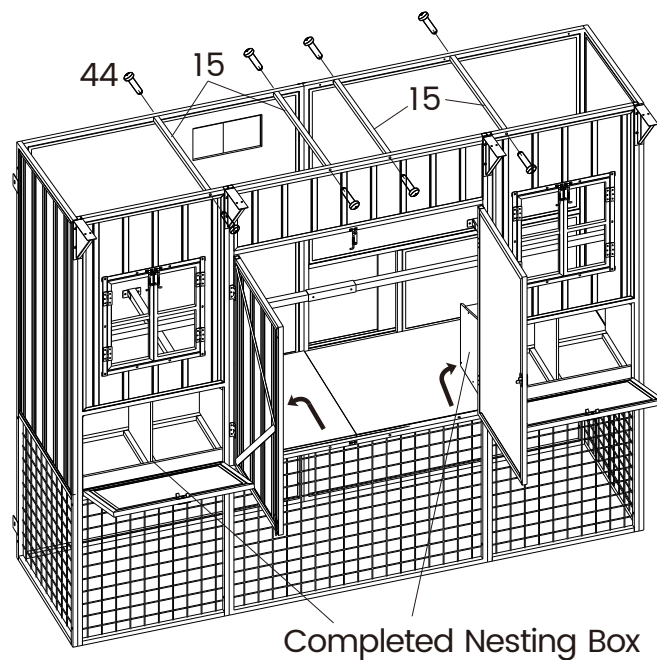

Step 7

- Assemble 2 pieces of part #16 by #51 through the pre-drilled holes. Connect #16 and #26 by #50 through the pre-drilled holes.

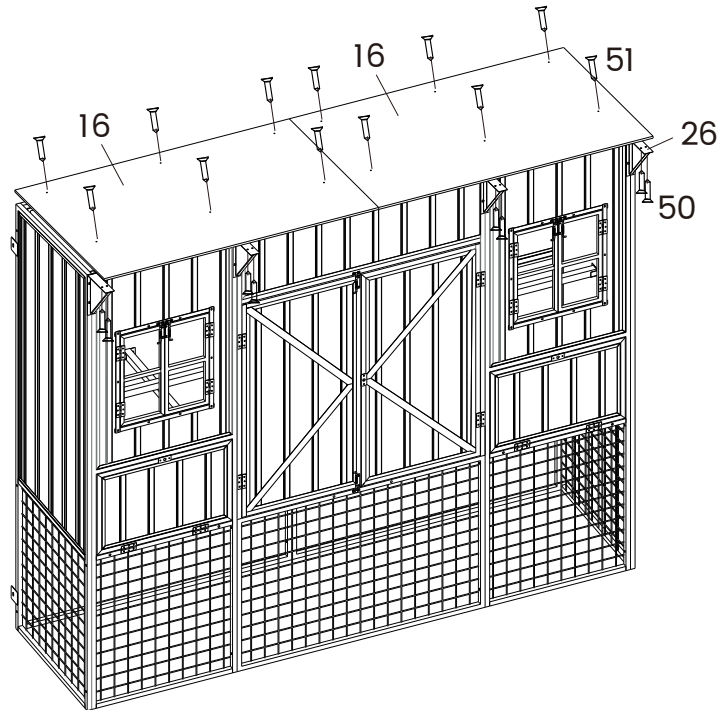

Step 8

- Assemble 2 pieces of # 17 and 2 pieces of # 18. Adjacent mesh panels are connected together using 2 pairs of #41 pipe clamps , #42 bolts , and #48 nuts .

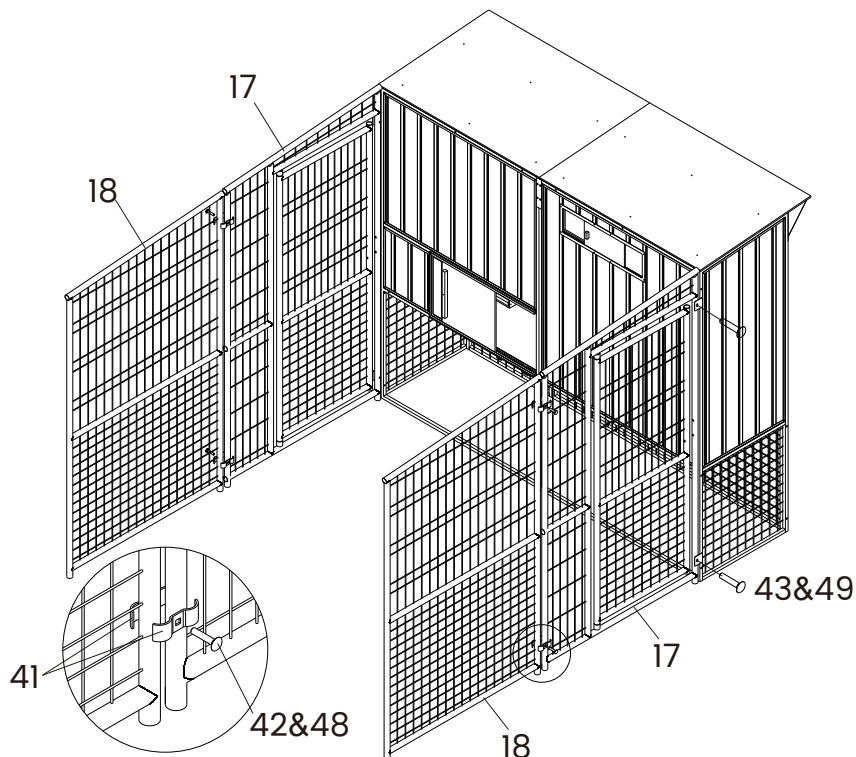

Step 9

- Assemble Ramp #35 and 2 hooks #36 by #45 and #49, then place them in the indicated positions as shown in the diagram.
- Insert one end of #40 (Access Door Sliding Handle) through the mesh of #17, then secure it to the sliding door on Panel #7 by Bolt #47.

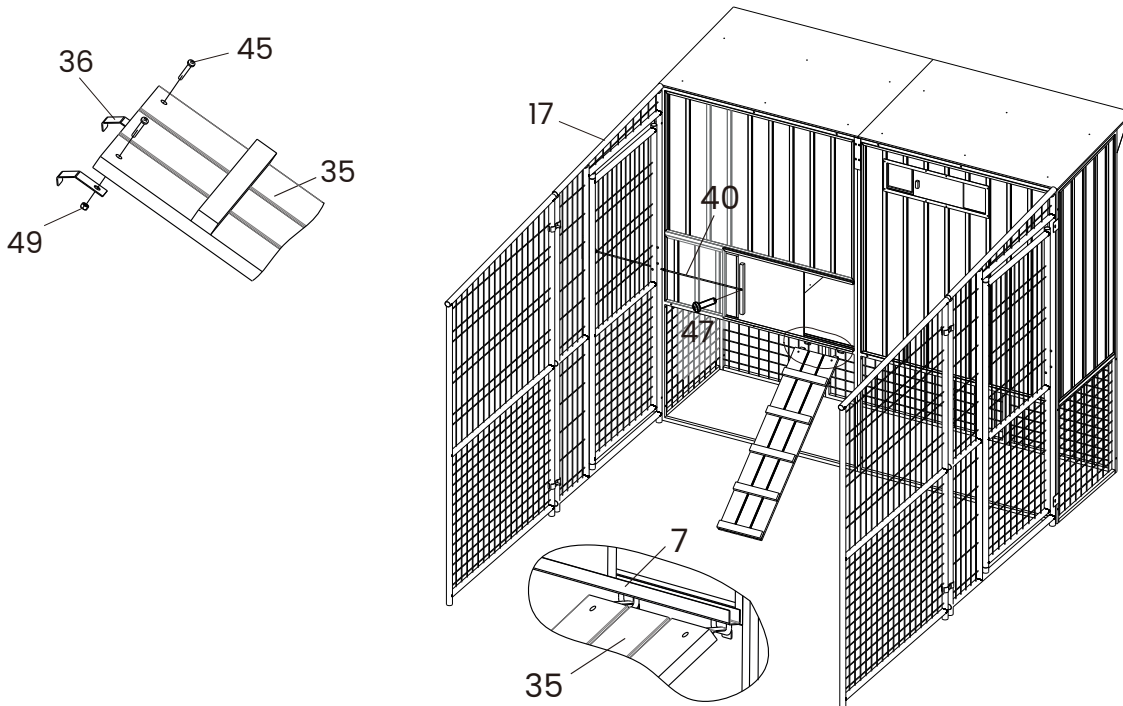

Step 10

- Assemble 2 pieces of #19 by #41 pipe clamps, #42 bolts, and #48 nuts .
- Note: The installation direction of the two pieces of #19 is shown in below cross-sectional diagram.

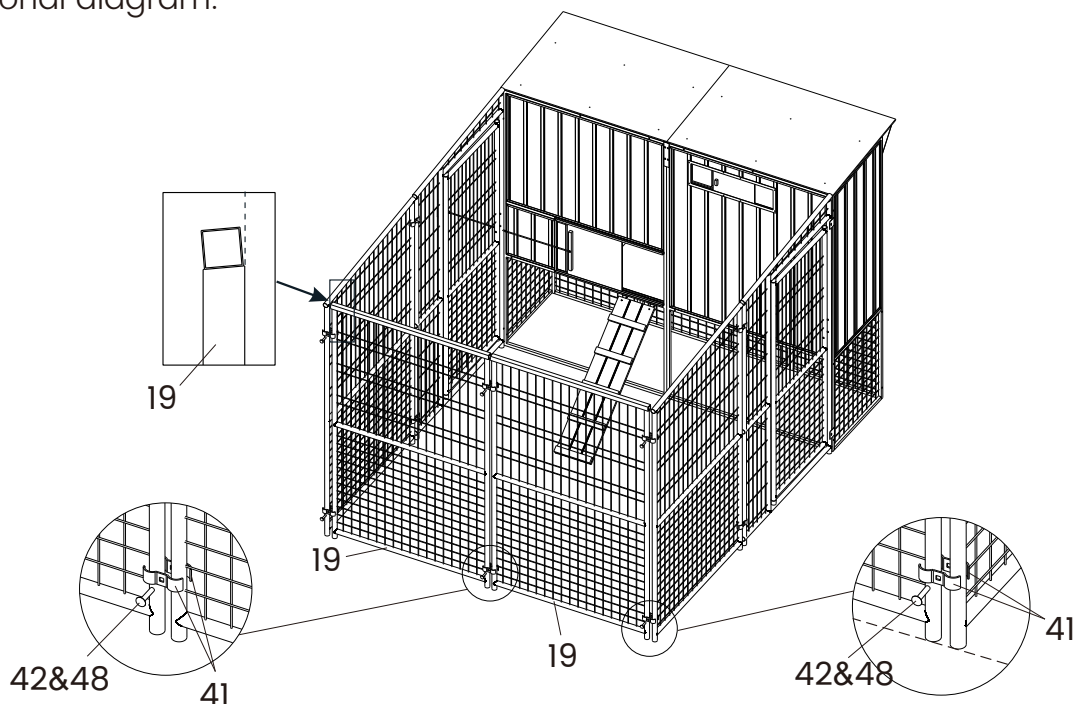

Step 11

- Assemble one piece each of #20, #23, and #24 together using #43 and #49. Repeat this to get another same group of tube.
- Place tubes #21 and #22 as shown and assemble the whole structure by #43 and #49.

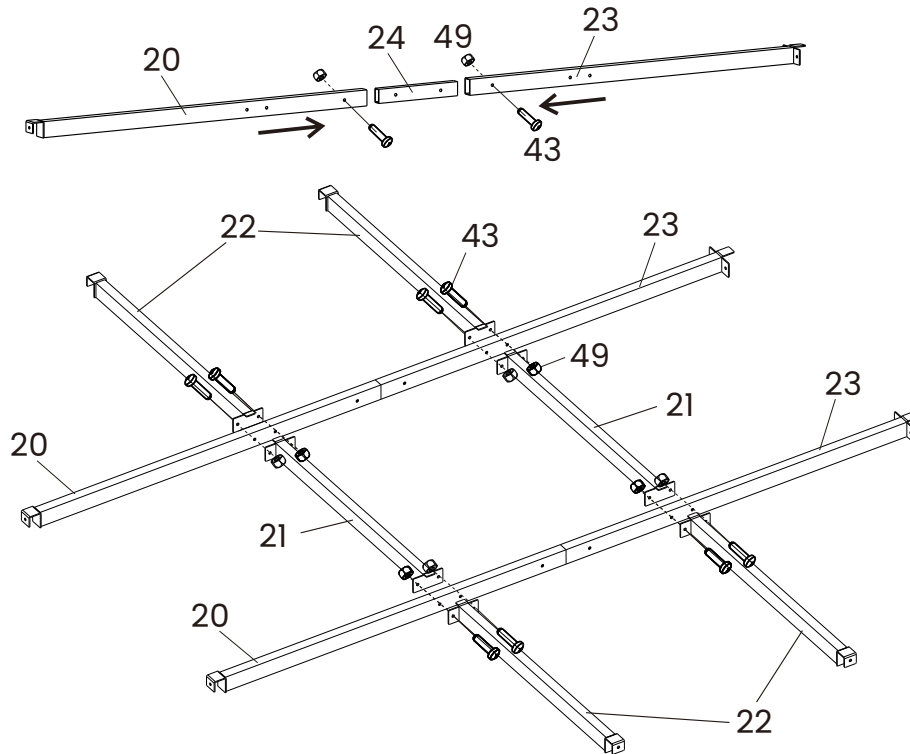

Step 12

- Fix the run support structure (assembled in Step 11) on top of the Run part as shown in the diagram by Screws #53.

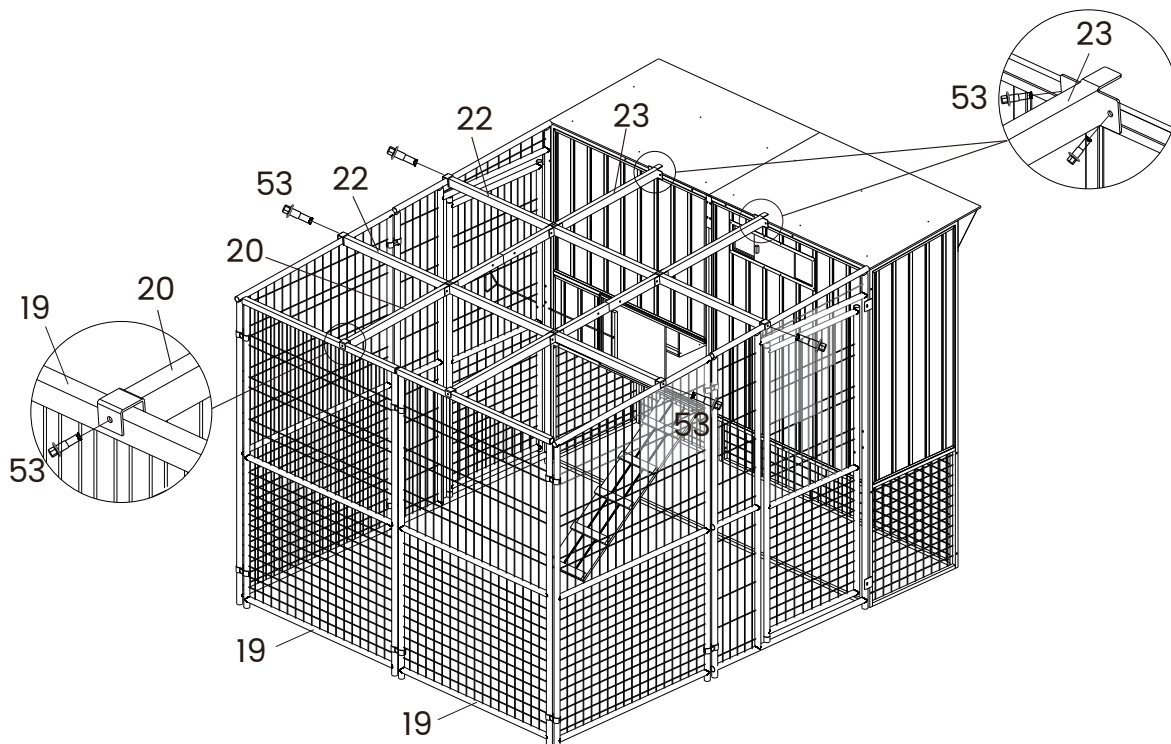

Step 13

- Assemble 3 pieces of Roof Panel #31 by #53.

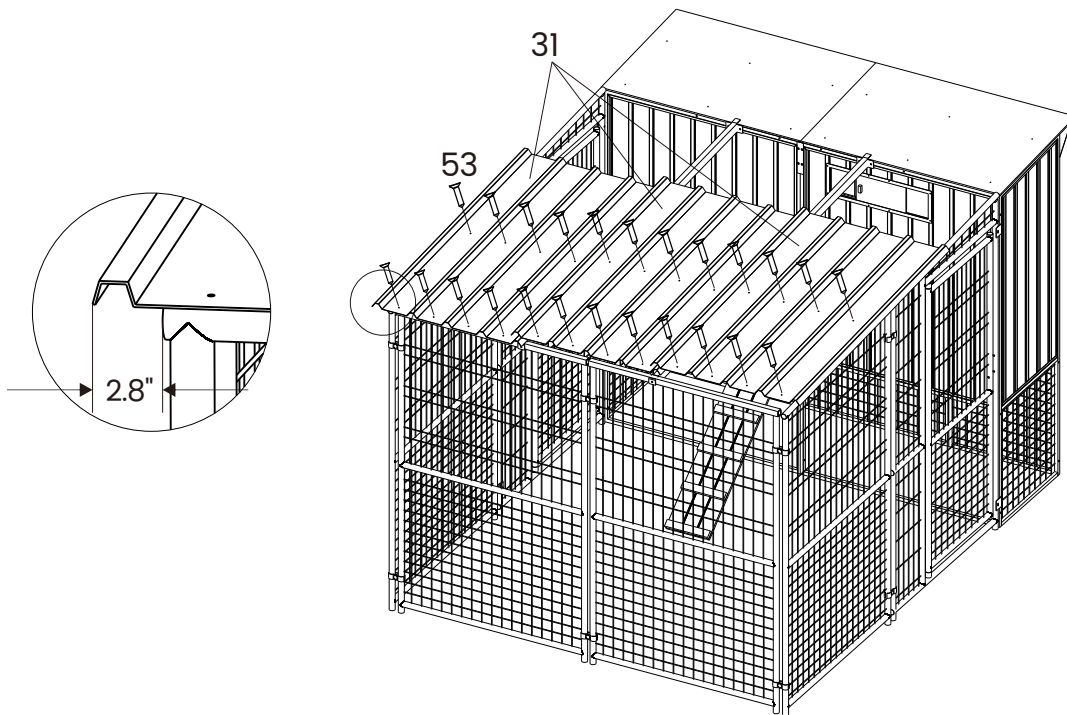

Step 14

- Assemble 3 pieces of Roof Panel #32 by Screws #50 & #53.
- Place 2 pieces of #14 (Long Roosting Bar-2) in the appropriate positions on the mesh, then hang #39 (Hanging Hook) on the mesh and secure it to #14 by Screws #50.

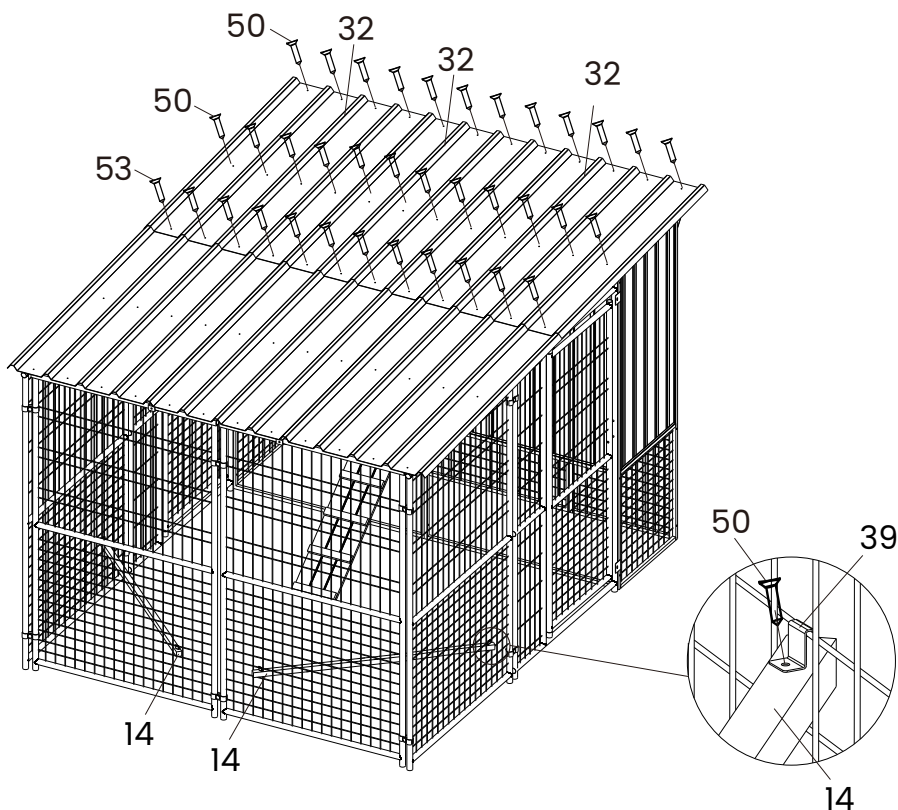

Step 15

- Install the Eaves #33, #34 by #50 through the pre-drilled holes.
- Install three #54 (T-handle Lock) at the designated door lock location of the panels #4, #1 and #5.

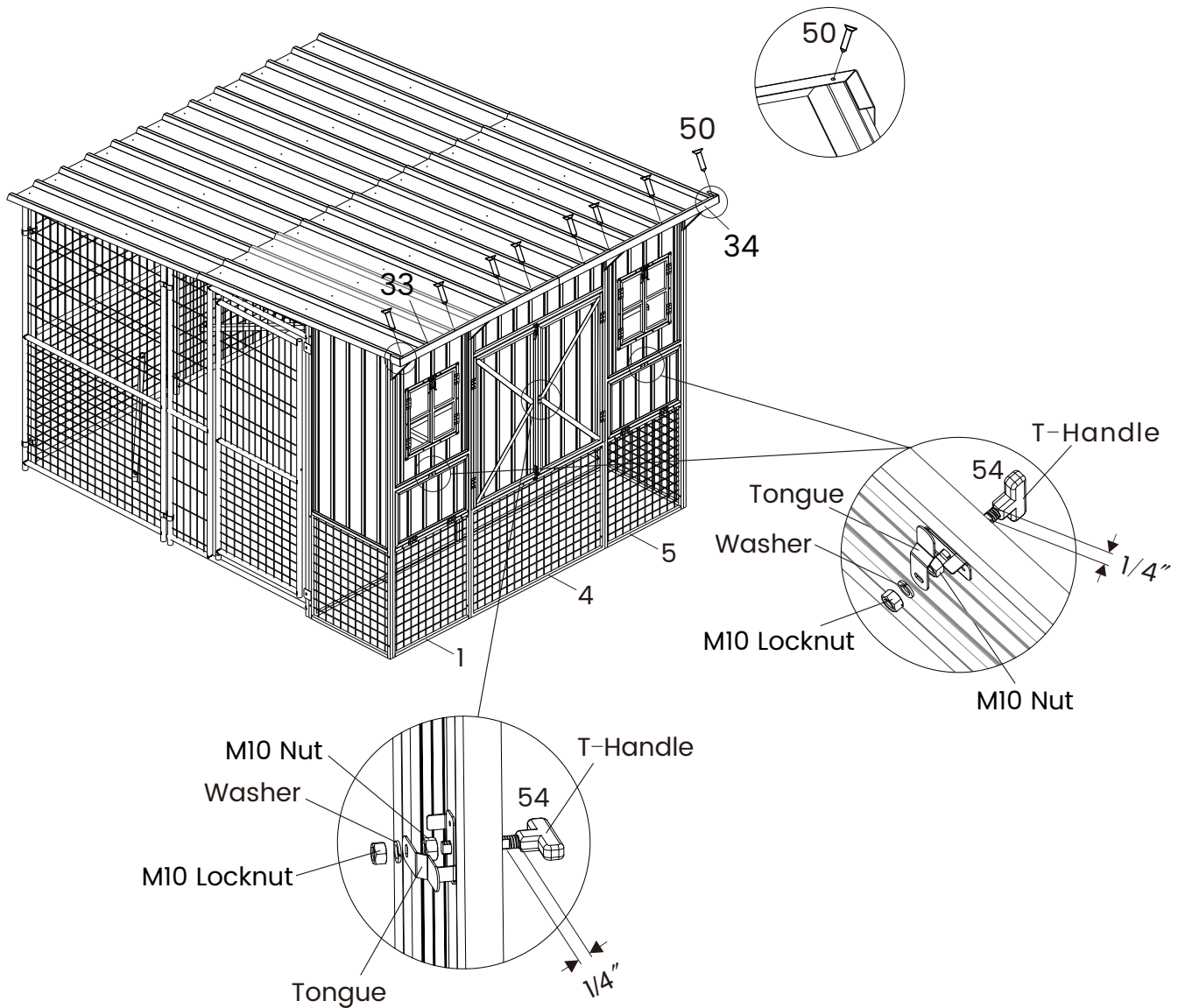

T-Handle Lock Assembly:

- Insert T-handle shaft into the pre-drilled hole on the wood panel, leaving 1/4" space outside. Tighten the M10 nut (not the Locknut) from the back of the panel, then put the Tongue in, make sure the tongue is in the same direction of the T-handle, fix the washer and M10 Locknut and tighten them.
- Push first before you turn the T-handle.

The entire assembly is now completed.