

Installation Guide for CoolTops Universal Tractor Canopy with Fan C4351B

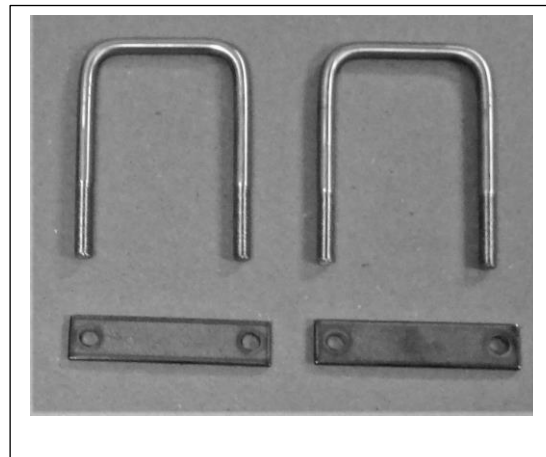

Universal Cage Hardware Kit will mount to both 2"x2" and 3"x2" ROPS.

- 1- Universal Fan Cage
- 1- Crossbar
- 2- Rubber bushings
- 2- 3"x5" Square U Bolts
- 2- 3" Steel Straps
- 2- 2"x5" Square U Bolts
- 2- 2" Steel Straps
- 4- 3/8-16 Lock Nuts

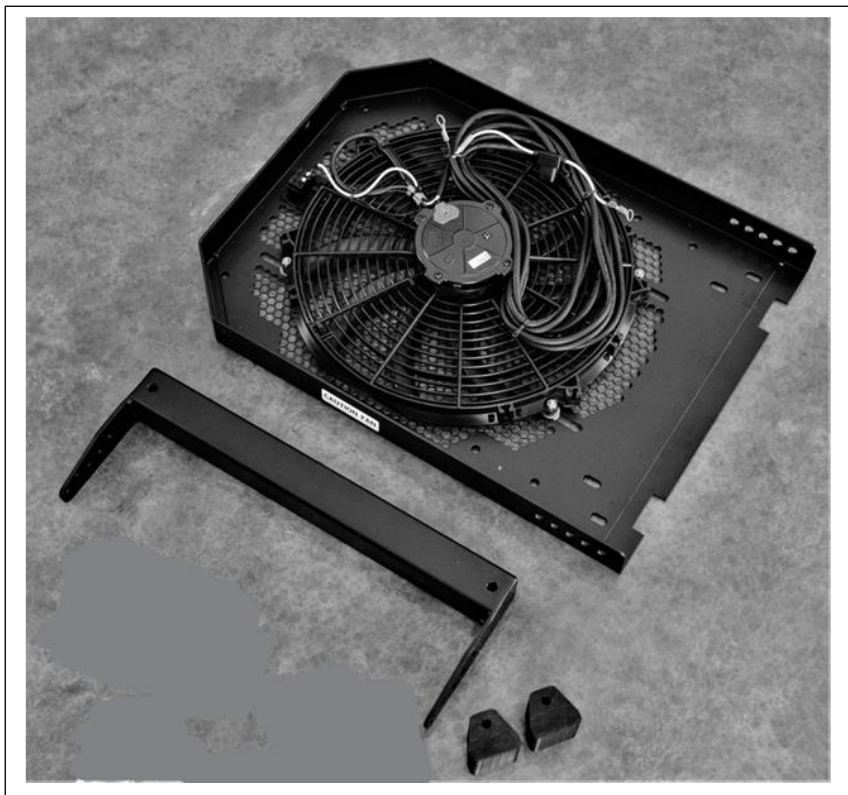
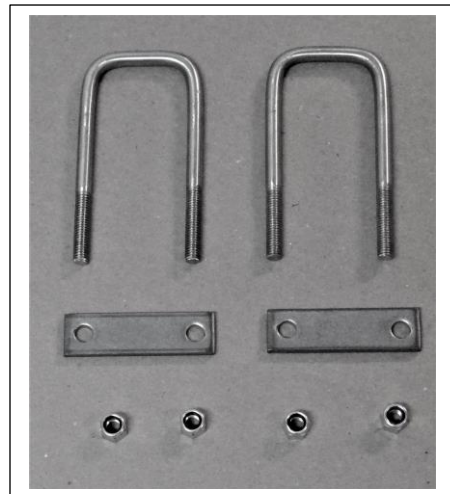

Cool Top Universal Cage

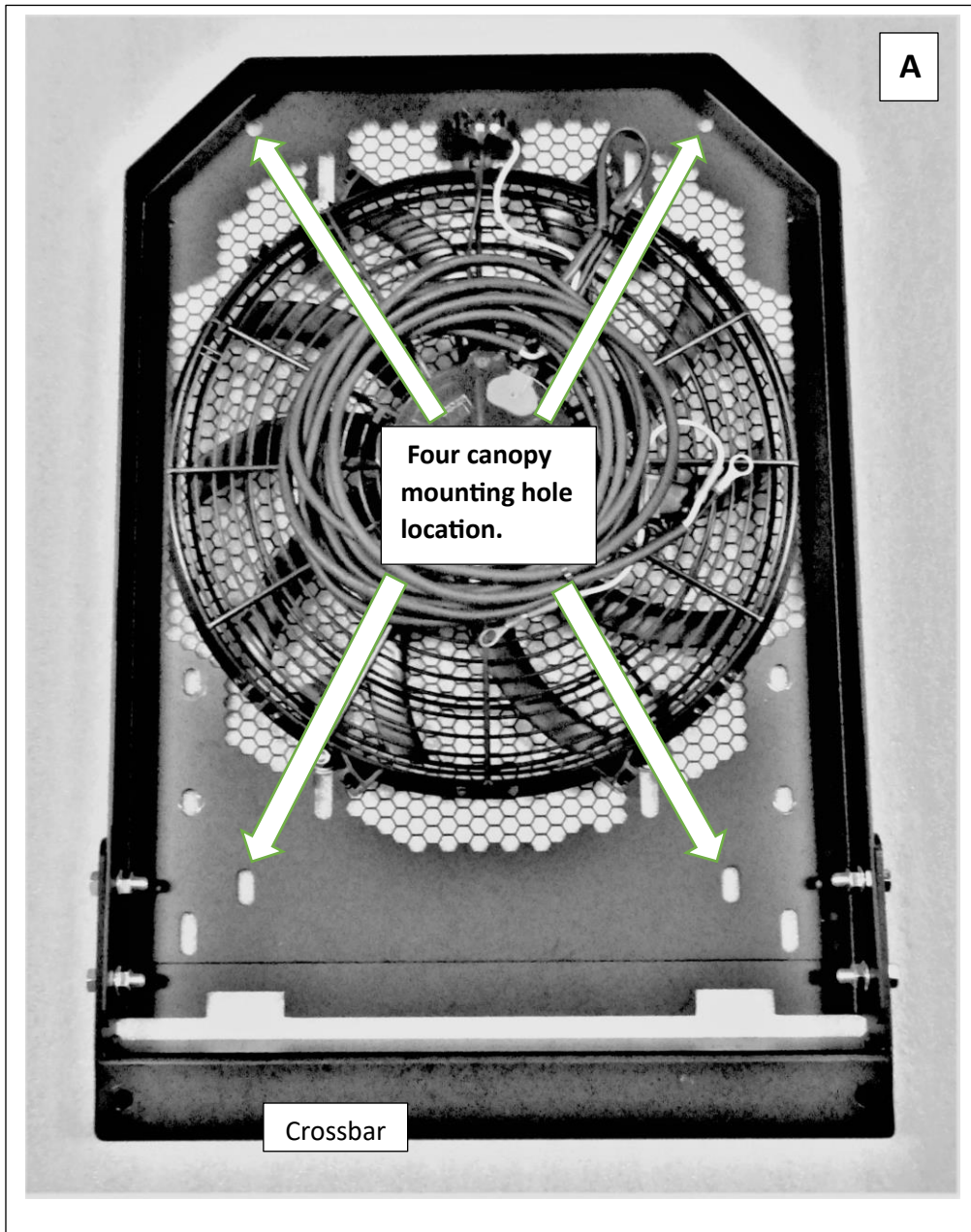

Crossbar setting for rear leaning ROPS.



Crossbar Setting for Forward Leaning ROPS.

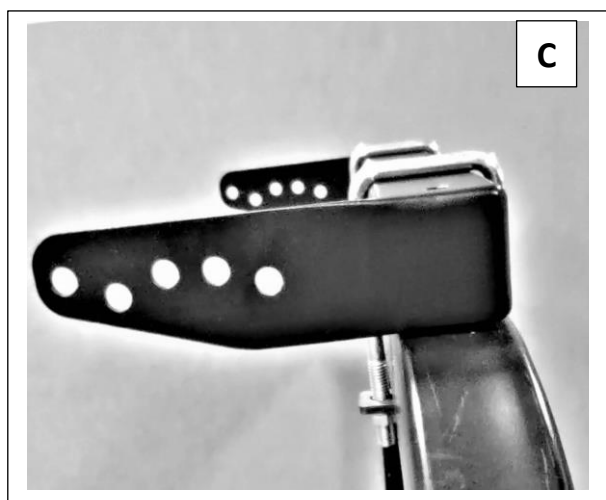

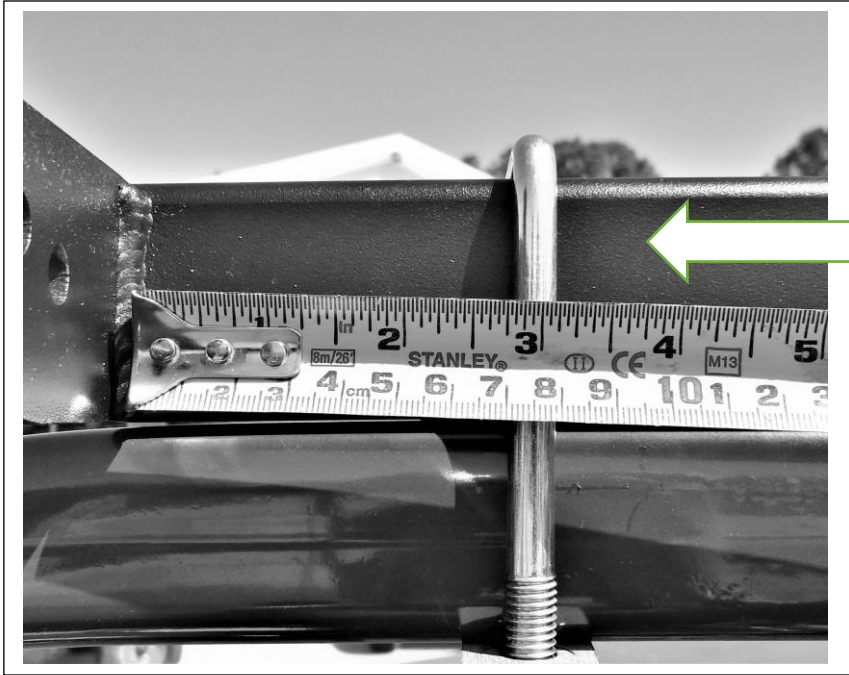

Before mounting the crossbar measure 3" from the inner wall of the crossbar to locate U Bolts.



For mounting on a 2"x2" rollover bar use,
 2- 2"x 5" Square U Bolts,
 2- 2" Steel Straps,
 4- 3/8-16 Lock Nuts to
 Position the Crossbar for pitch of the
 Rollover bar as illustrated in pictures B
 and C.

For mounting on a 3"x2" rollover bar use,
 2- 3"x 5" Square U Bolts,
 2- Rubber bushings,
 2- 3" Steel Straps,
 4- 3/8-16 Lock Nuts to
 Mount the crossbar flush to the front as
 illustrated.
 Position the Crossbar for pitch of the rollover
 bar as illustrated in pictures B and C.
 Rubber bushing is mounted as seen in the
 picture.

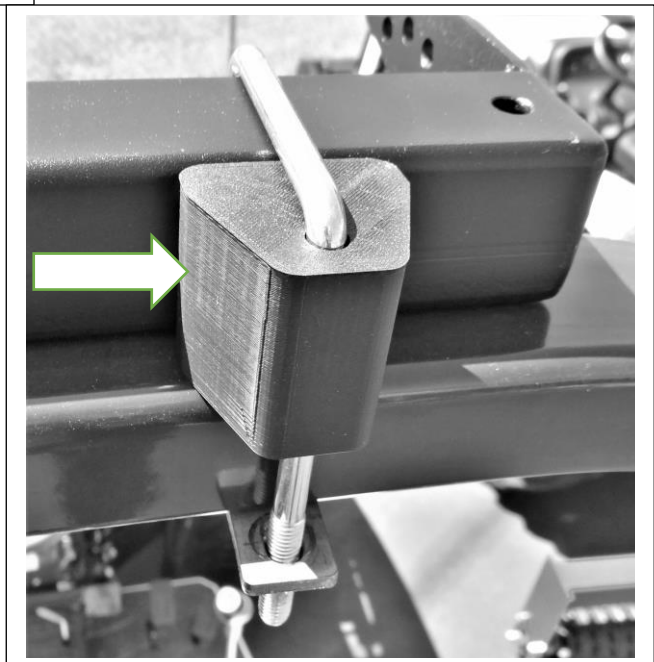

Mounting Fan Cage to Cross Bar



Cage Mounting Hardware

4- 3/8" lock nuts

4- 3/8" split lock washers

4- 3/8"-16 x 1" Shoulder Bolts

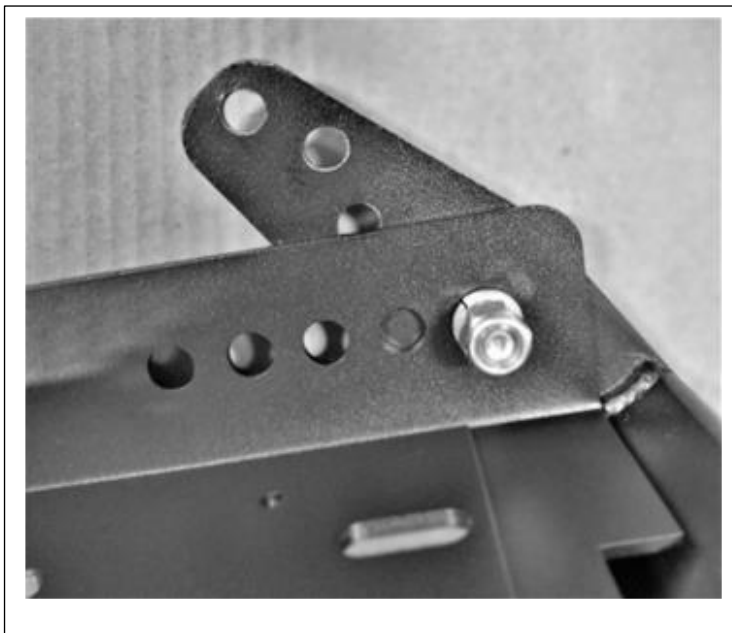

Mounting cage to the crossbar.

1 First mount cage at the pivot location shown, insert 3/8" bolt from the outside in, then fasten the split washer and lock nut.

Do not tighten yet.

2 Then adjust the cage to the level position for your rollover bar. Insert second bolt the same as the first.

You may have to hold the cage in place while tightening all the bolts.

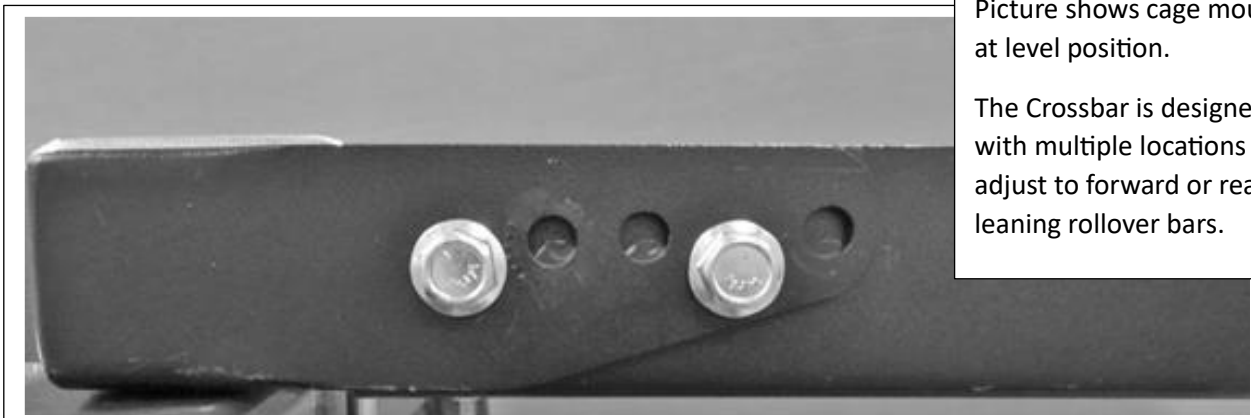

Picture shows cage mounted at level position.

The Crossbar is designed with multiple locations to adjust to forward or rear leaning rollover bars.

Connecting the Electrical Cord



Fan Cage comes prewired ready to hook to the battery.

1. Snip the cable ties holding the cord. Feed the cord between the cage and the crossbar.
2. Using the cable ties strap the electrical cord to the upper part of the rollover bar then follow it down to the equipment frame or along the electrical harness till you reach the Battery.
3. The white wire with the fuse box will hook to the positive terminal, and the other wire to the negative terminal.

Option: Two butt connectors have been provided if installer wishes to shorten the cable.

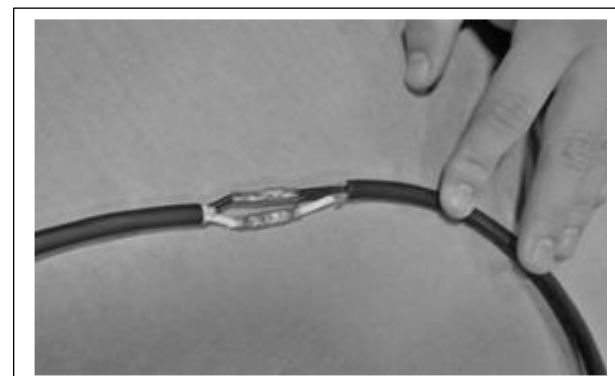
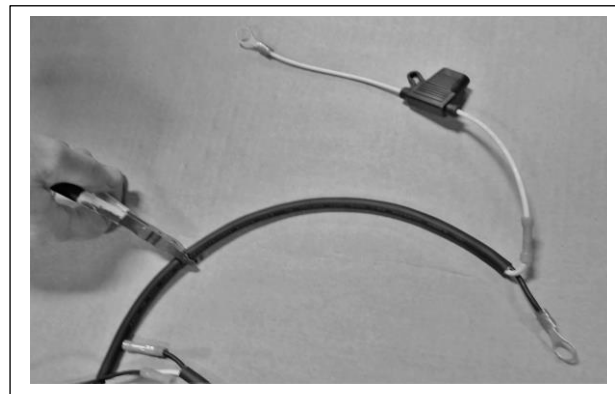

Mounting Canopy and Rain Cover (The front of the canopy has yellow reflectors.)

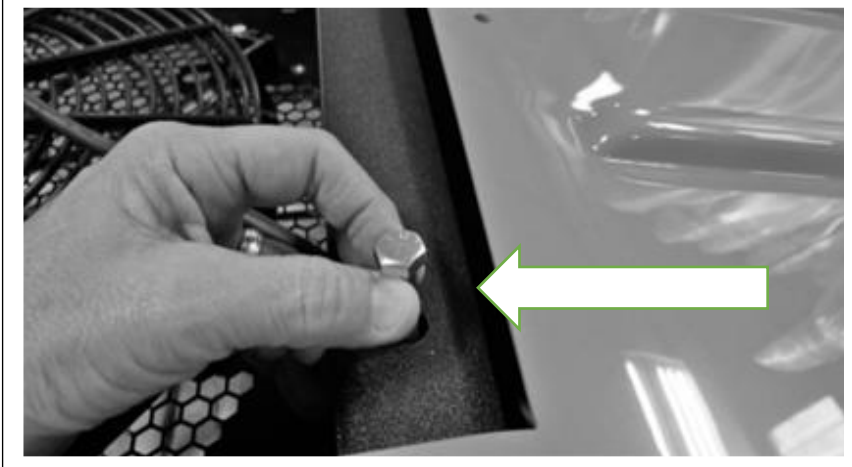

4- 3/8" – 16 x 3" Bolts
4- 3/8" Flat Washers
4- 3/8"-16 Locknuts
6- 1/4-20 x 3/4" Bolts
6- Seal Washers
6- 1/4-20 Locknuts

Reference picture **A** on first page for canopy hole location.

Using 4- 3/8" – 16 x 3" Bolts, 4- 3/8" Flat Washers, and 4- 3/8"-16 Locknuts, mount canopy through the predrilled canopy bars through into cage screen holes as seen in picture.

Before tightening make sure the bolts are straight and vertical.

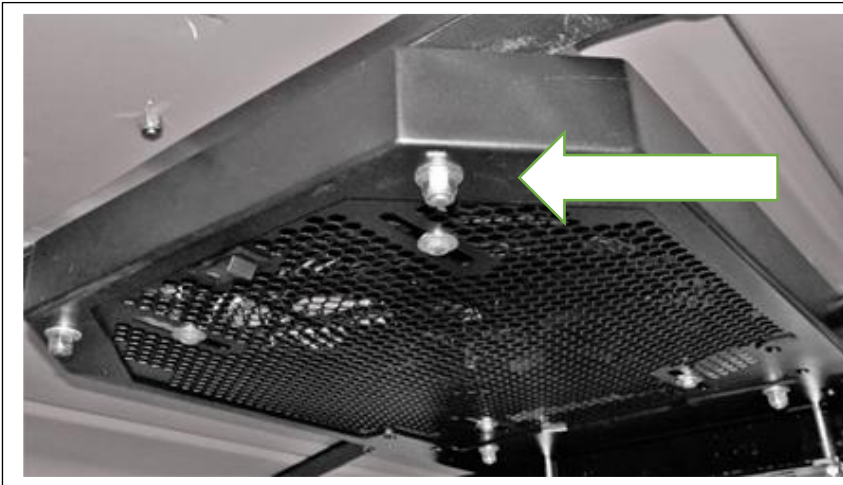

Install Rain Cover:

Using the 6- 1/4-20 x 3/4" Bolts, 6- Seal Washers, and 6- 1/4-20 Locknuts mount the canopy rain cover.

Sealed washers go on top side and of the canopy.

Mount taller end of rain cover to the rear so it will slant forward.

Use hand tools to tighten.

