

INSTALLATION AND USER INSTRUCTIONS

The Little Red Barn

Foldable Chick Brooder

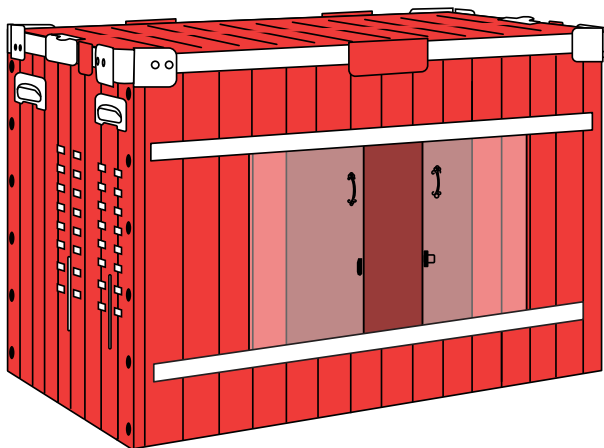

BR-CHICK-SET
PL-CHIK-BROD
November 2023
REV 23.01

TABLE OF CONTENTS

- 3 Package contents
- 4 How to Assemble
- 8 Accessories
- 10 Feed-port Position Recommendations

PACKAGE CONTENTS

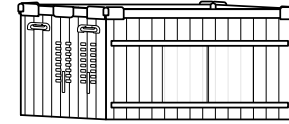

1x brooder

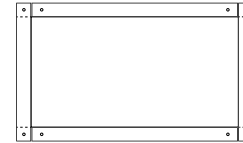

1x floor



4x plastic screws
and screw posts

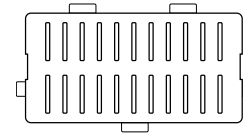

1x lid



1x jute pad



1x stickers

HOW TO ASSEMBLE

1. Assemble the tray.

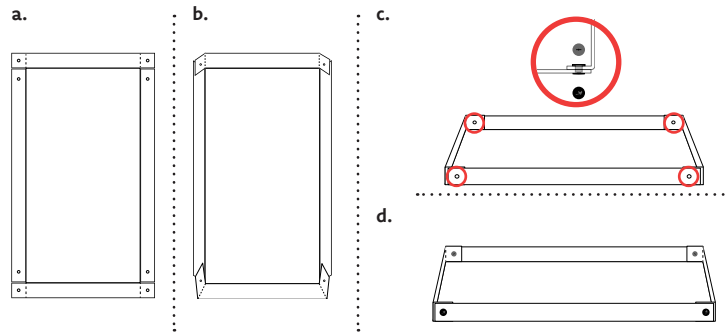

3. Push the bottom flap down until it lays flat.

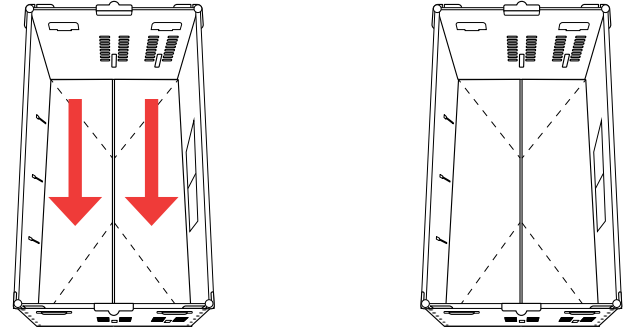

2. Gently open the brooder.

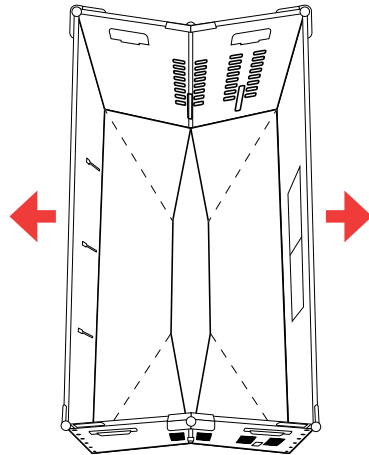

4

4. Lay the assembled tray inside the brooder.

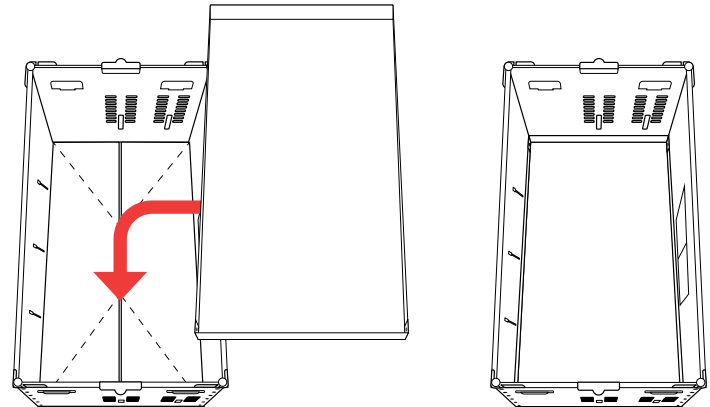

5

5. Add your jute pad and/or bedding and accessories. Your chicks will need a heat plate, feeder, and waterer. (Accessories are included in the Little Red Barn Sets and are also sold separately).

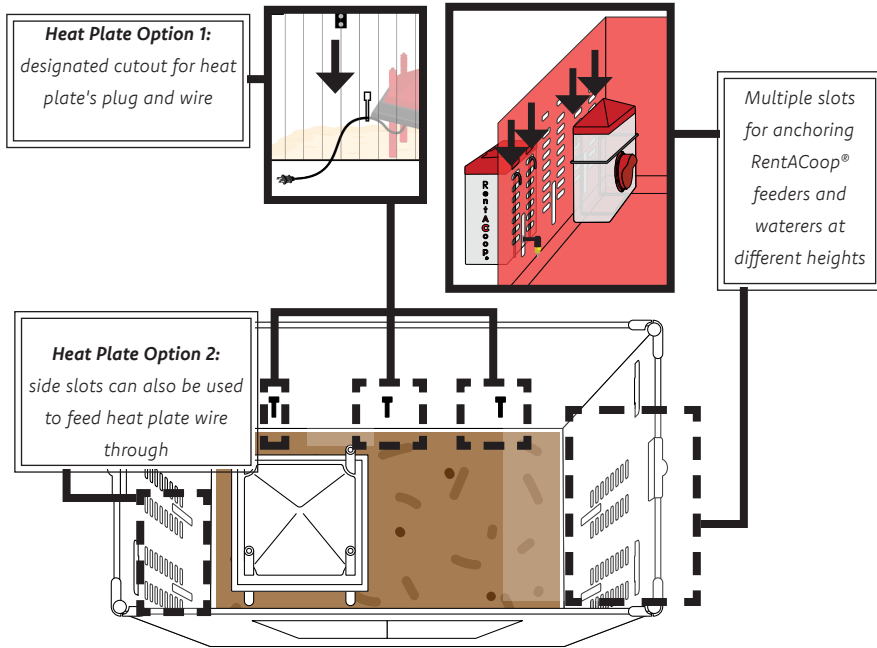

6. Place the lid on making sure to line up the lid's 5 velcro straps with the 5 corresponding velcro panels on the brooder and press to secure.

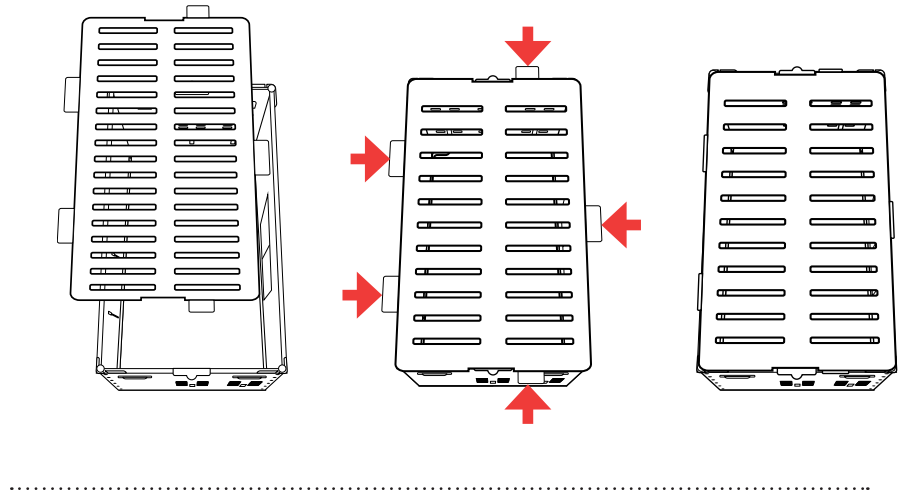

7. Decorate your brooder with the included stickers.

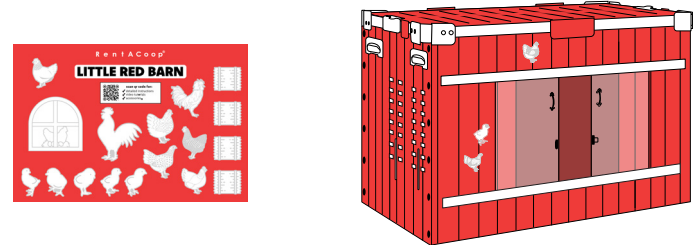

ACCESSORIES

These accessories are only included in the Little Red Barn Brooder Set. Otherwise, these accessories can be purchased separately.

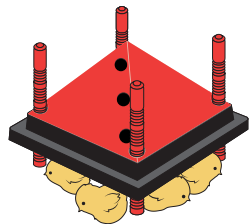

RentACoop® Heat Plate (10x10") Set

A resourceful and safer alternative to a heat lamp. Less of a fire risk! 10x10" Heating Plate warms up to 15 chicks. Uses only 15 watts/hr versus up to 100 watts used by a heat lamp. Anti-Roost Cone keeps heating plate clean.



RentACoop® Jute Brooder Pads

Our chick brooder pads are made of quality natural jute fiber, which is thick but not rigid. They are environmentally friendly and provide a healthy and comfortable environment for chicks.

Refills available on Amazon (sold in packs of 4)



RentACoop® Chick2Chicken 2.5LB Single-Port Feeder
Keep all your crumble, scratch, grain, pellets, and even oyster shell inside this weatherproof feeder while keeping dirt and water out! No more wasted food on the ground with this port design!



RentACoop® Versatile Drinker (64oz)

Waterer easily attaches to outside of cage. Flip-cap cover on waterer allows for easy refill; just fill from the top! Water level is viewable from the outside through the plastic. No need to remove waterer from brooder.

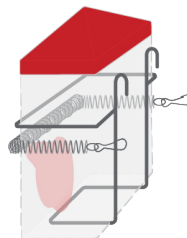

RentACoop® Wire Holder

Attach any of our 64oz drinkers or 2.5lb feeders to the inside or the outside of your brooder using this wire holder.

FEED-PORT POSITION RECOMMENDATIONS

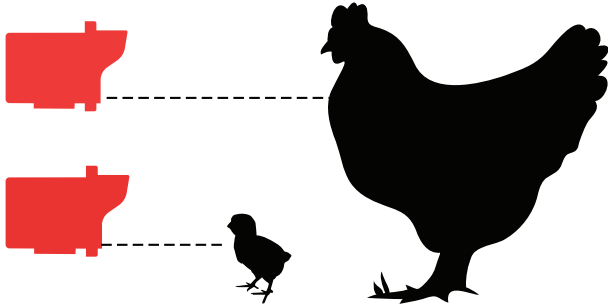

The appropriate height for the feeder is when the bottom of the port opening is shoulder-level with your shortest chick[en].





RentACoop®

QUESTIONS?

CONTACT OUR
EGG - S P E R T S

info@rentacoop.com

1 800-642-3571

M-F 9-5 EST



@rentacoop
#rentacoop