

## NOTICE

- \* Please make sure that you have all parts indicated and they are in good condition before you begin assembly of this item. Refer to part list and hardware list below for guidance.
- \* This item should be assembled on a soft surface to prevent scratching the finish during assembly.
- \* This item may require periodic tightening.
- \* If you are having difficulty, our friendly Customer Care team is always here to help. Please email customersupport@safavieh.com

## PREPARATION









- \* Before beginning assembly of product, make sure all parts are present. Compare parts with part contents list and hardware contents list.
- \* If any part is missing or damaged, do not attempt to assemble the product.
- \* Estimated Assembly Time: 10 minutes.
- \* Tools Required for Assembly (included): Spanner

## CARE AND MAINTENANCE

### OUTDOOR FURNITURE CARE

Store outdoor furniture indoors or cover well when not in use. Remove wooden furniture from standing water. Dust regularly with small brush or vacuum. Spills should be taken care of immediately before they harden or stain with a slightly dampened sponge.

### Part List and Hardware List



PIECE	DESCRIPTION	PICTURE	QUANTITY
D1	middle panels		2x
D2	bottom panels		2x
E	Assemble bar		2x
F	Top decor panel		2x
G	Supporting bar		2x
H	Supporting bar with bolts		3x
I	Supporting bar with holes		1X
J	Ground Stake		4x

 **SAFAVIEH**  
O U T D O O R

Model#PAT5007

Product Dimensions:48"W x18.5 " D x84" H



HW1	M8 Nut		15x
HW2	M8 Bolt		12x
HW3	Spinner		1x

# PREPARATION

- \* Before beginning assembly of product, make sure all parts are present. Compare parts with part contents list and hardware contents list.
- \* If any part is missing or damaged, do not attempt to assemble the product.
- \* Estimated Assembly Time: 10 minutes.
- \* Tools Required for Assembly (included): Spanner
- \* If you are having difficulty, our friendly Customer Care team is always here to help. Please email [customersupport@safavieh.com](mailto:customersupport@safavieh.com)

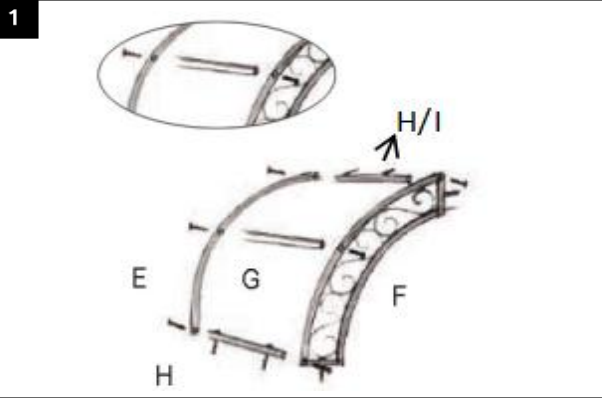

### step1: Assemble Top Frame

Connect Supporting Bars (G & H) to the Assembly Bar (E) and Top Decorative Panel (F) using the provided M8 nuts and spanner. Repeat for the other half of the top frame, replacing H with I (Supporting Bar with Holes).

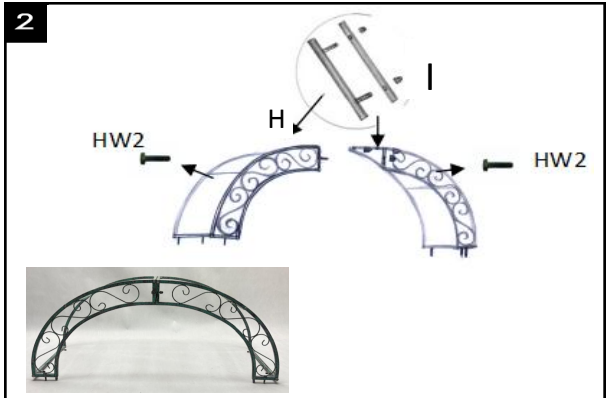

### step2: Secure Top Head

Assemble the top head section using M8 nuts.

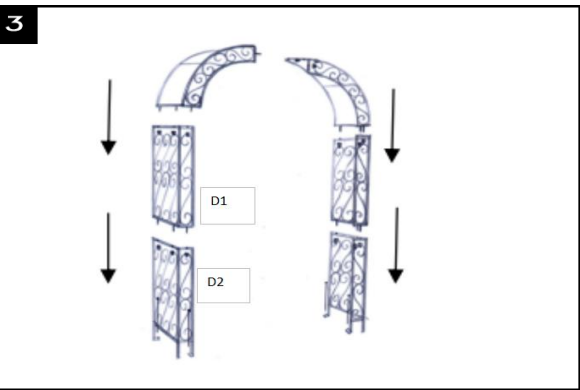

### step3: Assemble Side Panels

Connect Middle Panels (D1) and Bottom Panels (D2) together. Insert the top bar into the side panels using the provided nuts. Make side panels (D1&D2) together.

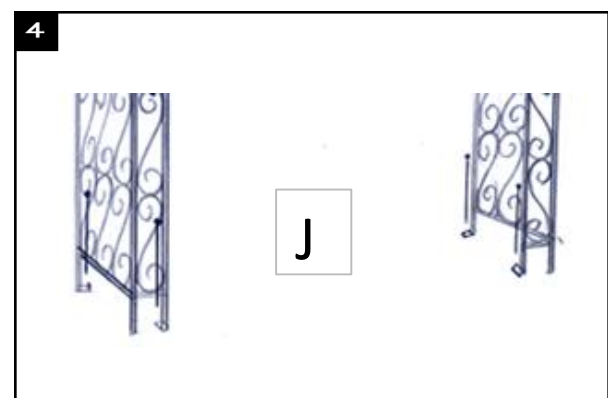

### step4: Reinforce the Arch

Hammer Ground Stakes (J) into the ground to secure and reinforce the arch.