

WoodMaxx

Power Equipment Ltd.



FM-54 PTO FLAIL MOWER OPERATOR'S MANUAL

INTRODUCTION

CONGRATULATIONS! You have just purchased a **WoodMaxx™ FM-54 Flail Mower**. This implement has been designed with care and built by skilled workers using the highest quality materials. We have compiled this owner's manual to help you understand and appreciate your flail mower. By taking a few minutes to read this manual and understand the maintenance instructions, it will give you better performance and extend the life of your mower. You must read this manual before operating the mower.

Using This Manual

This Operator's Manual is designed to help familiarize you with safety, assembly, operation, adjustments, troubleshooting, and maintenance. Read this manual and follow the recommendations to help ensure safe and efficient operation.

The information contained within this manual was current at the time of printing. Some parts may change slightly to assure you of the best performance. To check for updates refer to our website at www.WoodMaxx.com or call **1-855-966-3629** to speak to one of our representatives.

Owner Assistance

If customer service or repair parts are required please contact **WoodMaxx** at **1-855-966-3629**. WoodMaxx has trained personnel, repair parts and equipment needed to service this machine. The parts on your machine have been specially designed and should only be replaced with genuine WoodMaxx parts. Please reference your order number or serial number when calling.

Terminology

"Right" or "Left" as used in this manual is determined by facing the direction the machine will operate while in use unless otherwise stated.

Definitions

- **NOTE:** special point of information that the operator must be aware of before continuing.
- **IMPORTANT:** special point of information related to its preceding topic. The intention is that this information should be read and noted before continuing.

Safety Information	2
Driveline Safety Information	4
Machine Operation	5
Maintenance and Storage	7
Torque Specifications	11
Safety Labels	12
Troubleshooting	14
Technical Specifications	15
Parts & Diagrams	16
Warranty	32

All content in this manual; pictures, and text are the sole property of **WoodMaxx™ Power Equipment Ltd.** © 2013-23. No unauthorized reproduction.

SAFETY INFORMATION

General Safety Information

Thoroughly read and understand the instructions given in this manual before operation. Refer to the safety decals in the back of this manual. Read all instructions noted on them.

Do not allow anyone to operate this equipment who has not fully read and comprehended this manual and who has not been properly trained in the safe operation of the equipment.

- Operator should be familiar with all functions of the unit.
- Make sure all guards and shields are in place and secured before operating the equipment
- Watch out for wires, trees, etc., when raising and moving implement. Make sure all persons are clear of working area.
- Visually inspect the mower thoroughly before applying power; ensure the rotor is free of entangled material!
- Adult bystanders must be at least 150 feet from the mower during operation
- Children should NEVER operate or be near the mower during operation.
- Make sure the PTO shaft does not come apart or bottom-out during the normal lifting range. Damage resulting from an improperly sized PTO shaft is not covered under warranty.
- It is NOT recommended to operate the mower in temperatures below freezing and/or over top of frozen ground. Hardened steel (as used on cutting blades) can become brittle in temperatures below freezing and may result in breakage.
- Do not attempt alterations, repairs, or adjustments while the rotor is turning. Always disconnect the PTO, stop the tractor's motor, and put the keys in your pocket prior to attempting any alterations, repairs, or adjustments.
- Never leave the mower running unattended.
- Keep hands, feet, clothing, and other extremities away from all power-driven parts. Wear snug fitting clothing to avoid entanglement with moving parts.
- Riders obstruct the operator's view, they could be struck by foreign objects or thrown from the machine

Use Safety Lights and Devices

- Slow moving tractors, self-propelled equipment, and attached implements can create a hazard when driven on public roads. They are difficult to see, especially at night.
- Flashing warning lights and turn signals are recommended whenever driving on public roads. Use lights and devices provided with implement.

Transport Machinery Safely

- Comply with state and local laws.
- Maximum transport speed for any WoodMaxx implement is 20 mph on paved surface and 10 mph maximum on unpaved surface. Do not exceed. Never travel at a speed which does not allow adequate control of steering and stopping. Rough terrain requires a slower speed. Traveling at excessive speed on rough terrain that causes violent shaking or bouncing of the implement will damage the attachment point on the implement and/or the tractor. This type of damage is not covered under warranty.

SAFETY INFORMATION

Practice Safe Maintenance

- Understand procedure before doing work. Use proper tools and equipment. Refer to Operator's Manual for additional information.
- Work in a clean dry area.
- Lower the implement to the ground, put tractor in park, turn off engine, and remove key before performing maintenance.
- Allow implement to cool completely.
- Do not grease or oil implement while it is in operation.

Prepare for Emergencies

- Be prepared if a fire starts. Keep a fire extinguisher handy!
- Keep a first aid kit nearby.

Avoid High Pressure Fluids Hazard

- Before applying power to the mower, visually inspect all hydraulic components for damage or leaks. DO NOT apply power if there is evidence of either which may compromise operators' safety.
 - Always wear safety glasses and work gloves when working around hydraulic systems and especially when searching for high pressure leaks.
 - If a leak is encountered, use cardboard or a piece of wood as a shield to isolate and suppress a high-pressure leak. NEVER use your hands or any other body parts to contain a leak.
 - If skin is punctured by a high-pressure stream of hydraulic oil, seek medical help immediately. Serious infections and/or reactions can develop quickly.
- Avoid the hazard by relieving pressure before disconnecting hydraulic lines.
- Be mindful of lengthy hoses coupling equipment together as these create a trip hazard and entanglement area.

Wear Protective Equipment

- Wear protective clothing and equipment appropriate for the job.
- Avoid loose fitting clothing.
- Prolonged exposure to loud machinery noise can cause hearing impairment or hearing loss. Wear suitable hearing protection such as earmuffs or earplugs.
- This mower requires the full attention of the operator. Avoid wearing radio headphones while operating.

Protective Gear Required:

- Wrap around safety glasses
- Ear plugs
- Leather gloves
- Steel-toe work boots
- Heavy pants
- Long sleeved shirt

DRIVELINE SAFETY

All driveline manufacturers strive to produce a safe product. Drivelines, like most other components, must be used properly, including the use of proper tractor master shields and implement input connection shield. Please contact us if you have any questions about your driveline application.

- ✓ A person may become entangled in a rotating driveline which can cause serious injury or death. Stay abundantly clear of ALL rotating driveline components.
- ✓ NEVER operate an implement with driveline guards missing or damaged.
- ✓ Make sure PTO shaft guarding rotates independently from the PTO shaft and can telescope freely.
- ✓ Never wear loose-fitting clothing around rotating drivelines.
- ✓ Shut off engine, wait for driveline to stop, and completely disengage PTO shaft before making any adjustments or repairs.
- ✓ Always disconnect PTO shaft from tractor when performing maintenance on implement
- ✓ Make sure driveshaft guard restraint chains on are properly connected to the tractor or implement.
- ✓ Check that all shear pins are correctly installed and in good working order before engaging PTO. Ensure proper replacement pins are readily available.
- ✓ Do NOT use PTO adapters:
 - These result in unguarded areas of the driveshaft and will also limit the telescoping mobility of the driveline.
 - Adapters can also cause the implement to operate at the wrong speed and compromise the overload devices!

Hazard Reduction

- ✓ Ensure a sufficient clearance zone for the operation of the driveline, to avoid damaging the shielding components.

Some common areas of interference are:

- Three-point linkage.
- Extended or eye loop hitch pins.
- Hydraulic hoses.

A NOTE TO ALL USERS List of warnings and cautions cannot be all-inclusive. If situations occur that are not covered by this manual, the operator must apply common sense and operate this Flail Mower in a safe manner. If you have any questions, please contact **WoodMaxx** at **(855) 966-3629**.

MACHINE OPERATION

Operating Instructions

This is a flail mower NOT a rotary brush cutter. Flail mowers are designed to mow grass, weeds, and small saplings 1" in diameter or less. Attempting to mow material(s) beyond this will damage the mower and void the warranty.

Before each use, refer to the maintenance checklist on page 9. Ensure all items have been inspected and/or performed accordingly. Then, proceed to the following steps:

- Lower mower to ground and then slightly lift the draw arms upward to take the pressure off the front of the mower until the skid shoes are making minimal ground contact.
- Set tractor throttle to idle and engage the rear PTO. Slowly increase tractor throttle until 540 PTO RPM is achieved.
- Begin mowing an inconspicuous area at a slow forward speed carefully analyzing the mower's performance. If needed, adjustments to the mower can be made only when the PTO shaft is disconnected, and the tractor is off.
- Do not make sharp turns or attempt to back up while mower is on the ground.
- Never engage PTO with mower in the fully raised position or at full throttle.
- **DO NOT MOW IN REVERSE!** The front of the mower is the entrance, the rear is the discharge. Any attempt to use the mower contrary to this design will result in very poor performance and presents an increased chance of damaging the roller. (Damage caused to the mower as a direct result of mowing in reverse is not covered under warranty!)
- **DO NOT USE THE MOWER AS A PLOW!** Backing into areas of extreme overgrowth could present hidden obstacles, some of which could cause damage to the rear of the mower. Only use the mower as intended.
- Shutdown instructions:
 - o With the mower firmly on the ground, slowly bring tractor throttle back down to idle and then disengage PTO.
 - o Allow all rotating components to come to a complete stop before raising the mower or transporting the machine.

NOTE – It is normal to hear a “clanking” during the shutdown process. This noise is the cutting blades contacting the flails rotor shaft as they lose centrifugal momentum.

Transporting

NOTE – Always disengage PTO before raising mower to transport position (>24" off ground)

- Adjust and set the tractor's 3-point hitch lift height so that the driveline does not contact mower housing or tractor when mower is fully lifted.
- Be sure to reduce tractor ground speed when turning, leaving enough clearance so that the mower does not contact obstacles such as buildings, trees, or fences.
- Select a safe ground travel speed when transporting from one area to another. When traveling on roadways, transport in such a way that faster moving vehicles may pass safely.

MACHINE OPERATION



CAUTION

When traveling on public roads, whether at night or during the day, use accessory lights and devices for adequate warning to operators of other vehicles. Comply with all Federal, State, and local laws.

Mowing Tips

- Grass is best cut when it is dry. Mowing wet grass will hinder the mower's ability to cleanly discharge clippings and can result in undesired clumps of grass left behind the mower.
- Grass should be mowed frequently as shorter clippings deteriorate faster.
- If mowing extremely tall grass, it is best to raise cutting height and mow the area, then lower cutting height and mow a second time at the desired height.
- The mower is designed to be used at 540 PTO RPM. Lower RPM will not yield favorable performance results.
- Mowing speed should be altered to match the conditions and environment of the material being mowed. Always allow time for the mower to do its job.
- Keep the blades sharp. Just like a lawn mower, sharp blades perform with greater efficiency while reducing stresses on the mower.
- Slightly raise the mower when making sharp turns to prevent the skid shoes from penetrating into the soil.

3-Point Hitch Adjustments

- The 3-point hitch system on this mower has been designed for front to back flotation when mowing on uneven terrain. Adjust tractor's top center link to position the mower such that there is a 10-15° tilt from front to back. The back of the mower should be lower than the front.

Cutting Height Adjustments

The mower's cutting height depends on the position of the rear roller. While mowing, the rear roller should be contacting the ground at all times.

- With the mower gently resting on the ground, carefully remove the hardware that affixes both skid shoes to the mower body.
- Use the tractor's hitch to raise or lower the mower until the desired height level is achieved. Adjust both sides in equal amounts. Do not adjust the skid shoes to an angle (front to back). Only make parallel adjustments in reference to the ground.
- Replace hardware in respective locations and re-tighten. Use Loctite® 242 blue thread-locker to prevent loosening.

MAINTENANCE

Routine and proper servicing is key to overall longevity of any farm implement. With careful- and -systematic inspection, you can avoid costly maintenance, time, and repair.

Blade Replacement

The blades can be sharpened multiple times, however, eventually they will need total replacing. It is best practice to replace the blades as a complete set, however, partial blade replacement is also accepted.

- With the PTO shaft disconnected from the mower, tractor off, in park, and the key removed from ignition open the rear housing gate to gain access to the rotor and blades.
- Remove hardware securing the blades and discard used blades.
- Install new blades with new hardware:
 - o Start at the ends of the rotor and work inward.
 - o Installing each blade will be easier if the rotor is rotated 180° (or opposite) of the last installed blades to help maintain shaft balance. The rotor will be prone to rotating towards the side that has the greatest hanging mass.
 - o Tighten the blade hardware until the head of the bolt and the nut contact the mating mounting tabs. Never reuse blade hardware.

NOTE - Do not overtighten blade hardware as this may permanently deform the mounting tabs and not allow the blade to freely rotate.

- Close the rear housing gate and secure in place.

Drive Belt Maintenance

- Some mower models are equipped with an automatic belt tensioning system that requires minimal maintenance; periodically check to ensure that the tension arm pivots freely ensuring that positive pressure is being applied to the drive belts.
- A maximum belt deflection of 3/8" from 10 lbf (pound-force) will yield proper belt tension. If deflection is less than this, the belts are over tightened and may lead to premature failure of belt(s) and associated drive components. Adjust tension spring force until within spec.
- Changing the drive belts:

NOTE - Always install new drive belts as a complete set. Mixing new belts with old belts will exhibit differentiating belt tensions and will accelerate wear on the new belts, ultimately resulting in premature failure.

- o Remove belt guard fender and belt cover.
- o Disengage belt tension by loosening belt tension bolt until belts can be removed.
- o With tension relieved from the belts, remove old belts from pulleys.
- o Install new belts. Take care to ensure each belt is properly seated in the groove of the pulley.
- o Tighten belt tensioner bolt until proper belt tension is achieved.
- o Reinstall belt guard and belt guard fender.



CAUTION

For safety reasons, each maintenance operation must be performed with tractor PTO disengaged, mower lowered completely to ground and tractor engine shut off with ignition key removed.



CAUTION

Belt drive system under spring tension; use care to avoid bodily harm!

MAINTENANCE

PTO Slip Clutch Maintenance

At the beginning of each mowing season, to ensure proper functionality, the PTO clutch plates require burnishing. Burnishing is the process of intentionally allowing the engagement surfaces of the clutch plates to wear. When performed properly, burnishing cleans the clutch plate surfaces and will increase the start-up torque transmitted to the implement when the PTO is engaged.

- Determine the average torque spring deflection measurement and record this value to be used as reference at the end of this procedure.
- Loosen (but do not remove!) the torque spring hardware used to clamp the clutch pack together.

NOTE - Depending on the implement, each clutch pack will exhibit a unique slippage threshold. It may take several adjustments attempts to meet this requirement. Generally, once the springs lose contact with the flange yoke, slippage should occur.



WARNING

Rotating drivelines can cause serious injury or death. Refer to Driveline Safety Section for proper handling of driveline components before proceeding!

- With the clutch pack loosened and the tractor at idle, slowly engage with PTO and allow the driveshaft to slip for 5-10 seconds. Power should **NOT** be transmitted to the implement. If the implement begins to "start", further loosening of the clutch pack is required. Burnishing is complete after 1 successful cycle. (Multiple cycles are not needed)

NOTE - Burnishing may result in smoke and/or odor. This is normal.

- Retighten the torque spring bolts to the original recorded measured value. From this value, tighten each nut an additional $\frac{1}{2}$ - $\frac{3}{4}$ turns. This will account for the material that was removed from the clutch plates during the burnishing process. Further adjustments may be needed depending on mowing conditions.
- DO NOT grease the slip clutch assembly.



WARNING

Do not over-tighten the slip clutch or damage will occur!



GEARBOX OIL VOLUME

Use SAE 80W-90 Gear Oil or Amsoil Severe Gear 75W-90 Synthetic Gear Lube
(Available on our website) for best performance

FM-54 – 16 ounces









IMPORTANT: DO NOT OVERFILL! Mower should be level when checking oil in gearbox!

MAINTENANCE

Regular Maintenance Checklist

PROCEDURE	SERVICE DATES					
	Prior to First Use	After First 2 Hours of Use	Before Each Use	Every 10 Hours	Every 25 Hours	Every 200 Hours
Check Blades for Sharpness	✓		✓			
Check/Tighten Fasteners	✓	✓		✓		
Grease Bearings (See Bearing Lubrication Guide)						
Lubricate PTO Shaft Driveline	✓				✓	
Inspect Belts	✓				✓	
Check Gear Box Oil	✓				✓	
Change Gear Box Oil						✓
Check Safety Shields	✓		✓			

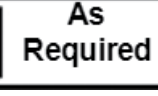
Lubrication

Area of Machine	Frequency	Lubricant to Use
PTO Shaft U-Joints	  25 Hours	Multi-Purpose Grease
Rolling Bearing (Both Ends)	 	See Bearing Lubrication Guide
Blade Axle Bearing (Both Ends)	 	See Bearing Lubrication Guide
Gearbox	  As Required	80W-90 Gear Oil or 75W-90 Synthetic SEE GEARBOX OIL VOLUME CHART
PTO Shaft Slides	  25 Hours	Multi-Purpose Grease

MAINTENANCE

Bearing Lubrication

There are many questions when it comes to greasing bearings. All WoodMaxx implements are now equipped with bearings that are factory greased so that 33% of the race is full of grease, this allows for operation at all speed ranges. In a clean, dry environment adding more grease to the bearing is not required for at least 500 hours of use. This is counter intuitive to many people that have older equipment and are used to pumping grease into the bearings daily. Modern high quality bearings are made from better steel alloys, provide higher tolerances, increased rubber seal compounds, and better quality lubricants. These recommendations are based on load, spindle speed, operating temperature, and environmental conditions. More grease is not better, rather is counterproductive and can cause the bearing to generate heat and lead to premature failure. You should never pump grease into a bearing until the seals push outward, this is a sign that too much grease is applied, and can deform the seal causing an entryway for contaminants. Follow the bearing lubrication schedule below for optimum performance and long bearing life.

- **BEARINGS** - All bearings have been factory greased. Refer to the **Bearing Lubrication Guide** below for recommended lubrication intervals.
- **PTO SHAFT** - grease the two grease zerks on the universals every 10 hours of use with a high quality multi-purpose grease.
- **OIL RESERVOIR** - Fill the gearbox with the recommended amount of oil in the chart below. Failure to do so will cause damage to the gearbox which may result in failure.

Bearing Lubrication Guide Based on Environmental Conditions

Machine stored and operated in clean, dry environment.	2-pump shots of grease after 500 hours	2" shaft or larger
	1-pump shot of grease after 500 hours	3/4" - 2" shaft
Machine stored and operated in dirty, dusty environment.	2-pump shot of grease after 250 hours	2" - shaft or larger
	1-pump shot of grease after 250 hours	3/4" - 2" shaft
Machine stored and operated in wet environment.	1-pump shot of grease after 50 hours	3/4" - shaft or larger

Storage

At the end of the working season or when the mower will not be used for a long period, it is good practice to clean off any dirt, grass or grease that may have accumulated on the mower and any of the moving parts.

- Detach and store implements in an area where children normally do not play. Secure implement by using blocks and supports.
- Store unit inside, if possible, for longer life. Alternatively, cover with a tarp to reduce exposure and prevent weather damage.
- Apply an anti-rust/petroleum-based lubricant to the guide rails to prevent rust. 3-in-1® or WD-40® spray oil is a good choice.
- Clean as necessary.
- Check blades for wear and replace if necessary.

TORQUE SPECIFICATIONS

Torque Specifications

The tables shown below give the correct torque values for various bolts and cap screws. Tighten all bolts to the torques specified unless otherwise noted. Check tightness of bolts periodically, using bolt torque chart as a guide. Replace hardware with the same length and grade of bolt.

Torque Values Chart for Common Bolt Sizes													
Bolt Size (Inches)	Bolt Head Identification						Bolt Size (Metric)	Bolt Head Identification					
	Grade 2		Grade 5		Grade 8			Class 5.8		Class 8.8		Class 10.9	
in-tpi ¹	N·m ²	ft-lb ³	N·m	ft-lb	N·m	ft-lb	mm x pitch ⁴	N·m	ft-lb	N·m	ft-lb	N·m	ft-lb
1/4" - 20	7.4	5.6	11	8	16	12	M 5 X 0.8	4	3	6	5	9	7
1/4" - 28	8.5	6	13	10	18	14	M 6 X 1	7	5	11	8	15	11
5/16" - 18	15	11	24	17	33	25	M 8 X 1.25	17	12	26	19	36	27
5/16" - 24	17	13	26	19	37	27	M 8 X 1	18	13	28	21	39	29
3/8" - 16	27	20	42	31	59	44	M10 X 1.5	33	24	52	39	72	53
3/8" - 24	31	22	47	35	67	49	M10 X 0.75	39	29	61	45	85	62
7/16" - 14	43	32	67	49	95	70	M12 X 1.75	58	42	91	67	125	93
7/16" - 20	49	36	75	55	105	78	M12 X 1.5	60	44	95	70	130	97
1/2" - 13	66	49	105	76	145	105	M12 X 1	90	66	105	77	145	105
1/2" - 20	75	55	115	85	165	120	M14 X 2	92	68	145	105	200	150
9/16" - 12	95	70	150	110	210	155	M14 X 1.5	99	73	155	115	215	160
9/16" - 18	105	79	165	120	235	170	M16 X 2	145	105	225	165	315	230
5/8" - 11	130	97	205	150	285	210	M16 X 1.5	155	115	240	180	335	245
5/8" - 18	150	110	230	170	325	240	M18 X 2.5	195	145	310	230	405	300
3/4" - 10	235	170	360	265	510	375	M18 X 1.5	220	165	350	260	485	355
3/4" - 16	260	190	405	295	570	420	M20 X 2.5	280	205	440	325	610	450
7/8" - 9	225	165	585	430	820	605	M20 X 1.5	310	230	650	480	900	665
7/8" - 14	250	185	640	475	905	670	M24 X 3	480	355	760	560	1050	780
1" - 8	340	250	875	645	1230	910	M24 X 2	525	390	830	610	1150	845
1" - 12	370	275	955	705	1350	995	M30 X 3.5	960	705	1510	1120	2100	1550
1-1/8" - 7	480	355	1080	795	1750	1290	M30 X 2	1060	785	1680	1240	2320	1710
1 1/8" - 12	540	395	1210	890	1960	1440	M36 X 3.5	1730	1270	2650	1950	3660	2700
1 1/4" - 7	680	500	1520	1120	2460	1820	M36 X 2	1880	1380	2960	2190	4100	3220
1 1/4" - 12	750	555	1680	1240	2730	2010							
1 3/8" - 6	890	655	1990	1470	3230	2380							
1 3/8" - 12	1010	745	2270	1670	3680	2710							
1 1/2" - 6	1180	870	2640	1950	4290	3160							
1 1/2" - 12	1330	980	2970	2190	4820	3560							

¹ in-tpi = nominal thread diameter in inches-threads per inch
² N·m = newton-meters
³ ft-lb = foot pounds
⁴ mm x pitch = nominal thread diameter in millimeters x thread pitch

Torque tolerance + 0%, -15% of torquing values. Unless otherwise specified use torque values listed above.

Torque figures indicated above are valid for non-greased or non-oiled threads and heads otherwise specified. Therefore, do not grease or oil bolts or cap screws unless otherwise specified in this manual. When using locking elements, increase torque values by 5%.

SAFETY LABELS

Safety Labels and Alert Symbols

The SAFETY ALERT SYMBOL indicates there is a potential hazard to personal safety involved and extra safety precaution must be taken. When you see this symbol, be alert and carefully read the message that follows it. In addition to design and configuration of equipment, hazard control and accident prevention are dependent upon the awareness, concern, prudence and proper training of personnel involved in the operation, transport, maintenance and storage of equipment.

- Keep all safety labels clean and legible.
- Replace all damaged or missing labels. To order new labels call **WoodMaxx Power Equipment Ltd.** at **855-966-3629**.



DANGER

This symbol indicates an imminently hazardous situation which, if not avoided, will result in death or serious injury. This signal word is limited to the most extreme situations, typically for machine components that, for functional purpose, cannot be guarded.



WARNING

This symbol indicates a potentially hazardous situation which, if not avoided, could result in death or serious injury, and includes hazards that are exposed when guards are removed. It may also be used to alert against unsafe practices.



CAUTION

This symbol indicates a potentially hazardous situation which, if not avoided, may result in minor or moderate injury. It may also be used to alert against unsafe practices.



FM-WRN-HITCH



FM-WRN-ROT



FM-DNG-BLADE

SAFETY LABELS

⚠ DANGER

ROTATING DRIVELINE HAZARD
:: KEEP AWAY ::



To Prevent Serious Injury or Death:

- Keep all guards in place when operating.
- Operate only at 540 RPM.
- Keep hands, feet, hair and clothing away from moving parts.
- Keep U-joint angles equal and as small as possible.
- Do not exceed driveline manufacturers recommended operating length.

DNG-DRIVELINE

DNG-DRIVELINE

⚠ WARNING

ENGAGE TRACTOR CLUTCH SLOWLY DURING START UP OR DAMAGE WILL OCCUR. KEEP PTO SHAFT WITHIN 25° OF LEVEL DURING OPERATION.

FM-WRN-CLUTCH

FM-WRN-DRIVE

⚠ WARNING

To Prevent Serious Injury or Death:

- Read and understand Operator's Manual before using.
- Do not permit riders on tractor or mower, including children.
- Do not allow children to operate mower.
- Operate only with guards installed and in good working condition.
- Operate only with tractor equipped with ROPS and seat belt.
- Use extra care when operating in rough terrain or when rocks or debris are present.
- Do not operate in the raised position.
- Stop engine, lower mower, set brake, and wait for all moving parts to stop before dismounting.
- Support mower securely before working beneath unit.
- Transport with clean reflectors, SMV, and working lights as required by law.
- Keep yourself, others, and clothing away from rotating PTO.
- Operate only at a safe distance from bystanders.
- Do not stand between tractor and mower.
- Be careful on uneven terrain. Decrease speed when turning.
- Locate underground utility lines before mowing.
- Do not exceed safe transport speed.

FM-WRN-MOW

FM-WRN-MOW

⚠ WARNING

HIGH PRESSURE FLUID HAZARD



To Prevent Serious Injury or Death:

- Relieve pressure on system before repairing or adjusting.
- Wear proper hand and eye protection when searching for leaks. Use wood or cardboard instead of hands.
- Keep all components in good repair.

FM-WRN-PRESS

FM-WRN-CLUTCH

⚠ WARNING

The PTO Driveline MUST be measured and cut (if required) as per the Owner's Manual. Failure to do so will result in damage to both the tractor and the implement.

FM-WRN-PRESS
(Hydraulic Models Only)

⚠ CAUTION Consult tractor Owner's Manual for proper engine RPM to achieve 540 RPM at rear PTO.

540 RPM ONLY

FM-CTN-540RPM

FM-CTN-540RPM

⚠ WARNING! **DO NOT MOW IN REVERSE OR DAMAGE WILL OCCUR TO YOUR MOWER!**

FM-DNG-REVERSE

⚠ DANGER! **STAY BACK 150 FEET AT ALL TIMES**

FM-DNG-150FT

TROUBLESHOOTING

PROBLEM	SOLUTION
Belt Slipping	<ul style="list-style-type: none"> • Unplug and clean mower deck • Remove belt guard shields and clean sheaves • Tighten belt tension spring • Replace Belts
Patches of Uncut Grass	<ul style="list-style-type: none"> • Mow at full throttle (540 PTO rpm), check PTO speed and tractor engine • Shift transmission to a lower gear/reduce tractor speed • Tighten belts • Replace missing blades
Excessive Vibration	<ul style="list-style-type: none"> • Replace blade - possible blade missing • Replace drive belts • Replace pulleys or align • Remove belt guard shields & clean debris from belt area & sheaves
Gearbox Noisy	<ul style="list-style-type: none"> • Check lubricant level
Blades Scalping Grass	<ul style="list-style-type: none"> • Raise cutting height by adjusting roller • Change mowing pattern • Reduce speed around turns • Make sure that front of mower is 15° higher than back of mower
Uneven Cut	<ul style="list-style-type: none"> • Shift to a lower gear • Level mower • Replace missing blades
Tractor Loaded Down by Mower	<ul style="list-style-type: none"> • Mow at full throttle (540 PTO rpm) • Shift to a lower gear. Reduce tractor speed • Clean mower • Sharpen blades • Tractor HP insufficient

TECHNICAL SPECIFICATIONS

WOODMAXX FM-54 FLAIL MOWER SPECIFICATIONS

PTO HP REQUIREMENT	18-40
PTO SPEED	540
GEAR BOX	CAST IRON WITH INTERNAL OVER RUNNING CLUTCH
CUTTING WIDTH	50 INCH
CUTTING HEIGHT	3/4 - 2.5 INCH
SIDE PLATE THICKNESS	3/16 INCH Q-235 STEEL
HYDRAULIC SIDE SHIFT	NO
SHIFTED LEFT (INCH)	N/A
SHIFTED RIGHT (INCH)	24" LEFT / 31" RIGHT
ROTOR RPM	2092 RPM
ROTOR TUBE DIAMETER	3 INCH
ROLLER DIAMETER	4-1/4 INCH
BLADE SPEED - F/S	97
SWING DIAMETER	10.75 INCH
DRIVE BELTS	(3) B-SERIES USA GATES "TRUFLEX"
HAMMER BLADE OPTION	18 INDIVIDUAL
Y-BLADES OPTION	18 SETS
3-PT HITCH	CAT-1 ONLY
PRODUCT DIMENSIONS	56"L x ___"W x ___"H
SHIPPING DIMENSIONS	58"L x 29"W x 27"H
PRODUCT WEIGHT	410 LBS.
SHIPPING WEIGHT	690 LBS.

PARTS & DIAGRAMS

FM-54 Flail Mower

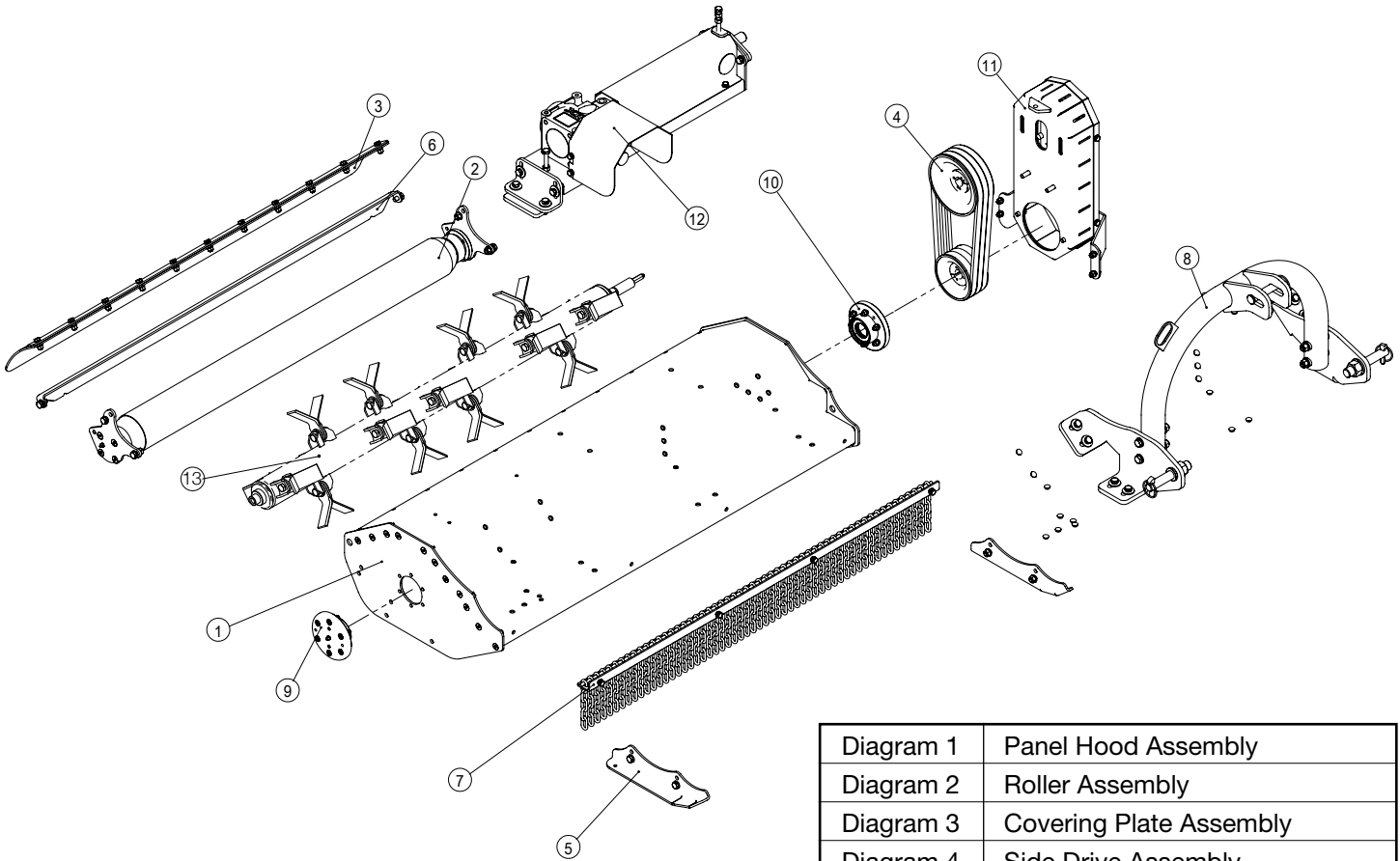

Diagram 1	Panel Hood Assembly
Diagram 2	Roller Assembly
Diagram 3	Covering Plate Assembly
Diagram 4	Side Drive Assembly
Diagram 5	Skid Plate Assembly
Diagram 6	Scraper Assembly
Diagram 7	Protective Assembly
Diagram 8	Hitch Assembly
Diagram 9	Bearing Seat Assembly
Diagram 10	Bearing Seat Assembly
Diagram 11	Side Cover Assembly
Diagram 12	Gearbox Drive Shaft Assembly
Diagram 13	Axle Assembly

**Content coming soon,
please call Woodmaxx
at 855-966-3629
for information**



LIMITED WARRANTY

WOODMAXX™ POWER EQUIPMENT, LTD. ("**WOODMAXX™**") warrants its products to the original retail purchaser as follows:

WARRANTY

WOODMAXX™ warrants MX-series, WM-series, chipper and sawmill parts only to be free from defects in material and workmanship for three (3) years from the date of original purchase except where otherwise noted. Backhoe, snow blower, tiller, flail mower, and DC-Chipper parts are warranted to be free from defects in material and workmanship for two (2) years from the date of original purchase except where otherwise noted. Electrical components are warranted for 60 days, beginning on the date of delivery. Hydraulic hoses are warranted for 30 days, beginning the date of delivery. PTO shafts are warranted for 90 days, beginning at the date of delivery. Proof of purchase (original receipt) is required. The exclusive remedy for this warranty is that **WOODMAXX™** will, at its option, provide replacement parts for this product. This is a parts warranty and specifically excludes labor. **WOODMAXX™** reserves the right to discontinue or change materials, parts, models or products, or to make substitutions. **WOODMAXX™** will ship all replacement parts USPS mail or UPS ground, express shipping options are available only at an extra cost to the customer. Photos of the damaged parts may be required for replacement. By purchasing a **WOODMAXX™** you agree to the terms of service as described in this warranty.

WARRANTY LIMITATIONS

This warranty does not apply to normal wear and tear, commercial or rental use, after-market modification, or damages which arise from negligence, misuse, use not in accordance with the product instructions and if in the event there is a dispute, **WOODMAXX™** in its sole discretion will make the final decision with regard to whether or not the product is covered by the **WOODMAXX™** warranty. Repairs made under this warranty will not extend the warranty period. If you are unwilling or unable to perform the labor required on your **WOODMAXX™** product, **WOODMAXX™** will return the machine to the **WOODMAXX™** facilities. We will refund your purchase amount prorated according to the amount of use on the machine. All items must be returned with the machine, any missing parts will be deducted from the refund. The cost of shipping will be either the customer's responsibility or **WOODMAXX™**'s, which will be determined on a case by case basis.

LIMITATION OF DAMAGES

The warranty and remedies as set forth above are exclusive and in lieu of all others, oral or written, express or implied. In no event will **WOODMAXX™** be liable for any damages, including incidental or consequential damages, arising out of the use or inability to use this product.

LIMITATIONS OF WARRANTIES

Any express or implied warranties, including warranties of merchantability and fitness for a particular purpose, shall be limited to the duration and terms of the express written warranty.

WARRANTY PARTS POLICY

If covered replacement parts are not in stock, they will be ordered by **WOODMAXX™** and the customer will be notified when replacements parts are available. **WOODMAXX™** will not be liable for any damages associated with the unavailability of parts, including consequential damages or delay damages. **WOODMAXX™** may require a deposit for parts sent out if the part **WOODMAXX™** requires the defective part returned. **WOODMAXX™** reserves the right to refuse shipment of repair parts if the customer refuses to commit to a deposit. **WOODMAXX™** also may require pictures or videos of the issue in question before sending out parts. Any issues will be attempted to be resolved with providing of parts before returning the machine; any returns will be accepted at the sole discretion of **WOODMAXX™**.

WARRANTY EXCLUSIONS

Belts, knives, engines, hydraulic hoses, and finish are specifically excluded from this warranty. **WOODMAXX™** is not liable for any incidental damage caused by its products, including but not limited to, any damage to tractors or other machinery used in connection with its products. **WOODMAXX™** is not liable for damage incurred during shipping; any damage incurred in shipping must be noted on the bill of lading at the time the machine is accepted. A shipping damage claim will be made on your behalf. You also have the right to refuse the machine if it is severely damaged. **WOODMAXX™** does not offer or guarantee color matching with any particular tractor color. **WOODMAXX™** will not accept returns due to dissatisfaction with the color. If the customer is concerned about the color of the implement, the customer must request a paint sample before ordering.



WoodMaxx Power Equipment, Ltd.

42 Jackson Street • Akron, NY 14001

1.855.966.3629

www.WOODMAXX.com