

EP Decking – Wood Plastic Composite (WPC) Surface Mount Fencing Guide



EP Fence are made from Wood Plastic Composite materials that are durable and reliable, designed to withstand all weather conditions. The fences are mold, mildew and rot resistant. It is not only provide privacy, it also make outdoor space look elegant. No painting or staining are needed. Easy installation on any surfaces with the correct base holder. 2 different patterns in same fence board. TWO WPCFB & ONE WPCF-A01 made a 6' x 6' fence panel.

- ✓ Wood Plastic Composite (WPC)
- ✓ Resistant to Mold, Mildew, Rotting, & Termites
- ✓ 100% Waterproof, Non-Toxic, Anti-Slip, Anti-Scratch, Anti-Stain, & Fire Resistant!
- ✓ Easy to Install!
- ✓ Enhances your outdoor space
- ✓ No painting or staining is required

WPCF1001- (P1B/P4/C03/C04)BSR2 Fence Parts			
Item	Descriptions	Quantity	
WPCFB	6 pieces WPCF Fence Boards. Board Size: 3/4" x 6" x 70 1/2"	4	
WPCFA01	Aluminum Alloy Gray End/Line/Corner Post Kit	3	
Each Aluminum Alloy Gray Post Kit Includes:			
Model #	LHMZL005A	Quad Directional 74" Post (G)	1
	LHMZL014	Top Board Cover (K)	1
	LHMZL031	Bottom Board Rail (J)	1
	LHMZL007	Post Cap (I)	1
	LHMZL006	Post Side Cover (A)	3
	LHMZL029	Corner Clip (E)	2
	SBPHT4x20	Screws	4
	BHNOF8x50	Bolts (C)	2
	NHM8	Nut (C)	2
	WSD8	Washer (C)	2
Post Holder	LHMZL003	Bottom Squared Post Holder For Surface Mount	3

*****Please read all instructions before installing your new fence.**

*****Above the Surface Installation**

1. **Squared Bottom Post** - Dig a hole where you would like to begin building your fence.

Then, fill in the hole with cement and let cure for **48 hours** or until completely dry. Start with step 2 if installing on existing cement.

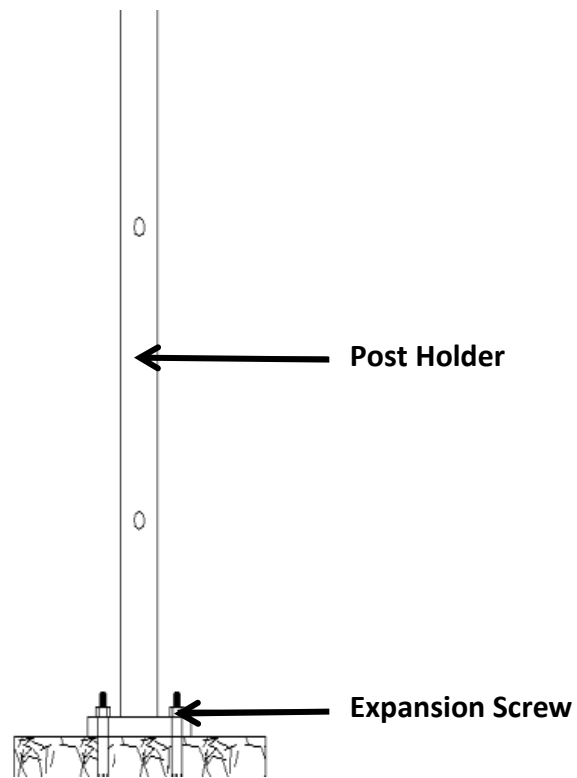

2. Drill the **Square Bottom Post** into the existing concrete with four expansion screws. The distance between centers of two posts is 72". Insert the post inside the post holder.

Made sure that it is completely vertical and straight.

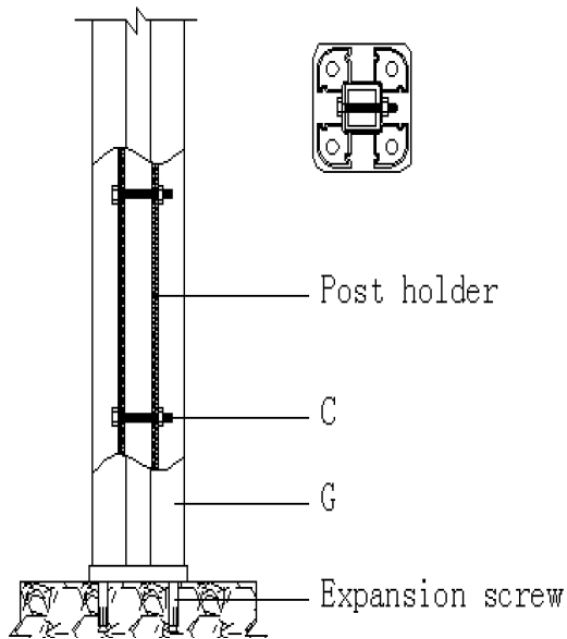

3. Once everything is lined up properly, fit the bottom cover to the post.

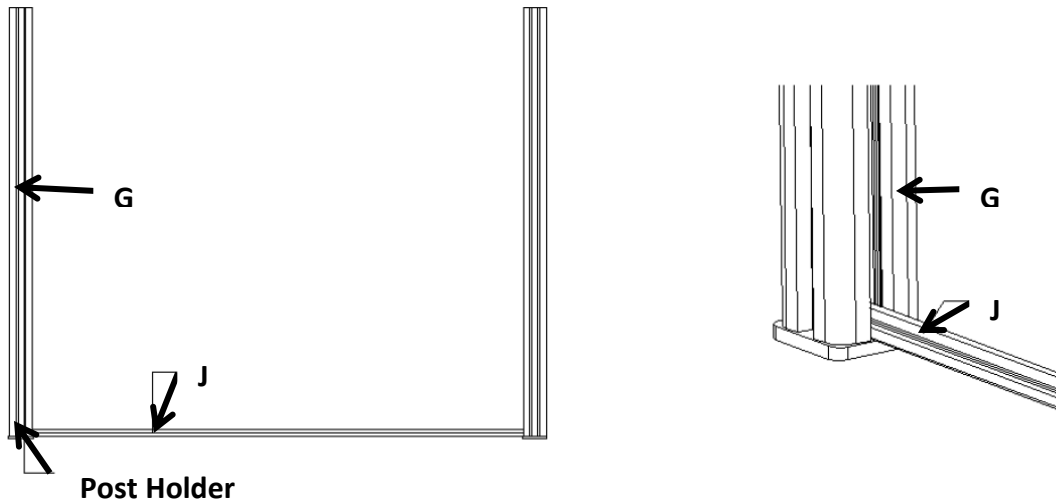

4. Insert your boards horizontally from the top to the bottom.

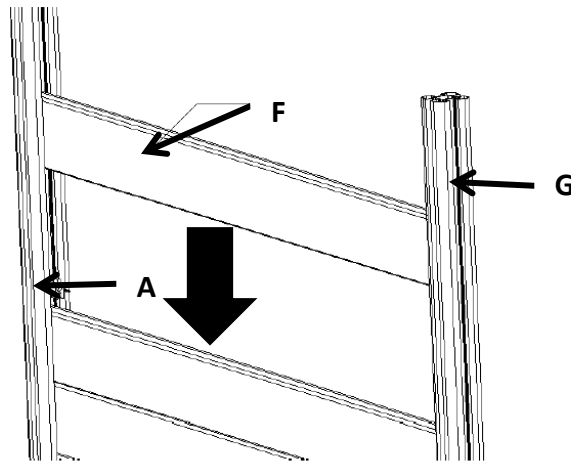
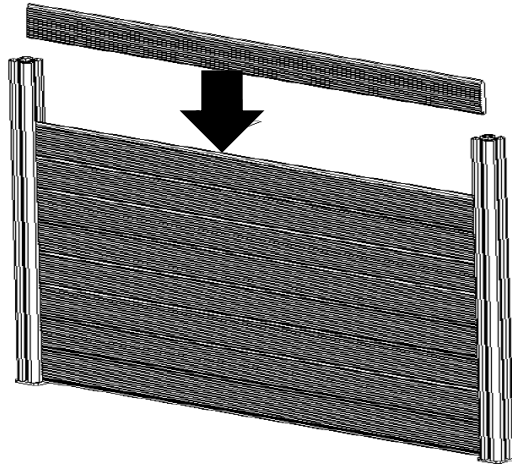

5. Insert the side bar, fitting the top cover to the post, and fasten with a corner clip.

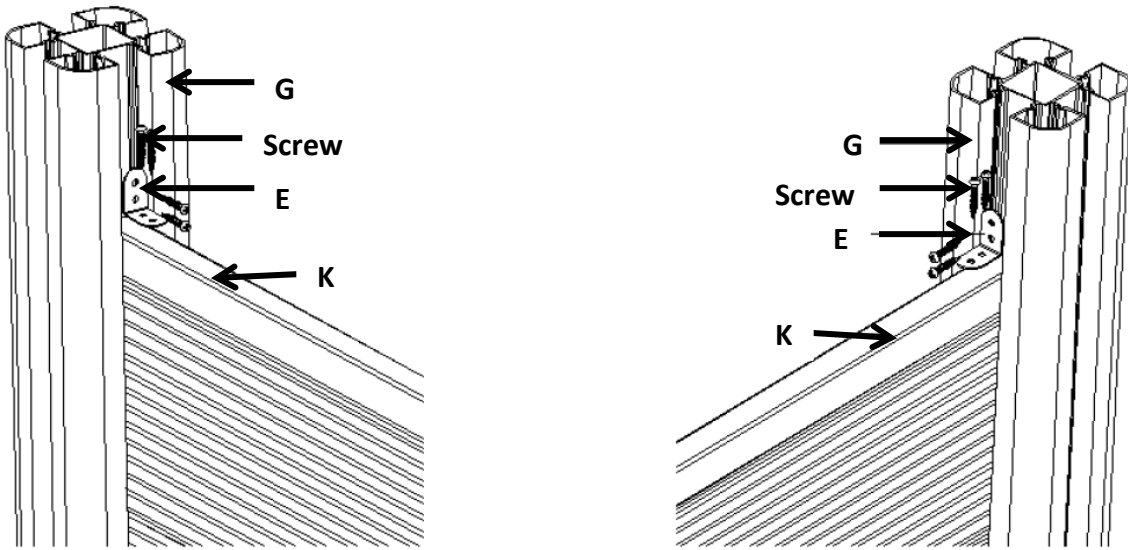

6. Finally, fasten the post cap on top.

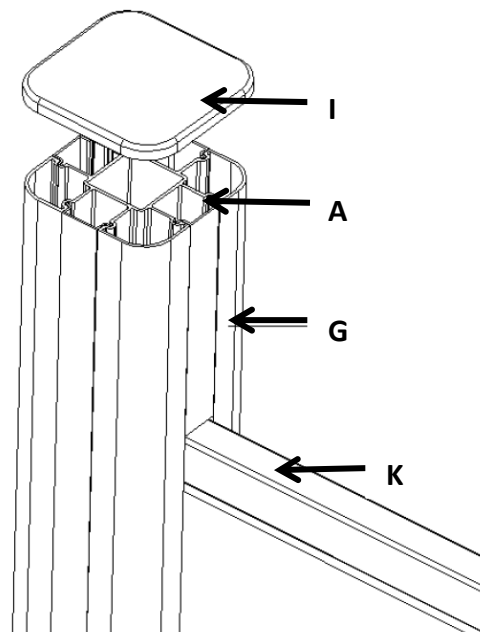



Do you have questions, comments, or concerns? E-mail us (info@epdecking.com) or call us at **(866) 344-2600 (Sales)**. Thank you and....

Enjoy Your New Fence!