

EP Decking – Wood Plastic Composite (WPC) Surface Mount Fencing Guide



EP Decking fences are made from durable and weather-resistant Wood Plastic Composite (WPC) materials. Designed for elegance and privacy, they resist mold, mildew, rot, and termites. No painting or staining is required, and the fences are easy to install on various surfaces using the proper base holder. Each fence panel consists of two WPCFB boards and one WPCF-A01 board, forming a 6' x 6' panel.

- ✓ Wood Plastic Composite (WPC)
- ✓ Resistant to Mold, Mildew, Rotting, & Termites
- ✓ 100% Waterproof, Non-Toxic, Anti-Slip, Anti-Scratch, Anti-Stain, & Fire Resistant!
- ✓ Easy to Install!
- ✓ Enhances your outdoor space
- ✓ No painting or staining is required

WPCF1001- (P1B/P4/C03/C04)BSR5 Fence Parts			
Item	Descriptions	Quantity	
WPCFB	6 pieces WPCF Fence Boards. Board Size: 3/4" x 6" x 70 1/2"	10	
WPCFA01	Aluminum Alloy Gray End/Line/Corner Post Kit	6	
Each Aluminum Alloy Gray Post Kit Includes:			
Model #	LHMZL005A	Quad Directional 74" Post (G)	1
	LHMZL014	Top Board Cover (K)	1
	LHMZL031	Bottom Board Rail (J)	1
	LHMZL007	Post Cap (I)	1
	LHMZL006	Post Side Cover (A)	3
	LHMZL029	Corner Clip (E)	2
	SBPHT4x20	Screws	4
	BHNOF8x50	Bolts (C)	2
	NHM8	Nut (C)	2
	WSD8	Washer (C)	2
Post Holder	LHMZL003	Bottom Squared Post Holder For Surface Mount	6

*****Please read all instructions before installing your new fence.**

*****Above the Surface Installation**

1. Installing the Squared Bottom Post:

Dig a hole at the starting point of your fence.

Fill the hole with cement and let it cure for **48 hours** or until completely dry.

Installation on cold weather may need extra time. Final concrete must have a minimum density of 150 lbs/cu ft.

If installing on existing cement, skip to Step 2.

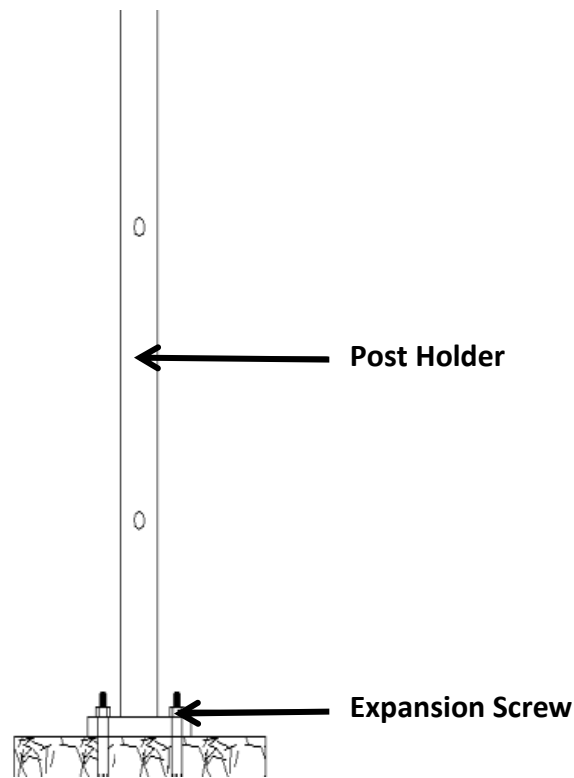

2. Drill and Mount Posts:

For existing concrete, the existing concrete floor must have minimum thickness of 6" with minimum of 150 lbs/cu ft.

Drill holes 9/16" in diameter and 2 1/8" deep.

Insert the expansion anchors without nuts into the holes, line up with the holes and affix the post holder securely with nuts.

Ensure the side with holes does not face the direction where the fence boards will be installed.

Confirm the post is perfectly vertical (90° to the ground).

For sections of 6", maintain a distance of 72 inches between the centers of two post holders. Please adjust accordingly for distance less than 72 inches.

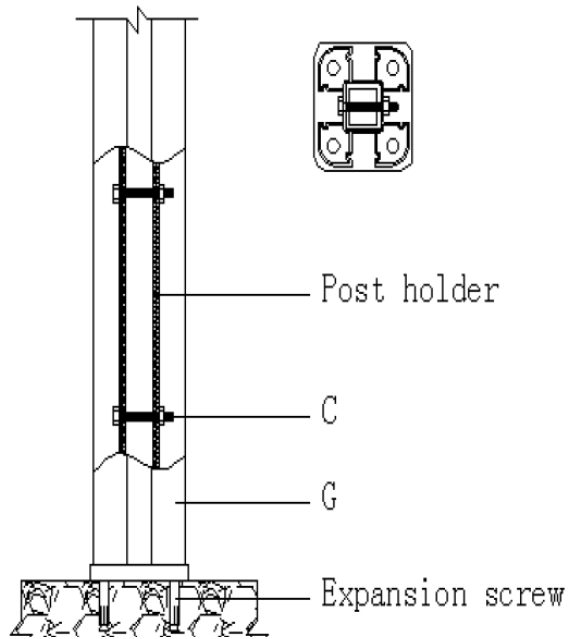

3. Fit the Bottom Cover:

Slide the bottom board rail onto the post, ensuring it fits snugly for a finished look.

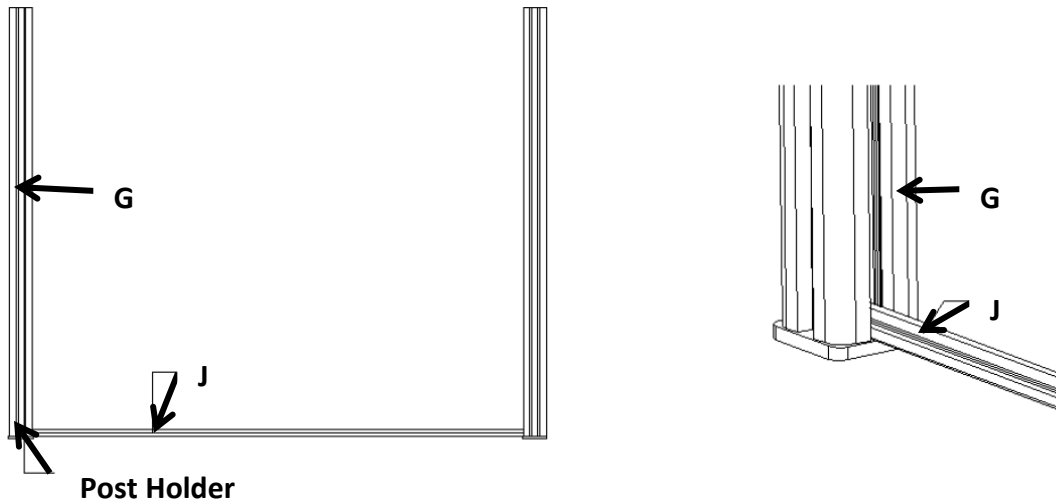

4. Insert Fence Boards:

Starting from the bottom, insert the boards horizontally. Ensure they align evenly.

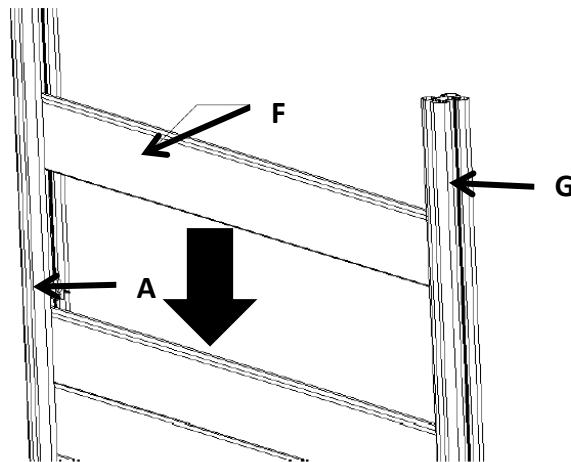
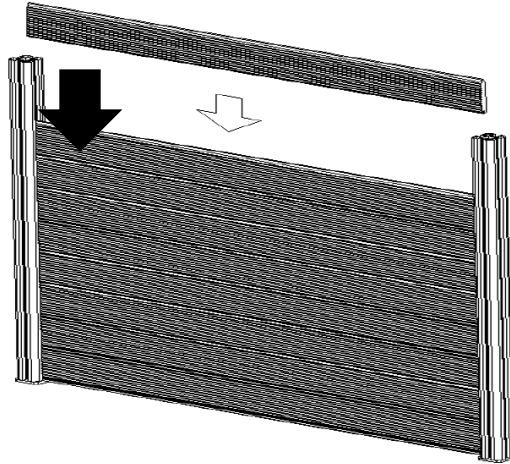

5. Install Side Bar and Top Cover:

Attach the side bar to the post. Fit the top board cover and secure with corner clips.

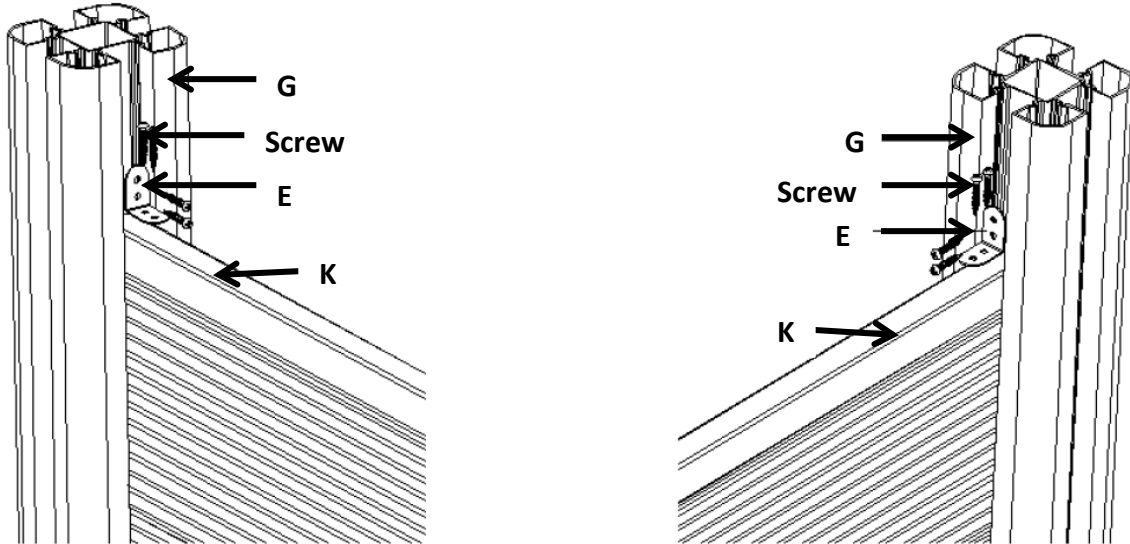

6. Attach the Post Cap:

Secure the post cap to the top of the post using screws.

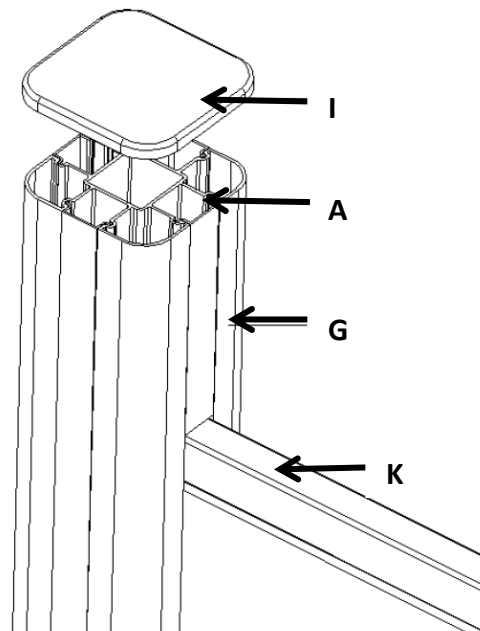

Support

For questions or concerns, contact us:

Email: info@epdecking.com

Phone: (866) 344-2600 (Sales)

Enjoy Your New Fence!