

# SALAV

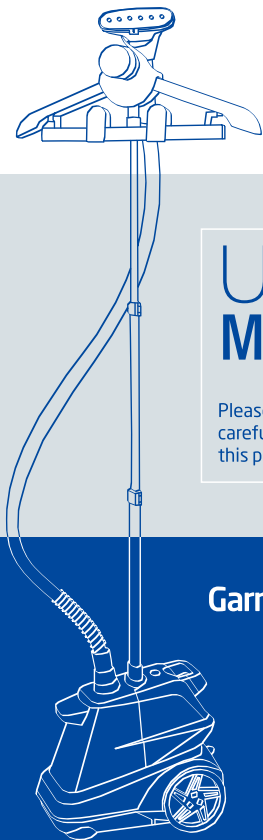

## USER MANUAL

Please read all instructions  
carefully before using  
this product.

### Garment Steamer

Model: X3



[www.salavusa.com](http://www.salavusa.com)

## Dear Valued Customer

Thank you for purchasing this SALAV product. Please read this manual prior to using your SALAV appliance. For more product information, FAQ and customer support please visit our website at [www.salavusa.com](http://www.salavusa.com).

### Important Safety Instructions:

1. Prior to first use, inspect all parts of the steamer to make sure all parts are intact. The steamer must not be used if it has been dropped, if there are visible signs of damage to the body or cord or if it is leaking.
2. DANGER - any appliance is electrically live even when the switch is off.
3. To reduce the risk of death by electric shock always unplug this steam mop from the electrical outlet immediately after using and before cleaning.
4. Do not reach for an appliance that has fallen in to water. Unplug it immediately.
5. Do not immerse or let appliance to be soaked in water. Do not use while bathing or in the shower.
6. This appliance is not a toy and should not be used by children. Close supervision is necessary when this appliance is used near children, or individuals with certain disabilities. Unsupervised use could result in fire or personal injury.
7. Never pull on the cord to disconnect from the electrical outlet; grasp plug and pull to disconnect.
8. To reduce the risk of electric shock, do not disassemble or attempt to repair the appliance; take it to a qualified service person for examination and repair, or call the appropriate toll free number in this manual. Incorrect reassembly or repair could cause a risk of fire, electric shock, or injury while steaming.
9. To reduce the likelihood of circuit overload, do not operate another high wattage appliance on the same circuit.
10. Use this appliance only for its intended use. Do not use attachments not specified in this manual.
11. If an extension cord is absolutely necessary, a cord with a 15 ampere rating should be used. A cord rated for less amperage can result in a risk of fire or electric shock due to overheating. Care should be taken to arrange the cord so that the cord cannot be pulled or tripped over.
12. Burns can occur from touching steam output vents, hot water, or steam. Do not hold your hand in front of steam.
13. Do not direct steam at people, animals, plants or clothes while they are being worn.
14. While steam is being emitted, this appliance may cause burns if it is used too close to the skin, scalp or eyes, or if it is used incorrectly. To reduce the risk of contact with hot water emitting from steam vents, test appliance before each use by holding it away from body.
15. Ensure the steam mop is properly assembled before use.
16. Do not place the appliance in the same spot for more than 10 seconds to avoid damage from heavy heating.
17. Do not touch the bottom of the appliance during operation.
18. Do not tilt or turn the appliance over when in use. Only use on flat, horizontal surfaces.
19. Do not fill the water tank with hot water or corrosive cleaning agents. Distilled water is strongly recommended.
20. Do not use on any unsealed hard floor surfaces. Additionally, on surfaces that have been treated with wax or some no-wax floors, the sheen may be removed by the heat and steam action. It is always recommended to test an isolated area of the surface to be cleaned before proceeding. We also recommend that you check the use and care instructions from the floor manufacturer.

# COMPONENTS

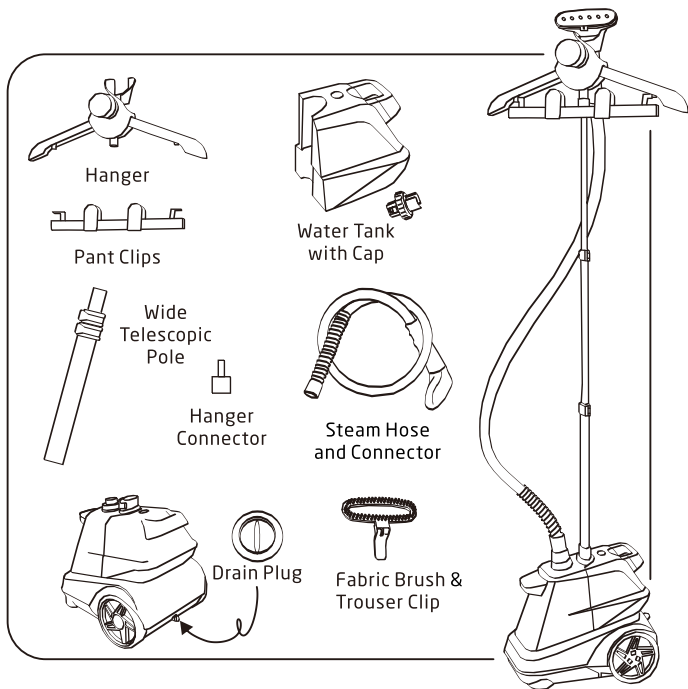

## PRODUCTSPECIFICATION

Model	X3
WaterTankCapacity	3.0L
SteamReadyTime	50seconds
InputVoltage	125V~ 60Hz
OutputPower	1800W

# SETTING UP YOUR GARMENT STEAMER

## STEP 1

Insert the Telescopic Pole and securely fasten the latch.

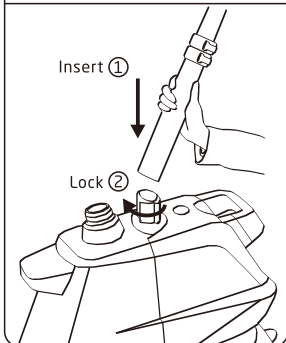

## STEP 2

Attach the Folding Hanger to the top of the Telescopic Pole. Extend the Telescopic Pole to desired height and lock in place.

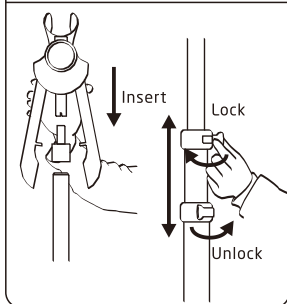

## STEP 3

Install the Steam Hose and tighten the Hose Connector.

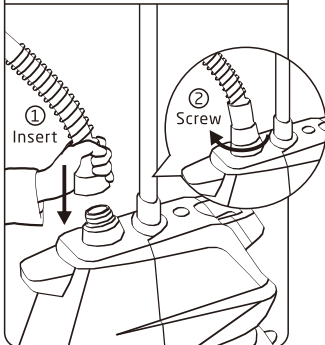

## STEP 4

Fully extend Hanger Arms and hang the Steam Nozzle.

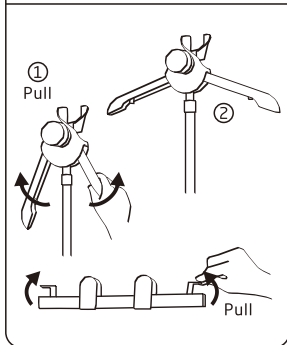

## SETTING UP YOUR GARMENT STEAMER

### STEP 5

Insert 1 side of the pants clip first then the opposite side.

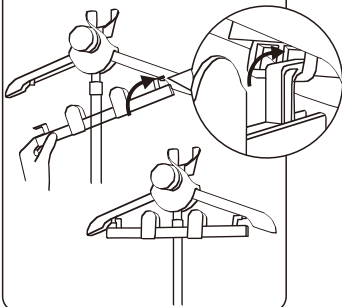

### STEP 6

Fully extend Hanger Arms and hang the Steam Nozzle.

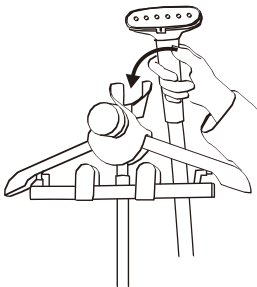

## INSTRUCTIONS FOR USE

### STEP 1

Remove the Cap. Fill the Water Tank. Replace & tighten the Cap.

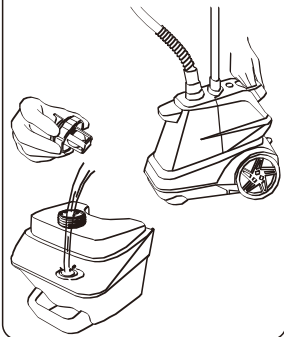

### STEP 2

Plug in & Turn on.

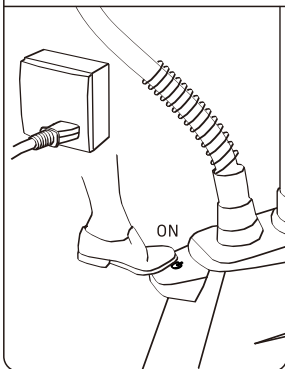

## INSTRUCTIONS FOR USE

### STEP 3

Allow 50 seconds for the device to completely warm up.

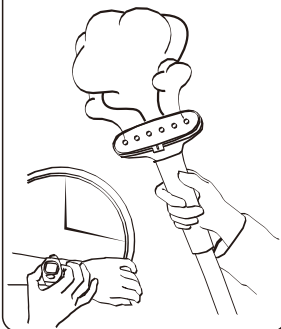

### STEP 4

Ready for steaming.

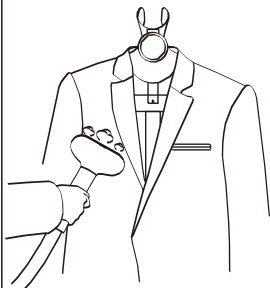

## MAINTENANCE AND CLEANING

### STEP 1

Turn off the unit and unplug it. Wait at least 30mins until the unit cools down completely.

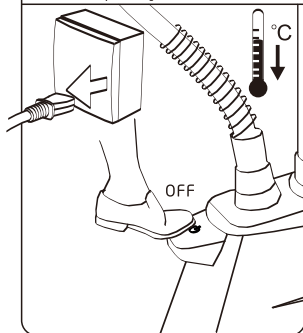

### STEP 2

Unscrew the Drain Plug and empty the water reservoir. Collapse and remove the Telescopic Pole & Steam Nozzle.

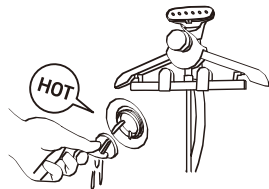

Attention: Tighten the Drain Plug back into place after water reservoir is emptied. Make sure Drain Plug is tightly secured each time before use.

## REMOVING MINERAL BUILD-UP

### STEP 1

Turn off and unplug the unit and cool for at least 30mins. Remove water tank. Mix water & vinegar solution and pour into water reservoir.

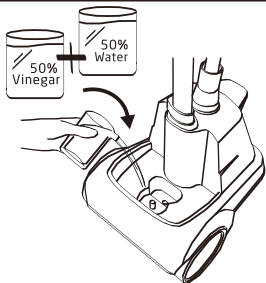

### STEP 2

Wait for 40mins, unscrew the Drain Plug and drain the water reservoir. Pour clean water into reservoir and let it drain. After the reservoir is empty, replace and tighten the Drain Plug.

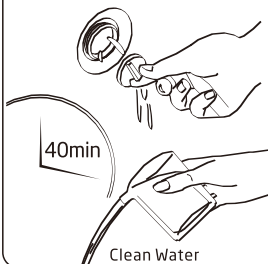

## ACCESSORIES ASSEMBLY AND USE

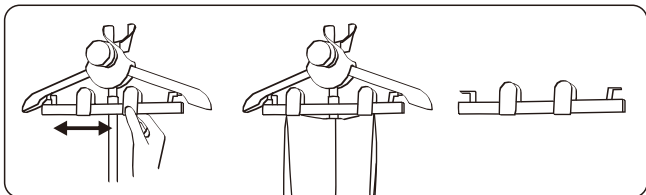
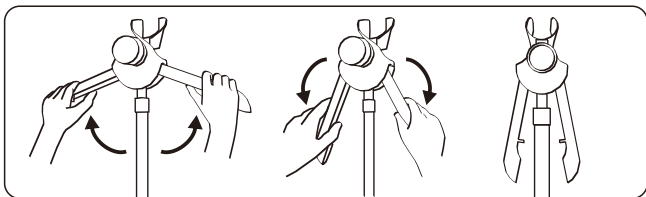

## ACCESSORIES ASSEMBLY AND USE

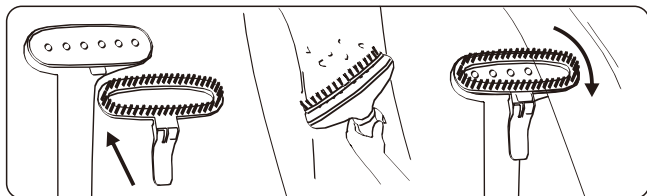



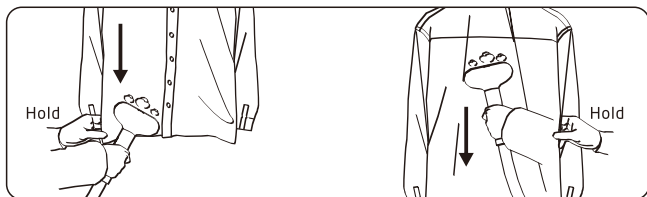
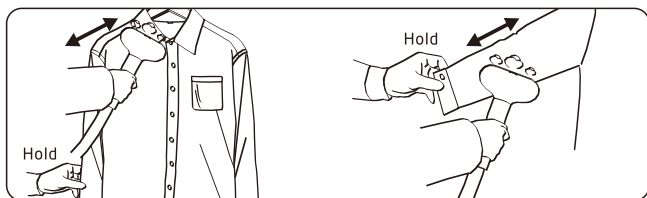
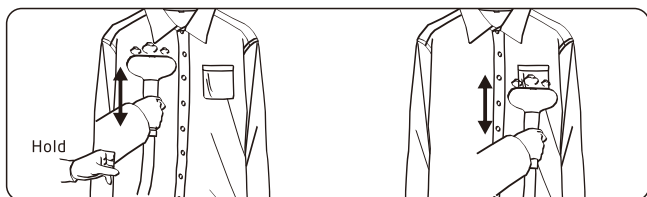



## HOW TO STEAM

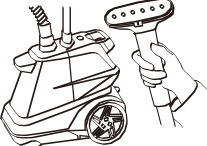
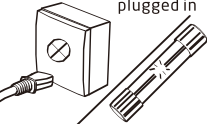
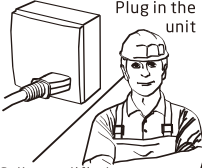

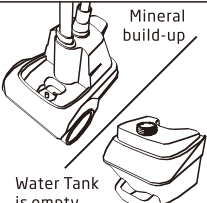
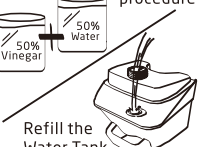
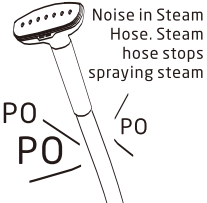
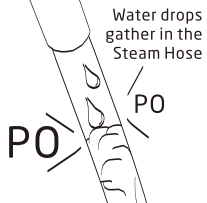
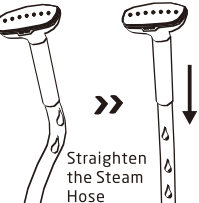

# TROUBLE SHOOTING

PROBLEMS	REASON	SOLUTION
<p>Unit fails to steam Indicating lamp does not illuminate</p> 	<p>The unit is not plugged in</p>  <p>Household power system problem /fuse is blown.</p>	<p>Plug in the unit</p>  <p>Call a qualified electrician for help.</p>
<p>Unit fails to steam Indicating lamp illuminates</p> 	<p>Mineral build-up</p>  <p>Water Tank is empty</p>	<p>Follow the removal mineral build-up procedure</p>  <p>Refill the Water Tank</p>
<p>Noise in Steam Hose. Steam hose stops spraying steam</p> 	<p>Water drops gather in the Steam Hose</p> 	 <p>Straighten the Steam Hose</p>
<p>Steam is intermittent</p> 	<p>Mineral build-up in Water Tank</p> 	<p>Follow the removal mineral build-up procedure</p> 

## Warranty exclusions and limitations

This Limited Product Warranty applies only to the original purchaser of the SALAV branded product that was purchased from SALAV directly or SALAV's authorized reseller. Without limiting the foregoing, the Limited Product Warranty does not apply to any (a) SALAV products and services other than the Brand New SALAV branded products which are purchased directly from SALAV or from SALAV's authorized reseller, (b) non-SALAV products, even if included or sold with a Product, including, without limitation, any counterfeit products, (c) products that are, or SALAV reasonably believes to be, stolen, (d) consumables (such as cleaning pads). This Limited Product Warranty does not apply to third party products or accessories, including but not limited to products with the "Made for SALAV" or "Works with SALAV" logos or advertising.

This Limited Product Warranty does not apply to a product or part of a product that has been replaced, repaired, serviced, altered, refurbished or modified by anyone who is not authorized by SALAV, nor does it apply to any cosmetic damage such as scratches and dents. In addition, this Limited Product Warranty does not apply to damage or defects caused by (a) use with non-SALAV products such as non-SALAV steamer liquid; (b) accident, abuse, misuse, mishandling, flood, fire, earthquake or other external causes; (c) normal wear and tear or aging of the product such as discoloration of product; or (d) operating the product (i) outside the permitted or intended uses described by SALAV under SALAV's Product User Manual , (ii) not in accordance with instructions provided by SALAV, or (iii) with improper voltage or power supply, water or other add-on products.

No SALAV, authorized reseller, distributor, agent, reseller, or employee is authorized to make any modification, extension or addition to this Limited Product Warranty. If any term contained herein is held to be illegal, void or unenforceable, the legality or enforceability of the remaining terms shall not be affected or impaired.

If you have any questions regarding this warranty, you may contact us through our website: [www.salavusa.com](http://www.salavusa.com)

## Limitation of Damages

Except to the extent prohibited by applicable law, SALAV shall not be liable for any incidental, indirect, special or consequential damages, including, without limitation, loss of profits, revenue, resulting from any breach of express or implied warranty or condition or under any other legal theory, even if SALAV has been advised of the possibility of such damages. SALAV warranty and liability is only limited to replacement of the defective item.

Visit our website to find product tips, customer support and learn about  
SALAV patented steam technology.  
[www.salavusa.com](http://www.salavusa.com)

