



# Birdfy

## Birdfy Feeder Hummee User Manual

EN

FR

ES

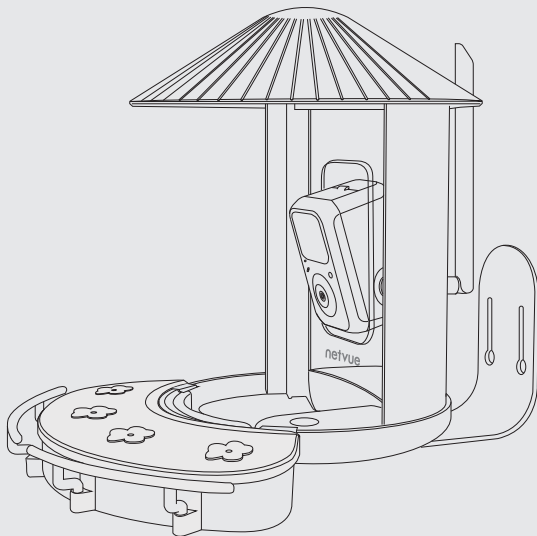



# Warning

Note: This equipment has been tested and found to comply with the limits for a Class B digital device, pursuant to part 15 of the FCC Rules. These limits are designed to provide reasonable protection against harmful interference in a residential installation. This equipment generates, uses and can radiate radio frequency energy and, if not installed and used in accordance with the instructions, may cause harmful interference to radio communications. However, there is no guarantee that interference will not occur in a particular installation. If this equipment does cause harmful interference to radio or television reception, which can be determined by turning the equipment off and on, the user is encouraged to try to correct the interference by one or more of the following measures:

- Reorient or relocate the receiving antenna.
- Increase the separation between the equipment and receiver.
- Connect the equipment into an outlet on a circuit different from that to which the receiver is connected.
- Consult the dealer or an experienced radio/TV technician for help.

This device complies with part 15 of the FCC Rules. Operation is subject to the following two conditions: (1) This device may not cause harmful interference, and (2) this device must accept any interference received, including interference that may cause undesired operation.

Any changes or modifications made without explicit approval from the responsible party in compliance may result in the user being unauthorized to operate the device.

This device meets the FCC radiation exposure limits for uncontrolled environments. To ensure safe installation and operation, maintain a minimum distance of 20cm between the radiator and your body.

**FCC ID: 2A08RNI-8111**

**CE Statement**

The information provided on the packaging is allowed to identify geographical areas within the member states where restrictions on use or requirements for authorized use exist, if applicable.

The structure of the product allows it to be used in at least one member state without violating applicable requirements for the use of radio spectrum.

**Manufacturer information:**

NETVUE INC.

1055 East Colorado Boulevard 5th Floor  
Pasadena, CA, 91106

# Catalog

What's in the Box	1-4
Inserting MicroSD Card	5-6
Camera Charging	7-8
Turning the Camera On & Off	9
Pre-Installation Notes	10
AI Bird Identification	13

# Catalogue

Contenu de la boîte	1-4
Insertion de la carte MicroSD	5-6
Chargement de la caméra	7-8
Allumer et éteindre la caméra	9
Notes préalables à l'installation	11
Identification des oiseaux par IA	13

# Catálogo

Qué hay en la caja	1-4
Cómo insertar una tarjeta MicroSD	5-6
Carga de la cámara	7-8
Encendido y apagado de la cámara	9
Notas previas a la instalación	12
Identificación de aves mediante IA	13

# What's in the Box



Roof  
Toit  
Techo



Screws for mounting on wood  
Vis pour montage sur bois  
Tornillos para montaje en madera



Anchors  
Ancres  
Anclajes



Perch screw  
Vis de la perche  
Tornillo de la percha

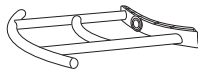

Perch  
Perche  
Percha

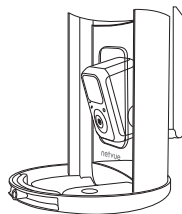

Feeder & camera  
Distributeur & caméra  
Feeder y cámara

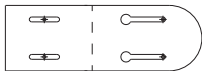

Drilling template  
Gabarit de perçage  
Plantilla de perforación

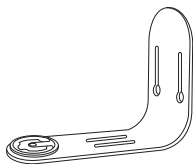

Mounting bracket  
Support de montage  
Soporte de montaje



Ejector pin  
Broche d'éjecteur  
Perno expulsor

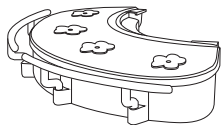

Hummee extension  
Extensióne Hummee  
Extensión Hummee

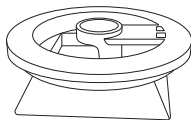

Tripod adapter  
Adaptateur de trépied  
Adaptador de trípode

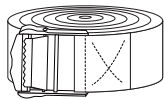

Black strap  
Sangle noire  
Correa negra



User Manual  
Manuel d'utilisateur  
Manual del usuario

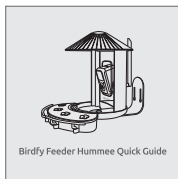

Quick Guide  
Guide rapide  
Guía rápida

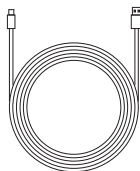

Type-C charging cable  
Câble de chargement Type-C  
Cable de carga Tipo-C

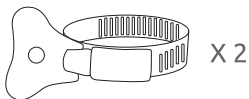

Hose clips (small)  
Pincas de tuyau (petites)  
Abrazaderas de manguera (pequeñas)

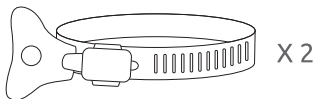

Hose clips (large)  
Pincas de tuyau (grandes)  
Abrazaderas de manguera (grandes)



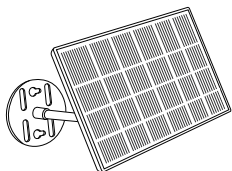

Solar panel + installation package  
Panneau solaire + kit d'installation  
Panel solar + paquete de instalación



X 3

Screws for mounting on concrete  
Vis pour montage sur béton  
Tornillos para montaje en concreto

\*Please note that if you have purchased the no-solar bundle, the package will not include a solar panel.

\*Veuillez noter que si vous avez acheté le bundle sans panneau solaire, le package ne comprendra pas de panneau solaire.

\*Por favor, ten en cuenta que si has comprado el paquete sin panel solar, este no incluirá un panel solar.

# Inserting MicroSD Card

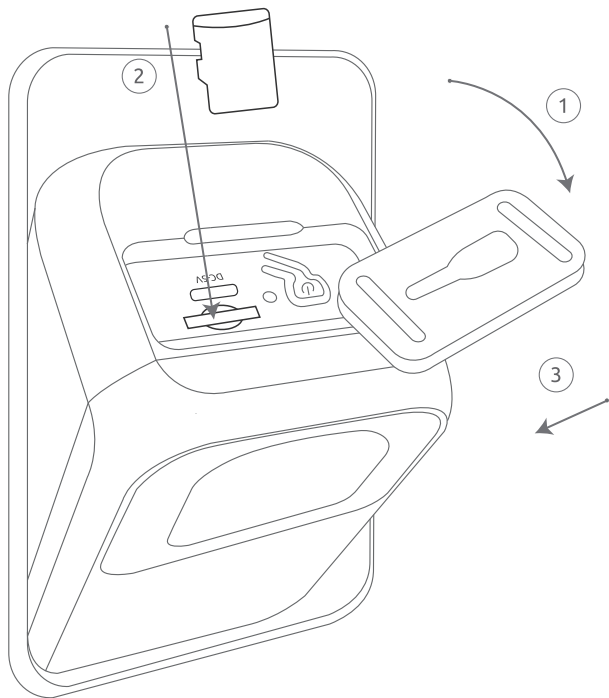

Birdfy Feeder comes with a built-in card slot which supports Class 10 microSD cards with capacities of up to 128GB.

**Step 1:** Rotate the camera downwards.

**Step 2:** Open the silicone cover and insert the microSD card. Make sure it is properly positioned with the label facing upward.

**Step 3:** Put back the silicone cover.

Birdfy Feeder est équipé d'un emplacement pour carte intégré qui prend en charge les cartes microSD de classe 10 d'une capacité allant jusqu'à 128 Go.

**Étape 1 :** Faites pivoter la caméra vers le bas.

**Étape 2 :** Ouvrez le couvercle en silicone et insérez la carte microSD. Assurez-vous qu'elle est correctement positionnée avec l'étiquette vers le haut.

**Étape 3 :** Remplacez le couvercle en silicone.

Birdfy Feeder viene con una ranura para tarjeta integrada que admite tarjetas microSD de clase 10 con capacidades de hasta 128 GB.

**Paso 1:** Gire la cámara hacia abajo.

**Paso 2:** Abra la tapa de silicona e inserte la tarjeta microSD. Asegúrese de que esté correctamente posicionada con la etiqueta hacia arriba.

**Paso 3:** Vuelva a colocar la tapa de silicona.

# Camera Charging

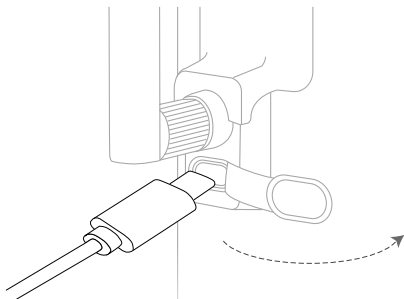

The camera does not come fully charged due to safety regulations. Before using it for the first time, please charge it for 14 hours with the charging cable inside the box (DC5V / 1A).

Status light is solid yellow: charging

Status light is solid green: fully charged

La caméra n'est pas entièrement chargée en raison des réglementations de sécurité.  
Avant de l'utiliser pour la première fois, veuillez la charger pendant 14 heures avec le câble de chargement dans la boîte (DC5V / 1A).  
La lumière d'état est jaune fixe : en charge  
La lumière d'état est verte fixe : complètement chargée

La cámara no viene completamente cargada debido a las regulaciones de seguridad.  
Antes de usarla por primera vez, cárguela durante 14 horas con el cable de carga dentro de la caja (DC5V / 1A).  
La luz de estado es amarilla sólida: cargando  
La luz de estado es verde sólida: completamente cargada

# Turning the Camera On & Off

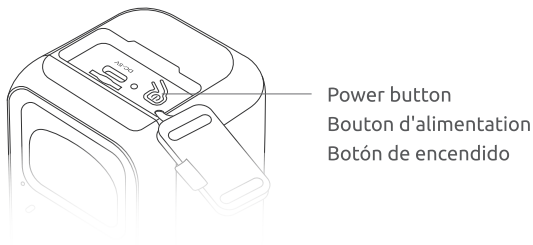

## **Powering on or off:**

Long press the power button at the top of the camera.

## **Mise en marche ou arrêt :**

Maintenez enfoncé le bouton d'alimentation situé en haut de la caméra.

## **Encendido o apagado:**

Mantén presionado el botón de encendido en la parte superior de la cámara.

# Pre-Installation Notes

1. Keep Birdfy Feeder and all accessories out of the reach of children and pets.
2. Make sure the camera is fully charged (DC5V / 1A).
3. Working temperature: -10°C to 50°C (14°F to 122°F)  
Working relative humidity: 0-95%
4. Please avoid exposing the camera lens to direct sunlight.
5. The camera has an IP65 waterproof rating, which allows it to function properly in rainy or snowy conditions. However, it should not be submerged in water.

**Note:**

1. Birdfy Feeder only works with 2.4GHz Wi-Fi.
2. Strong light may interfere with the device's ability to scan QR codes.
3. Avoid placing the device behind furniture or near a microwave oven. Please try to keep it in the range of your Wi-Fi signal.

# Notes préalables à l'installation

1. Gardez Birdfy Feeder et tous les accessoires hors de portée des enfants et des animaux domestiques.
2. Assurez-vous que la caméra est complètement chargée (DC5V / 1A).
3. Température de travail : -10°C à 50°C (14°F à 122°F)  
Humidité relative de travail : 0-95%
4. Évitez d'exposer l'objectif de la caméra à la lumière directe du soleil.
5. La caméra a une cote d'étanchéité IP65, ce qui lui permet de fonctionner correctement par temps de pluie ou de neige. Cependant, elle ne doit pas être immergée dans l'eau.

## **Noter :**

1. Birdfy Feeder ne fonctionne qu'avec le Wi-Fi 2.4 GHz.
2. Une forte lumière peut perturber la capacité de l'appareil à scanner les codes QR.
3. Évitez de placer l'appareil derrière des meubles ou à proximité d'un four à micro-ondes.  
Essayez de le garder dans la portée de votre signal Wi-Fi.



# Notas previas a la instalación

1. Mantenga Birdfy Feeder y todos los accesorios fuera del alcance de niños y mascotas.
2. Asegúrese de que la cámara esté completamente cargada (DC5V / 1A).
3. Temperatura de trabajo: -10°C a 50°C (14°F a 122°F)  
Humedad relativa de trabajo: 0-95%
4. Por favor, evite exponer la lente de la cámara a la luz solar directa.
5. La cámara tiene una clasificación de impermeabilidad IP65, lo que le permite funcionar adecuadamente en condiciones de lluvia o nieve. Sin embargo, no debe sumergirse en agua.

## **Nota:**

1. Birdfy Feeder solo funciona con Wi-Fi de 2.4 GHz.
2. La luz fuerte puede interferir con la capacidad del dispositivo para escanear códigos QR.
3. Evite colocar el dispositivo detrás de muebles o cerca de un horno de microondas.  
Por favor, trate de mantenerlo dentro del alcance de su señal Wi-Fi.

# AI Bird Identification

If you bought the Birdfy Feeder AI, this feature is included and activated automatically, without any additional cost.

If you have the Birdfy Feeder Lite, you need to subscribe to access this feature.

With AI Bird Identification, you can find out in real-time which bird species are visiting your feeder.

Si vous avez acheté le Birdfy Feeder AI, cette fonctionnalité est incluse et activée automatiquement, sans frais supplémentaires.

Si vous avez le Birdfy Feeder Lite, vous devez vous abonner pour accéder à cette fonctionnalité.

Avec l'identification des oiseaux basée sur l'IA, vous pouvez savoir en temps réel quelles espèces d'oiseaux visitent votre mangeoire.

Si ha comprado el Birdfy Feeder AI, esta función está incluida y se activa automáticamente, sin costo adicional.

Si tiene el Birdfy Feeder Lite, necesita suscribirse para acceder a esta función.

Con la identificación de aves basada en IA, puede descubrir en tiempo real qué especies de aves visitan su comedero.



Learn more on [www.birdfy.com](http://www.birdfy.com)



Contact us at:

---



[support@birdfy.com](mailto:support@birdfy.com)



In-App Chat



1(886)749-0567

Mon-Fri, 9am-5pm, PST



@birdfy by netvue

[www.birdfy.com](http://www.birdfy.com)  
© Netvue Inc.