



XP Mid-Frame Winches

Owner's Manual



SAVE THESE INSTRUCTIONS

Thank you very much for choosing an X-Power™ product!

For future reference, please complete the owner's record below:

Serial Number/Lot Date Code: _____

Purchase Date: _____

Save the receipt, warranty, and this manual. It is important that you read the entire manual to become familiar with this product before you begin using it.

This electric winch is designed for certain applications only. Forcome Co., Ltd. is not responsible for issues arising from modification or improper use of this product such as an application for which it was not designed. We strongly recommend that this product not be modified and/or used for any application other than that for which it was designed.

For technical questions, please contact our customer support.











Call: 888-380-7428

Email: parts@uriahproducts.com

Table of Contents

Symbols Index	3
Important Safety Information	4
Specific Operation Warnings	4
Intended Use	6
Technical Specifications	6
Assembly Instructions	7
Before Each Use	11
Operating Instructions	11
After Each Use	14
Maintenance	14
Troubleshooting	15
Replacement Parts	15
Parts Diagram	16
Parts List	16
Warranty Information	17

Symbols Index

	Read All Product Literature		Always use supplier Hook Strap
	Never Use Winch as a Hoist		Fairlead Pinch Point
	Do not use to transport people or animals.		Never hook back on Rope
	Wind Rope from Bottom of Drum		Never Apply Load to Hook Tip
	Finger Crushing Hazard		Avoid Pinch and Wear/Abrasion Points on Electrical Cable
	Properly Seat Load in Throat of Hook		Never Route electrical cable over sharp edges

Important Safety Information

WARNING

WORK AREA SAFETY

- Inspect the work area before each use. Keep work area clean, dry, free of clutter, and well-lit. Cluttered, wet, or dark work areas can result in injury. Using the electric winch in confined work areas may put you dangerously close to other cutting tools and rotating parts.
- Keep children and bystanders away from the work area while operating the tool. Do not allow children to handle the electric winch.
- Always make sure you have control of vehicle and area around it. Make sure no personal or property damage can occur if vehicle rolls back during winching operation.

WARNING

PERSONAL SAFETY

- Stay alert, watch what you are doing, and use common sense when operating the electric winch. Do not use the electric winch while you are tired or under the influence of drugs, alcohol, or medication. A moment of inattention while operating the tool may result in serious personal injury.
- Dress properly. Do not wear loose clothing, dangling objects, or jewelry. Keep your hair, clothing, and gloves away from moving parts. Loose clothes, jewelry, or long hair can be caught in moving parts. Air vents on the tool often cover moving parts and should be avoided.
- Wear the proper personal protective equipment when necessary. Use ANSI Z87.1 compliant safety goggles (not safety glasses) with side shields, or when needed, a face shield. Use a dust mask in dusty work conditions. Also, use non-skid safety shoes, hardhat, gloves, dust collection systems, and hearing protection when appropriate. This applies to all persons in the work area.
- Do not overreach. Always keep proper footing and balance.

CAUTION

WINCH USE AND CARE

- Inspect before every use. Do not use if parts are damaged, loose, or missing. Examine the winch for structural cracks, bends, damage, frayed or kinked rope, and any other conditions that may affect the safe operation of the winch. Do not use the winch even if minor damage appears. A kink permanently weakens the rope, even after it is straightened out; kinked rope can fail suddenly and must not be used.
- Do not force the winch. Products are safer and do a better job when used in the manner for which they are designed. Plan your work and use the correct product for the job.
- Store the winch when it is not in use. Store it in a dry, secure place out of the reach of children. Inspect the tool for good working condition prior to storage and before re-use.
- Use only accessories that are recommended by the manufacturer for use with your product. Accessories that may be suitable for one product may create a risk of injury when used with another tool. Never use an accessory that has a lower operating speed or operating pressure than the tool itself.
- Never use the winch to secure a load or as a tie-down. Leaving a load on the winch line for an extended period of time or during transportation can damage winch rope and gears.

Specific Operation Warnings

WARNING

GENERAL SAFETY

- To prevent injury or property damage, read and understand all instructions before operating winch.
- Wear ANSI Z87.1 compliant safety goggles and heavy-duty leather work gloves during operation.
- Do not exceed the rated load capacity. Be aware of dynamic loading! Sudden load movement may briefly create excess load causing product failure.

INSTALLATION SAFETY

- Choose a mounting location that can support the winch and rated load capacity.
- Do not weld mounting bolts

- Use supplied power cords and rope listed in manual only. Do not use thinner/longer cables or link multiple cables together.
- Keep hands clear of winch rope, hook loop, hook, and fairlead opening during installation, operation, and when spooling in or out.
- Wrap the rope under 500 lbs. of tension before use. Otherwise, the rope may bind during operation.
- Do not route electrical cables near sharp edges or parts that will move or become hot.
- Work in a well-ventilated area. Explosive hydrogen gas can accumulate and explode when ignited by a spark or open flame.
- Only connect to a clean, corrosion-free battery.
- Remove all jewelry and metallic objects before working near battery.

WINCHING SAFETY





- Inspect winch rope, hook, and slings before operating winch. Frayed, kinked, or damaged winch rope must be replaced immediately. Damaged components must be replaced before operation.
- Do not maintain power to the winch if the motor stalls. Verify the load is within the rated capacity for the rope layer. Make sure the battery is fully charged. Use double-line rigging whenever possible.
- Do not engage or disengage clutch while under load.
- Always ensure hook latch is closed and not supporting load.
- Never apply load to hook tip or latch. Apply load only to the center of hook.
- Never use a hook that has been bent, warped, or twisted.
- Keep clear of fairlead when operating. Do not try to guide rope.
- Do not place any fingers through the hook. Fingers may be caught and get pulled into the fairlead or drum. Use the included strap to hold the hook instead.
- Stay out of the direct line that the rope is pulling. If it slips or breaks, it will create a whiplash effect. Utilize a winch dampener to help absorb the force released if the rope breaks.
- Do not use for overhead hoisting. This winch is intended to be used for pulling only.
- Use a spotter to assist you with safe operation of the winch. Make sure the spotter is out of the way of the vehicle and the rope before activating the winch.
- Do not use the hand crank, if equipped, to assist the winch.
- Do not use vehicle to pull on the rope and "assist" the winch.
- Do not use to transport people or animals.
- Disconnect battery cables before working near the rope, drum, fairlead or load, to prevent accidental starting.
- Keep rope straight to avoid kinking the rope.
- Keep children and bystanders away while operating.
- Hook onto the object using a pulling point, tow strap, or chain. Do not wrap the rope around the object and hook onto the rope itself.
- Do not use a recovery strap while winching.
- Secure the load after moving. Do not lock the mechanism.
- Keep at least 5 full turns of rope on the drum.
- Keep clear of the rope, hook, and load while winching. Do not step over the rope or apply pressure to the rope under tension. The rope might break and cause personal injury.
- If the rope begins to get entangled, stop the winch immediately and release the rope using the switch.
- Only winch with the winching vehicle's transmission placed in neutral. Winching with a vehicle's transmission in gear or park may damage the transmission. A vehicle's transmission is not designed to handle this type of load.
- Do not operate the winch on extreme slopes. Do not exceed 45° from center line of vehicle for a roller fairlead. For a hawse fairlead, the angle should be as close to vehicle center line as possible.
- People with pacemakers should consult their physicians before use. Electromagnetic fields near heart pacemaker could cause pacemaker interference or failure.
- Remove all obstacles before operation.
- Always use supplied hook strap whenever spooling winch rope in or out, during installation, and during operation.
- Always take time to use appropriate rigging techniques for winch pull.

Intended Use

This electric winch is intended for vehicle recovery. It is intended only for consumer use and not intended for commercial use. Always operate this winch within the specified duty cycle with extreme caution. Read all Warnings and Cautions before operation of this winch and keep by standers away from winch and vehicles being used during winching activity.

Technical Specifications

Property	Specification	
Rated Single Line Pull	12,000lb (5443kg.)	10,000lb (4536kg.)
Application	Vehicle Recovery / For Trucks and SUVs	
Motor	12V DC 7.0 HP Series Wound	
Power In & Power Out	Yes	
Duty Cycle Rating	20% Maximum (See Instructions)	
Remote Control	Wired 12' (3.7m) / Wireless	
Gear Train	3-stage Planetary	
Gear Ratio	242:1	216:1
Free spool clutch	Locking Ring Gear	
Brake	Automatic Dual Disk	
Drum (Dia. XL)	2.75" x 8.8" (70mm x 223mm)	
Clevis Hook	3/8", Replaceable with Spring-Loaded Safety Latch	
Fairlead	Hawse / Roller (Optional LED Illuminated)	
Rope Size/Type	3/8" x 79' (10mm x 24m) Minimum Break Strength=14,400 lb. 7X19 Galvanized Steel Aircraft Wire Rope	0.35" x 82' (9mm x 25m) Minimum Break Strength=12,500 lb. 7X19 Galvanized Steel Aircraft Wire Rope
Battery	12V DC Minimum 650 CCA	
Battery Cables	3 AWG Minimum	
Mounting Bolt Pattern	10" x 4.5" (254mm x 114.3mm)	
Mounting Hardware	Winch: 2x M10 Security Screw + 2x M10 Hex Head (M10-1.50x30mm) Fairlead: 2x M12 Socket Head (M12-1.75x25mm)	
Overload Protection	Automatic Control Pack	
Sound Rating	85dB	
Overall Dimensions (LXDHX)	21.8" X 6.5" X 9.76" (554mm X164mm X247mm)	
Weight (WR/SR)	87.9 lb. (39.9kg) / 65.2 lb. (29.6 kg)	86.0 lb. (39.0kg) / 64.4 lb. (29.2kg)
IP Rating	IP68-Winch and Controls	

Layer	Rated Line pull		Rope Length/ Layer
	12000lb(5443kg)	10000lb(4536kg)	19' (5.9m)
	9685lb(4393kg)	8185lb(3713kg)	42' (12.8m)
	8119lb(3683kg)	6927lb(3137kg)	68' (20.7m)
	6989lb(3170kg)	6006lb(2724kg)	82' (25m)

First Layer of Rope Performance – 12,000 lb. winches				
	Line Pull lb.(kg)	Line Speed fpm(m/min)	Amp Draw (DC12V)	Max. Pull Length ft (m)
①	0(0)	27 (8.2)	59	82' (25.0m)
	3,000 (1,361)	10.6 (3.2)	146	20' (6.1)
	6,000 (2,722)	8.4 (2.6)	201	8' (2.4)
	9,000 (4,082)	6.9 (2.1)	260	3' (1.0)
	12,000 (5,443)	5.5 (1.7)	330	1' (0.3)
First Layer of Rope Performance – 10,000 lb. winches				
	Line Pull lb.(kg)	Line Speed fpm(m/min)	Amp Draw (DC12V)	Max. Pull Length ft (m)
①	0 (0)	29.8 (9.1)	57	82' (25.0m)
	2,000 (1,134)	12.7 (3.9)	132	21' (6.4)
	4,000 (2,268)	10.8 (3.3)	175	9' (2.7)
	6,000 (3,402)	9.2 (2.8)	211	4' (1.2)
	8,000 (3,629)	8.3 (2.5)	237	2' (0.6)
	10,000 (4,536)	7.0 (2.1)	292	1' (0.3)

Assembly Instructions

⚠ WARNING

Read the entire Important Safety Information section at the beginning of this manual including all text under subheadings before set up or use of this electric winch.

Mounting the Winch:

1. The mounting plate must be rated to at least the winch's capacity. It must be flat and strong enough to remain flat at maximum winch capacity. Winch must sit flat on winch mount with no gaps under drum supports. It must have the hole pattern shown below.

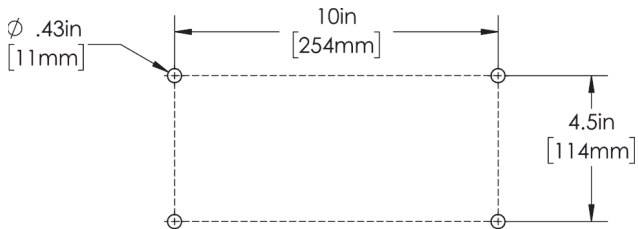

2. Align the winch perpendicular to centerline of the vehicle at the desired location and mark the locations of the winch base holes. Compare the dimensions of the marked holes.
3. Before drilling, verify that the installation surface has no hidden components or structural pieces that will be damaged.

NOTE: This winch can generate extreme forces. Select a location that can withstand the rated capacity without damage or weakening. Steel reinforcement plates may be required or a certified welder may need to weld on additional bracing depending on the mounting location.

4. Drill holes for the hardware at the marked locations.
5. Install the winch using hardware described under the specifications table. Torque mounting bolts to 30 ft.-lb. (41 Nm).

ITEM	DESCRIPTION	QTY.
1	Nut Square M10	4
2	Capscrew Hex M10X32mm	2
3	Capscrew M10x32 Security	2
4	Key Screw Security M10	1
5	Capscrew Sckt Hd M12 x 25mm	2
6	Nut Hex M12	2
7	Washer Flat M12	2
8	Washer Split M12	2
9	Washer Split M10	4
10	Capscrew Sckt Hd M10	2
11	Washer Flat M10	2

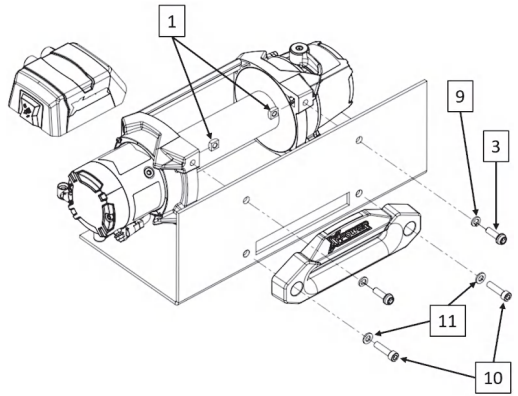
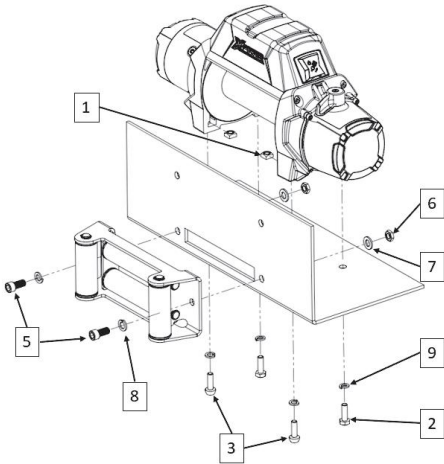
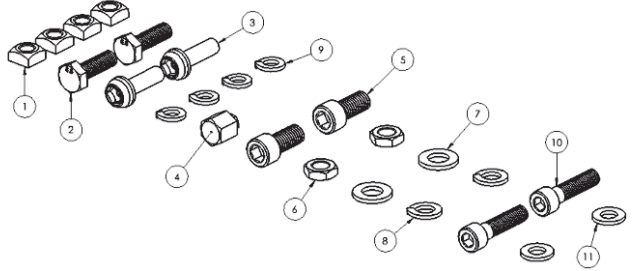

Wiring:

To prevent serious injury, from explosion, due to sparking at the battery connection, disconnect the Battery Cables before making other wiring connections.

To prevent serious injury from leaking battery acid, do not use a dirty, corroded, or leaking battery. Only use a 12V automotive (or equivalent) battery that is in good condition.

1. Plan a route for the wiring from the planned winch location to the battery. This route must be secured and out of the way of moving parts, road debris, or any location where parts may be damaged. For example, you may wish to route the wires under the vehicle, attaching it to the frame using suitable fasteners. Do not attach the wires to the exhaust system, drive shaft, emergency brake cable, fuel line, or any other components which may create damage to the wiring.
2. If you drill through the bumper or any part of the body to route the wires, be sure to

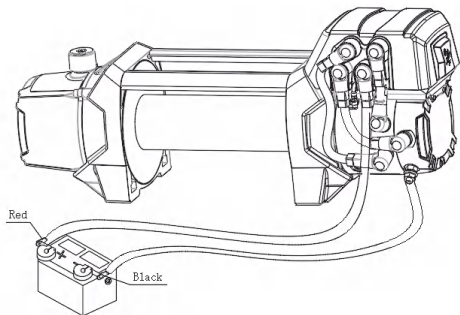

- install a rubber grommet in the hole to prevent fraying the wires.
3. Route the Cables from the winch to the battery, following the precautions discussed. See image below:
 4. Attach the red, black and yellow cables to their corresponding terminals on the winch.
NOTE: Be sure to connect the small Black wire from Control Pack to Black (-) terminal on motor same terminal as Negative (-) battery cable.
 5. Attach the red battery to the positive terminal on the battery.
 6. Attach the black battery cable directly to the negative terminal of the battery.
 7. Lift the socket cover exposing the electrical switch connector. Insert the pendant connector into the socket.
NOTE: The attachment of the Motor Cables determines the operation of the Remote button. After the unit is mounted and powered, check the direction of the Power In and Power Out on the Remote button. If you wish to change the direction on the Remote, disconnect the Battery Cables from the battery, switch the Motor Cable connections on the Motor Assembly, then reconnect the Battery Cables.
 8. Disconnect the pendant controller when not in use.

Preparing & Stretching Winch Rope:

WARNING:
<ul style="list-style-type: none"> • Always pre-stretch all new ropes before first use. Failing to pre-stretch rope will reduce maximum capacity of rope and may cause premature failure. • Always keep at least five (5) full wire rope wraps on the winch drum. Rope termination of anchor screw can fail with inadequate rope traction on drum. • Always keep at least eight (8) full synthetic rope wraps on the winch drum. Rope anchor screw can fail with inadequate rope traction on drum.

1. Position the vehicle on a flat surface approximately full rope length distance from anchor point such as large tree. **Always keep at least five (5) full rope wraps on winch drum.** The screw used to secure end of rope to drum may fail if there is not enough rope on drum.
2. Connect rope to anchor point with minimum number of wraps on drum.
3. Recoil the rope back into the winch under at least 1000lb (454kg) of tension. Apply light pressure to vehicle brake pedal as needed to produce load.
4. Stop approximately every minute to check rope is winding uniformly on the drum. Make sure vehicle is in park with parking brake applied before exiting vehicle. Do not check, touch or attempt to reposition rope with load on winch rope.

Remote Overview:

The Remote Control for your XP winch has many features. It can be operated as a corded remote by connecting it to the winch Control Pack. Connect cord to control pack by plugging into the remote socket on Control Pack and plug into back of Transmitter. It can also be operated as a wireless controller by turning the wireless control ON with the WIRELESS button of the face of transmitter.

The BLUE LED for the wireless control will be illuminated when the wireless is active. It will flash slowly when the transmitter battery is low. The light will remain on if the transmitter is taken out of range from the receiver (winch) but will not operate winch. Normal function will continue when transmitter is within range of winch.

This remote also has GREEN LEDs on either side of the wireless control front panel to indicate rope direction. The LED on the left will illuminate when the Power-In button is pressed. The LED on the right will illuminate when the Power-Out button is pressed.

Finally, this remote is also equipped with an LED Flashlight. Pressing the flashlight button will turn the light ON. It will turn OFF automatically after 5 minutes of inactivity. This remote can be charged with USB power cable so the flashlight can be used as needed.

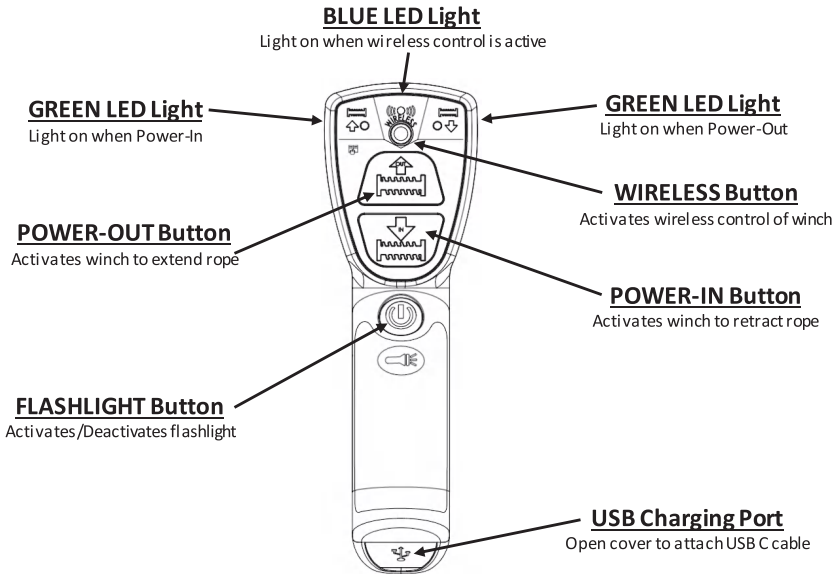

Function:

1. Connect Remote to Control Pack or activate the Wireless. Press and hold the WIRELESS button until the BLUE LED illuminates (approximately 3 seconds) to indicate wireless is active.
2. Press the "IN" button to Power-In winch rope. Press the "OUT" button to Power-Out winch rope.
3. Check Status lights on transmitter periodically while winching. The wireless control will turn off automatically after 10 minutes of inactivity. The BLUE LED for wireless will flash slowly when the transmitter battery is low.

NOTICE

To maximize the life of the remote, store the remote in the vehicle and keep it away from oil or water. Charge the remote at least once every six months to maximize the life of the battery.

METHOD FOR PAIRING WIRELESS REMOTE CONTROL TO WINCH:

1. Disconnect the 12v power supply to the winch.
2. Turn on the wireless mode for the remote control by holding the wireless button for 3 seconds, until the blue LED flashes, then release the wireless button.
3. Now press and hold both the IN and OUT buttons at the same time. All three LED lights will now flash at the same time.
4. At this time, restore the power connection to the winch.
5. Wait until the three LED lights on the remote control quit flashing and stay on, then release the IN and OUT buttons.
6. Once the blue LED stays on, the pairing is complete.
7. If pairing fails, disconnect the power to the winch, wait 15 minutes, and repeat the above operation.

Before Each Use

⚠ WARNING

- Inspect winch rope, hook, and slings before operating winch. Frayed, kinked, or damaged winch rope must be replaced immediately. Damaged components must be replaced before operation.
- Wrap the rope under 1000 lbs. of tension before use. Otherwise, the rope may bind during operation.
- Work in a well-ventilated area. Explosive hydrogen gas can accumulate and explode when ignited by a spark or open flame.
- Remove all jewelry and metallic objects before working near batteries.

Operating Instructions

⚠ WARNING

- Read the entire Important Safety Information section at the beginning of this manual, including all text under subheadings Before Setup or Use of This Electric Winch.
- The instructions that follow are basic guidelines only and cannot cover all situations encountered during use. The operator and assistants must carefully plan usage to prevent accidents.

1. Examine the rope. Do not use the winch if the rope is frayed, kinked, or damaged.
2. Fully charge the vehicle's battery.
3. Check the winch's electrical connections. All connections must be tight and clean.
4. Put the vehicle's transmission in Neutral.
5. If the vehicle connected to the winch must be stationary, engage the emergency brake and block the wheels using wheel chocks (sold separately).

WARNING: Never shift winch to free spool position with load on winch rope.

6. To pull out the rope, move the clutch control to the released position (shown below). Slide the loop of the hook strap over the hook, then pull on the **hook strap** to pull the winch rope from winch drum.
7. Hook onto the object using a pulling point, tow strap, tree strap, or chain.

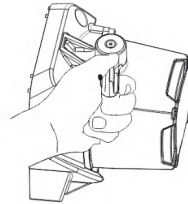

⚠ WARNING

Leave at least five full turns of rope on the drum.

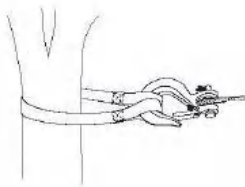

Do not wrap the rope around the object and hook onto the rope itself. This can damage the object being pulled, and kink or fray the rope.

8. Attachment point must be centered in loop of hook and the hook's safety clasp must be fully closed. (See image below.)

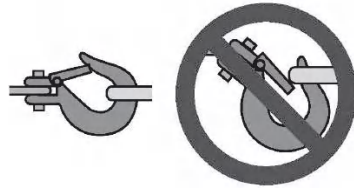

9. Do not use a recovery strap while winching. They are designed to stretch and can suddenly whip back towards the operator during operation.

10. Place a heavy rag or carpet (sold separately) over the rope span, 6 feet from the hook to help absorb the force released if the rope breaks.

11. Re-engage the clutch by moving the clutch handle to the engaged position (see image below).

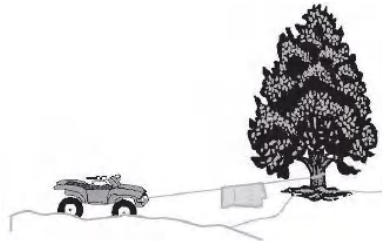
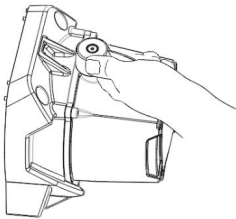

⚠ WARNING

Do not allow anyone to stand near the rope or in line with the rope behind the winch while it is under power. If the rope should slip or break, it can suddenly whip back towards the winch, causing a hazard for anyone in the area. Stand far to the side while winching.

12. Attach the pendant controller to the socket on the control pack assembly (see image to right). Lift Socket cover on the side of Control Pack to attach remote cord.

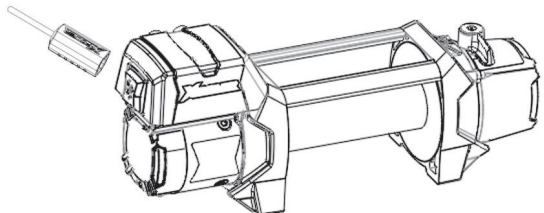

13. Operate the pendant controls briefly to ensure they work properly. If operation is reversed, the power cables may be connected backwards. Correct any such issue before use.

14. Activate the Wireless Remote by pressing the WIRELESS button until the BLUE LED is lit up. Press IN or OUT to operate winch. To turn off the Remote, Press the WIRELESS button for approximately 3 seconds to turn remote off. The Remote will automatically power off in 10 minutes if it is not used.

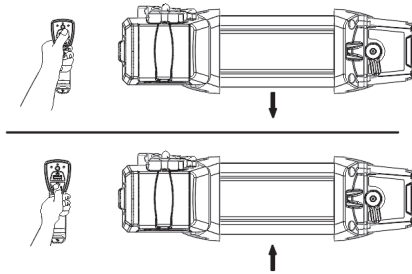

⚠ WARNING

Only operate the winch while the winch, line, and load are in view. Make sure that there are no bystanders nearby.

15. When it is safe to do so, use the power switch on the pendant controller to retract the rope, and winch the item as desired. Do not power the hook all the way into the fairlead to prevent damage.



16. Do not operate the winch at extreme angles. Do not exceed the angles shown below for a roller fairlead. For a hawse fairlead, the angle should be as close to straight as possible.

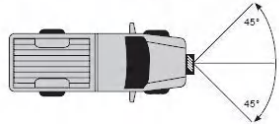

17. If the object to be pulled must be pulled at an angle in relation to the winch, use a pulley (sold separately) and an anchor point directly in front of the winch, as shown in the following picture.

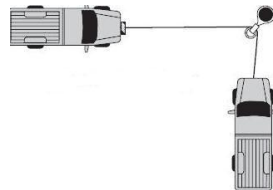

⚠ WARNING

Stop the winch and release tension on the rope before moving the cloth or canvas placed on it.

18. Discontinue use of the winch if the battery becomes weak or run down.
 19. You may wish to keep the engine running while using this winch to continually recharge the battery. However, exercise extreme caution when working around a running vehicle and ONLY operate a vehicle in an outdoor area.
 20. When finished pulling the load, reverse the direction of the winch just enough to release tension on the rope so that you can unfasten the hook from the load and reel in the rope.

Duty Cycle (Duration of Use):

Avoid damage to the winch by not winching for more than the prescribed duty cycle time. The Duty Cycle defines the amount of time, within a 15 minute period, during which a winch can operate at its maximum capacity without overheating.

For example, this winch with a 5% duty cycle at 65% maximum load must be allowed to rest for at least 14 minutes, 15 seconds after every 45 seconds of continuous operation. Failure to carefully observe duty cycle limitations can easily over-stress a winch, causing premature winch failure. Do not attempt to pull full rated load for more than 20 seconds. Release Power-In switch immediately when winch drum/rope stops. Allow winch to cool and change rigging as needed before continuing pull.

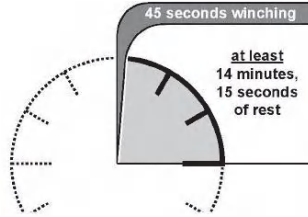

After Each Use

- Inspect rope for damage. Replace immediately if damaged.
- Power winch in to wrap rope on winch drum neatly. Watch rope carefully to make sure rope is spooled evenly onto the drum to avoid damage to winch structure or mounting plate.
- Wipe external surfaces of the winch with a clean cloth.
- Make sure the Remote Control is turned off before stowing. It will automatically go to standby/off mode after 10 minutes of inactivity.
- Store the Remote Control in a secure location in the vehicle such as the glove box or cargo container.

Maintenance

⚠ WARNING

- To prevent serious injury, disconnect the battery cables before performing any inspection, maintenance, or cleaning procedures.
- To prevent serious injury from winch failure, do not use damaged equipment. If an abnormal noise or vibration occurs, have the problem corrected before further use.
- When operating a steel cable winch, be sure to check and maintain cable. Maintenance may include lubricating rope occasionally with a light oil.
- The winch's internal mechanism is permanently lubricated. Do not open the housing. However, if the winch is submerged, it should be opened, dried, and re-lubricated by a qualified technician as soon as possible to prevent corrosion.

Rope Inspection and Care:

Wire Ropes

- Inspect the rope before and after each use. Replace rope if it has broken wires, kinks, heavy corrosion, or other damage.
- Rope can be cleaned with low pressure jetted water. Allow to thoroughly dry before covering winch.
- Light mineral oil can be applied to steel ropes to minimize corrosion.

Synthetic Rope

- Inspect the rope before and after each use. Replaced rope if it is damaged in any way as shown in images below.

Rope with Original Bulk - No Damage -	Showing Full Strand - No Damage -	Displaying 25% strand volume reduction REPLACE	Displaying multiple cut strands REPLACE	Abrasion Damage 25% Volume reduction - REPLACE

- Rope can only be cleaned with low pressure water from typical garden hose and spray nozzle. Never use chemicals to clean the rope. Clean salt residue and other debris from the winch and rope periodically.

Troubleshooting

⚠ WARNING

- Follow all safety precautions whenever diagnosing or servicing the tool.
- Disconnect power supply before service.

Use the table below to troubleshoot problems before contacting service personnel or your local dealer. If the problem continues after troubleshooting, call your local dealer for assistance.

Failure	Possible Cause	Corrective Action
Motor overheats	<ol style="list-style-type: none"> 1. Incorrect power cords 2. Winch is being over-worked 	<ol style="list-style-type: none"> 1. Use only supplied power cords 2. Allow winch to cool down periodically
Motor does not turn on	<ol style="list-style-type: none"> 1. Switch assembly not connected properly. 2. Loose battery cable connections 3. Vehicle battery needs charging 4. Solenoid malfunctioning 5. Defective switch assembly 6. Defective motor 7. Water has entered motor 8. Internal damage or wear 	<ol style="list-style-type: none"> 1. Insert switch assembly all the way into connector. 2. Tighten nuts on all cable connections 3. Fully charge battery 4. Tap solenoid to loosen contacts. Apply 12 volts to coil terminals directly. A clicking indicates proper activation 5. Replace switch assembly 6. Check for voltage at armature port with switch pressed. If voltage is present, replace motor 7. Allow to drain and dry. Run in short bursts without load until completely dry 8. Have technician service winch
Motor runs but rope drum does not turn	The clutch is not engaged	Move the Clutch Handle to the Engaged position. If problem persists, contact a qualified technician to check and repair unit.
Motor runs slowly or without normal power	<ol style="list-style-type: none"> 1. Insufficient current or voltage 2. Loose or corroded battery cable connections 3. Incorrect power cords 	<ol style="list-style-type: none"> 1. Battery weak, recharge Run winch with vehicle motor running 2. Clean, tighten, or replace 3. Use only supplied power cords
Motor runs in one direction only	<ol style="list-style-type: none"> 1. Defective or stalled solenoid 2. Defective switch assembly. 	<ol style="list-style-type: none"> 1. Tap solenoid to loosen contacts. Or repair / replace the solenoid 2. Replace switch assembly

Replacement Parts

- For replacement parts and technical questions, please contact Customer Service at **1-888-380-7428**.
- Not all product components are available for replacement. The illustrations provided are a convenient reference to the location and position of parts in the assembly sequence.
- When ordering parts, the following information will be required: item description, item model number, item serial number/item lot date code, and the replacement part number.
- The distributor reserves the rights to make design changes and improvements to product lines and manuals without notice.

Parts Diagram

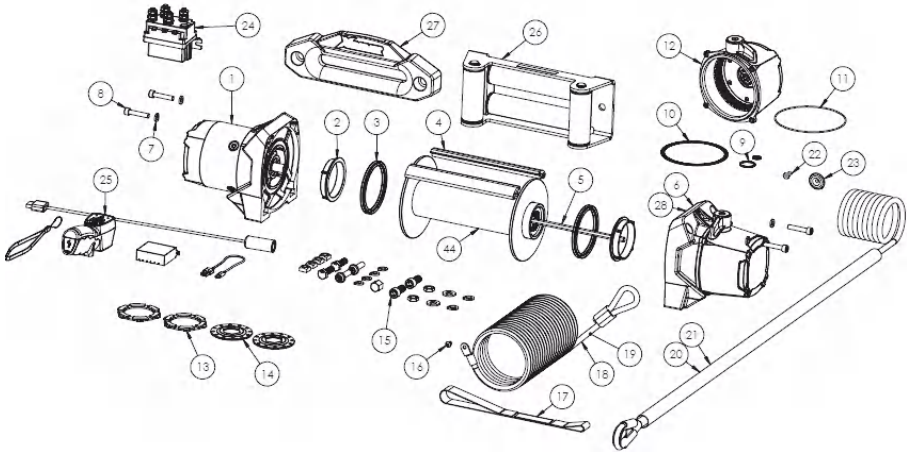

Parts List:

MODEL:		XP-12	XP-12s	XP-10	XP-10s
Service Kit Description	Items in Kit *	All part number start with FUS-1080			
KIT SVC ASSY MOTOR MF G2	1	2000-0032	2000-0032	2000-0032	2000-0032
KIT SVC ASSY GEARBOX 12K MF G2	6	2000-0028	2000-0028		
KIT SVC ASSY GEAR HOUSING MF G2	12	2000-0029	2000-0029	2000-0029	2000-0029
KIT SVC DURM + D SEAL + TIE RODS 12K G2	3, 4, 44	2000-0030	2000-0030	2000-0030	2000-0030
KIT SVC SEALS + BUSHINGS MF G2	3, 4	2000-0031	2000-0031	2000-0031	2000-0031
KIT SVC HARDWARE MF G2	7, 8, 15	2000-0041	2000-0041	2000-0041	2000-0041
KIT SVC BRAKE MF G2	13, 14	2000-0042	2000-0042	2000-0042	2000-0042
KIT SVC ASSY SHAFT DRIVE MF G2	5	2000-0033	2000-0033	2000-0033	2000-0033
KIT ACC REMOTE WIRELESS MF G2	25	2000-0034	2000-0034	2000-0034	2000-0034
KIT SVC ASSY GEARBOX 10K MF G2	28			2000-0035	2000-0035
KIT SVC CONTACTOR MF G2	24	2000-0036			
KIT SVC ROPE 3/8" X 79' 7x19 AWR MF G2	16, 18	2000-0025			
KIT SVC ROPE 10mm x 79' SYNTHETIC MF G2	20, 22, 23		2000-0026		
KIT SVC ROPE 9mm x 82' 7x19 AWR MF G2	16, 19			2000-0027	
KIT SVC ROPE 3/8" x 82' SYNTHETIC MF G2	21, 22, 23				2000-0037
KIT SVC FAIRLEAD ROLLER MF	26	2200-0005		2200-0005	
KIT SVC FAIRLEAD HAWSE MF	27		2200-0006		2200-0006
KIT SVC CONTROL PACK MF INT (w/Remote)	NOT SHOWN	2200-0007	2200-0007	2200-0007	2200-0007
KIT SVC CONTROL PACK MF NI (w/Remote)	NOT SHOWN	2200-0008	2200-0008	2200-0008	2200-0008

NOTE: * All kits contain part quantity needed to service one winch



WARRANTY FORM LIMITED LIFE WARRANTY

Effective April 28th 2020.

Warranty Qualifications

X-Power will register this warranty upon receipt of your Warranty Registration Card and a copy of your Warranty Registration Card and a copy of your dated sales receipt and original bill of sale clearly showing the X-Power Product purchased.

Product cover by this warranty

XP Mid-Frame Winches

Repair/ Replacement Warranty

X-Power warrants to the original purchaser that the mechanical and electrical components will be free of defects in material and workmanship for Limited Lifetime (parts and labor) from the original date of purchase. Transportation charges on product submitted for repair or replacement under this warranty only applies to the original purchaser and is not transferable.

Do not return the unit to the place of purchase

Contact X-Power Technical Serviced X-Power will troubleshoot any issue via phone or e-mail. If the problem is not corrected by this method, X-Power will, at its option, authorize evaluation, repair or replacement of the defective part or component at a X-Power service center. X-Power will provide you with a case number for warranty service. Please keep it for future reference. Repairs or replacements without prior authorization, or at an unauthorized repair facility, will not be covered by this warranty

Phone: 888-380-7428

Email: parts@uriahproducts.com

Items covered by this warranty

Electric components covered by the seven (7) year Limited Warranty: motor, contactor, solenoid, handheld remote control, wiring.

All other mechanical components are covered by the Limit Lifetime Warranty except as listed below.

Normal Wear

Product with mechanical and electrical components need periodic parts and service to perform well. This warranty does not cover repair normal use has exhausted the life of a part or the equipment as a whole, such as winch cable, bearings, bushings, seals, gaskets, brake material, motor brushes, electric cable, etc.

Installation, Use and Maintenance

This warranty will not apply to parts and/or labor if the product is deemed to have been misused, neglected, involved in an accident, abused, loaded beyond the product's limits, modified installed improperly or connected incorrectly to any electrical component. Normal maintenance is not covered by this warranty and is not required to be performed at a facility or by a person authorized by X-Power.

Other exclusions

The warranty excludes the following:

- Cosmetic defects such as product finish, etc.
- The removal or reinstallation of the product,
- Accessory parts such as storage covers
- Commercial or industrial use or application, or any hoisting application of the product
- Failures due to acts of God and other force majeure events beyond the manufacturer's control.
- Problems caused by part that are not original X-Power part.

Limited of implied warranty and consequential damage

X-Power disclaims any obligation to cover any loss of time, use of this product, freight, or any incidental or consequential claim by anyone from using this product.

THE WARRANTY SET FORTH ABOVE IS THE ONLY WARRANTY. THERE ARE NO OTHER WARRANTIES, EXPRESS OR IMPLIED, INCLUDING BUT NOT LIMITED TO IMPLIED WARRANTIES OF MERCHANTABILITY OR FITNESS FOR A PARTICULAR PURPOSE.

ANY IMPLIED WARRANTY WHICH BY LAW MAY NOT BE EXCLUDED, IS LIMITED IN DURATION TO ONE (1) YEAR FROM THE DATE OF ORIGINAL RETAIL PURCHASE OF THE PRODUCT.

X-POWER SHALL NOT BE LIABLE FOR SPECIAL, INDIRECT, INCIDENTAL OR CONSEQUENTIAL DAMAGES (INCLUDING BUT NOT LIMITED TO, LOST PROFITS, DOWN TIME OR LOSS OF USE) UNDER ANY LEGAL THEORY, EVEN IF X-POWER WAS ADVISED OF THE POSSIBILITY OF SUCH DAMAGES.

A unit provided as an exchange will be subject to the warranty of the original unit. The length of the warranty governing the exchanged unit will remain calculated by reference to the purchase date of the original unit.

This warranty gives you certain legal rights which may change from, state to state or province. Your state or province may also have other rights you may be entitled to that are not listed within this warranty.

X-Power reserves the right to change product design without notice. In situations in which X-Power has changed a product design, X-Power shall no obligation to upgrade or otherwise modify previously manufactured products.

No X-Power dealer, agent or employee is authorized to make any modification, extension or addition to this warranty



Distributed by:

Uriah Products
2720 North Commerce Drive, Ave.
Springfield, MO 65803
Call: 888-380-7428
+8602154885106