









Amish Cool

ASSEMBLY INSTRUCTION

-  A M4. 0*90 26PCS+1
-  B M4. 0*60 6PCS+1
-  C M3. 5*35 41PCS+1
-  D M3. 5*30 5PCS+1
-  E M3. 0*16 21PCS+1
-  F M3. 0*25 6PCS+1
-  G 2PCS
-  H 2PCS

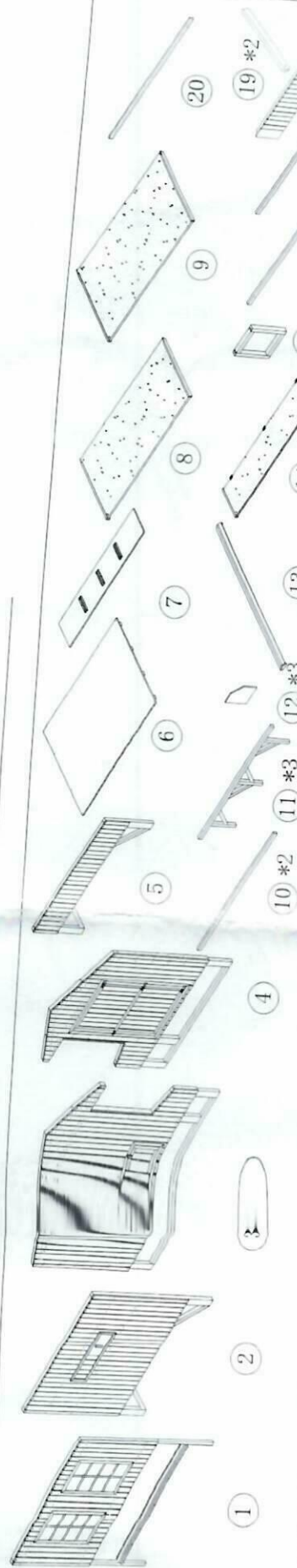

C M3. 5*35 2PCS

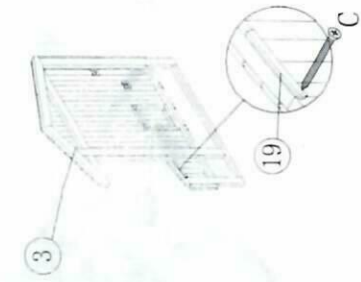

STEP 1

C M3. 5*35 7PCS

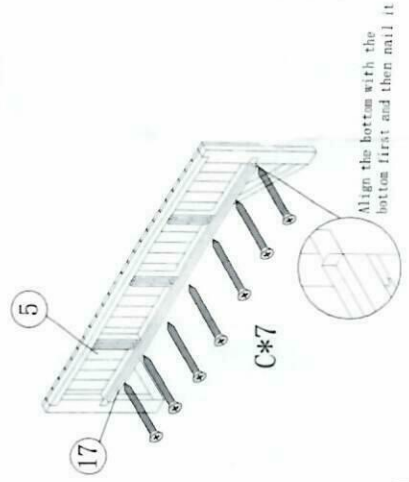

STEP 4

C M3. 5*35 7PCS

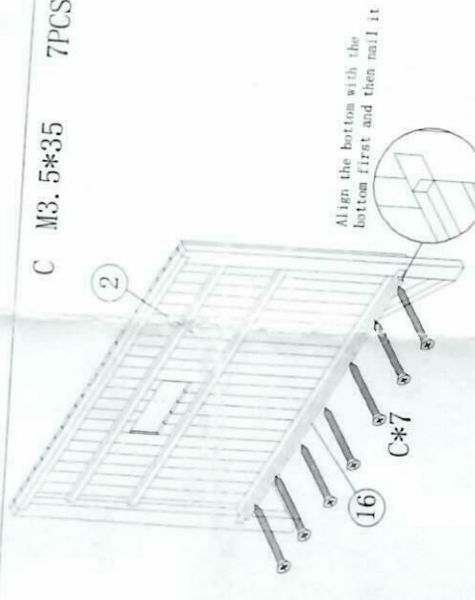

STEP 2

A M4*90 8PCS

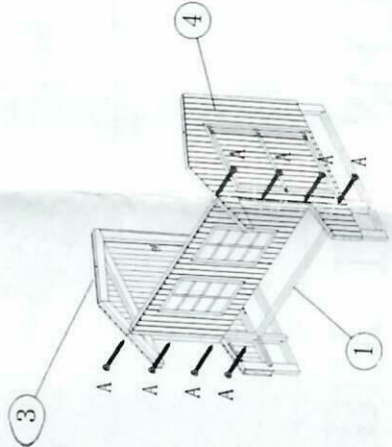

STEP 5

C M3. 5*35 7PCS

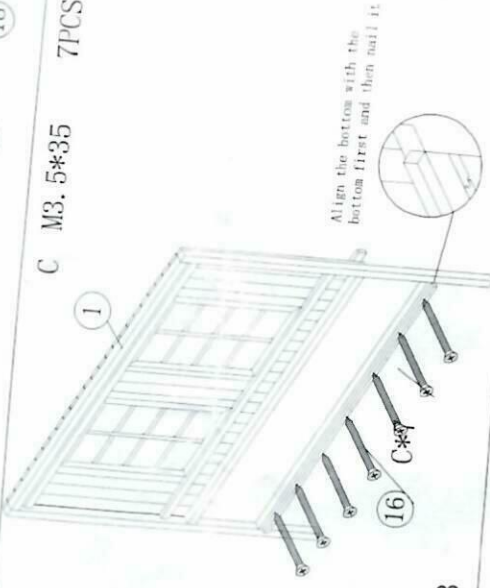

STEP 3

A M4*90 6PCS

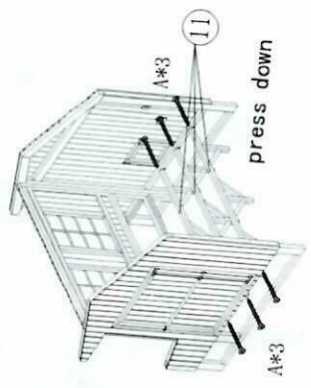

STEP 6

ASSEMBLY INSTRUCTION

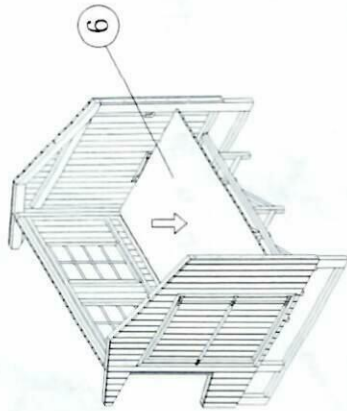

STEP 7

C M3.5*35 7PCS

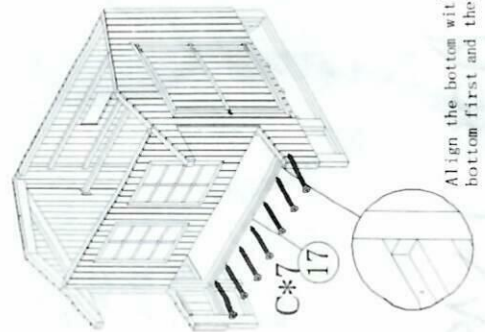

STEP 10

Align the bottom with the bottom first and then nail it



STEP 8

C M3.5*3 3PCS



STEP 11

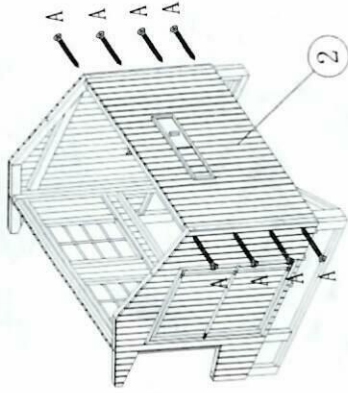

STEP 9



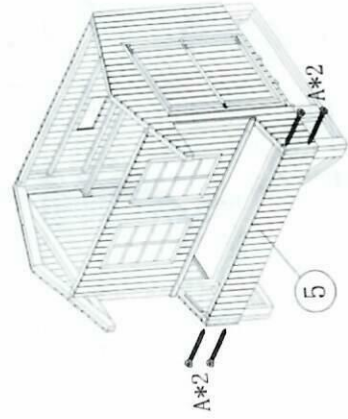

A M4*90 4PCS

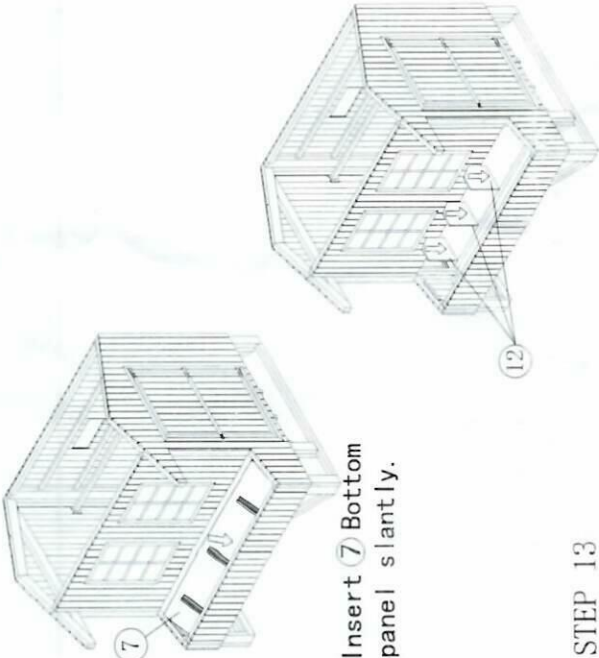

STEP 12

A M4*90 8PCS

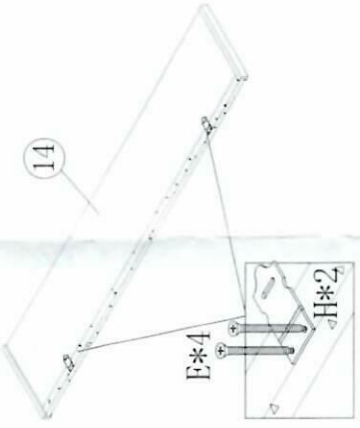
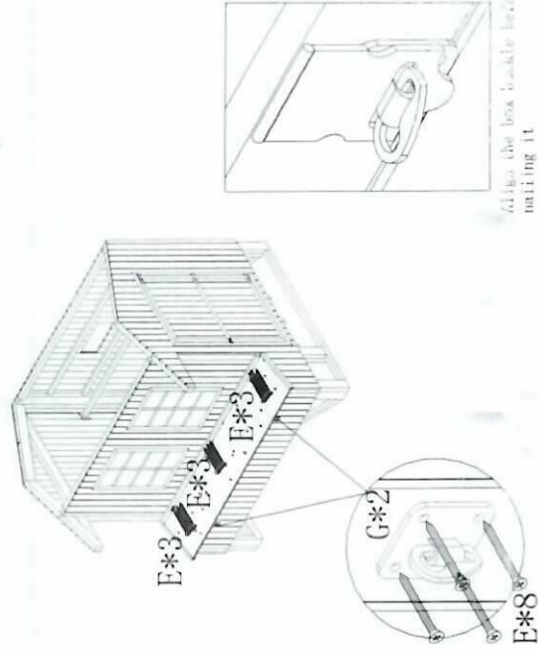
ASSEMBLY INSTRUCTION

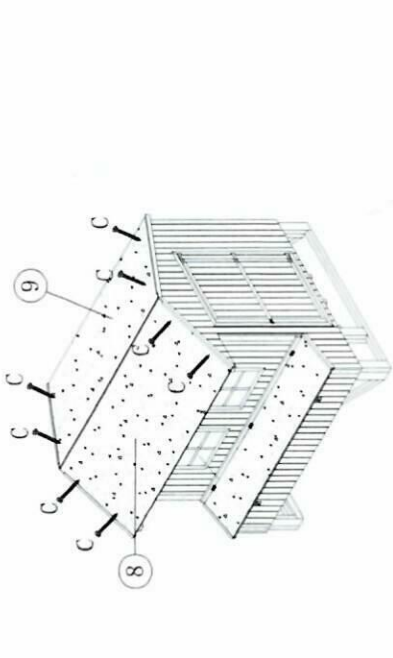
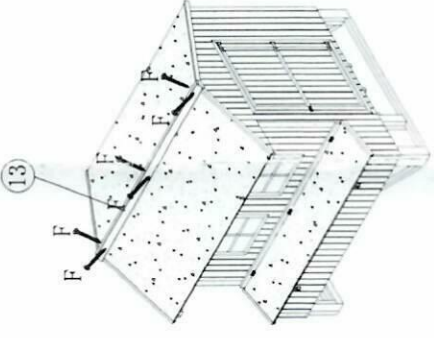
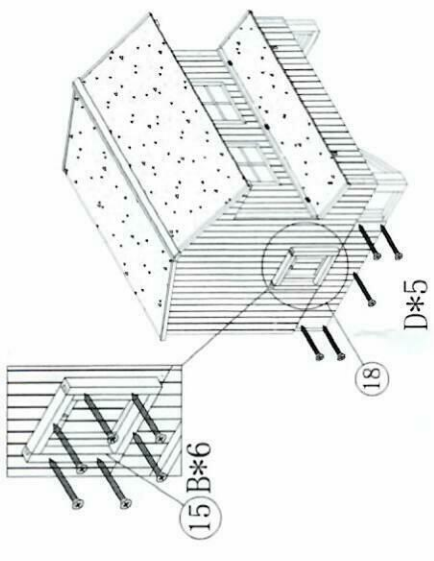
 <p>Insert 7 Bottom panel slantly.</p> <p>STEP 13</p>	<p>H  2PCS</p>  <p>E M3.0*16 4PCS</p> <p>STEP 14</p>	<p>E M3.0*16 17PCS</p>  <p>G  2PCS</p> <p>STEP 15</p> <p><i>Fix the box buckle bracket using it.</i></p>
<p>C M3.5*35 8PCS</p>  <p>STEP 16</p>	<p>F M3.0*25 6PCS</p>  <p>STEP 17</p>	<p>D M3.5*30 5PCS</p>  <p>B M4.0*60 6PCS</p> <p>STEP 18</p>

1871

1872

1873

1874

1875