

Item No: 705 Electric Ride-On

Installation & operation Manual

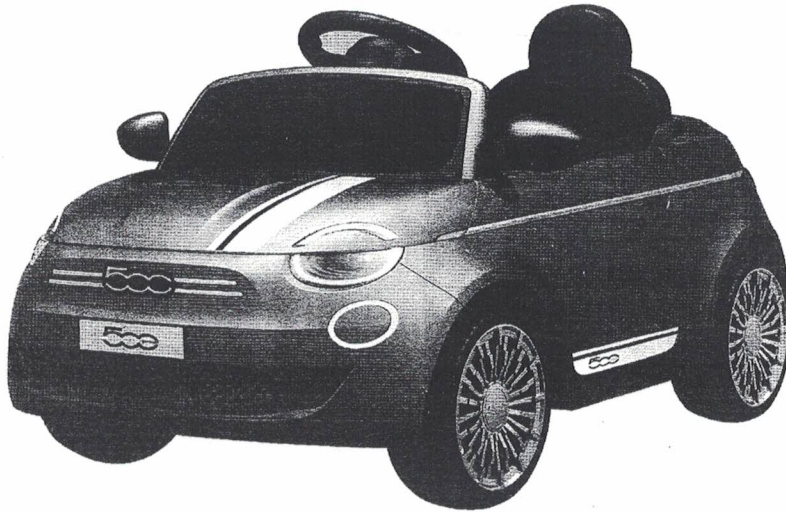

CAUTION:

- This package contains small parts
- Adult assembly required
- Remove all plastic bags and package ties prior to giving to children
- Protective equipment recommended
- Not to be used in traffic
- Keep this instructions for future reference



WARNING











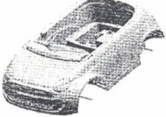

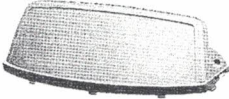
**ADULT ASSEMBLY
REQUIRED.**

"FIAT" and "500e" are trademarks of and under license of
FCA Italy S.p.A. and/or FCA Group Marketing S.p.A.

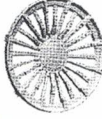
I.SPECIFICATIONS.

Suitable Ages	3-6 years
Product Dimensions	100x60x50 cm
Maximum Weight	30 kgs
Speed	3-3.2km/h
Motor	30W
Charger	DC 6V500mA/12V700mA
Battery	6V4.5AH/12V4.5AH
Remote Control	2.4G one to one function
Remote Control Batteries	2XAAA Size(not included)
Steering Wheel Batteries	2XAA Size(not included)
Operating Ambient Temperature	0-40°C

II.Components List.

<p>1.Car body 1pc</p> 	<p>2.Steering wheel 1pc</p> 	<p>3.Seat 1pc</p> 
<p>4.Windshield 1pc</p> 	<p>5.Rear-view mirror 2pcs</p> 	<p>6.Front wheel 2pcs</p> 
<p>7.Rear wheel 2pcs</p> 	<p>8.Wheel cap 4pcs</p> 	<p>9.Cotter pin 5pcs (1 replacement piece)</p> 
<p>10.Washer 7pcs (1 replacement piece)</p> 	<p>11.Remote control 1pc</p> 	<p>12.Audio connecting wire 1pc</p> 
<p>13.Charger 1pc</p> 	<p>14.Spacer 1pc(only for single motor model)</p> 	

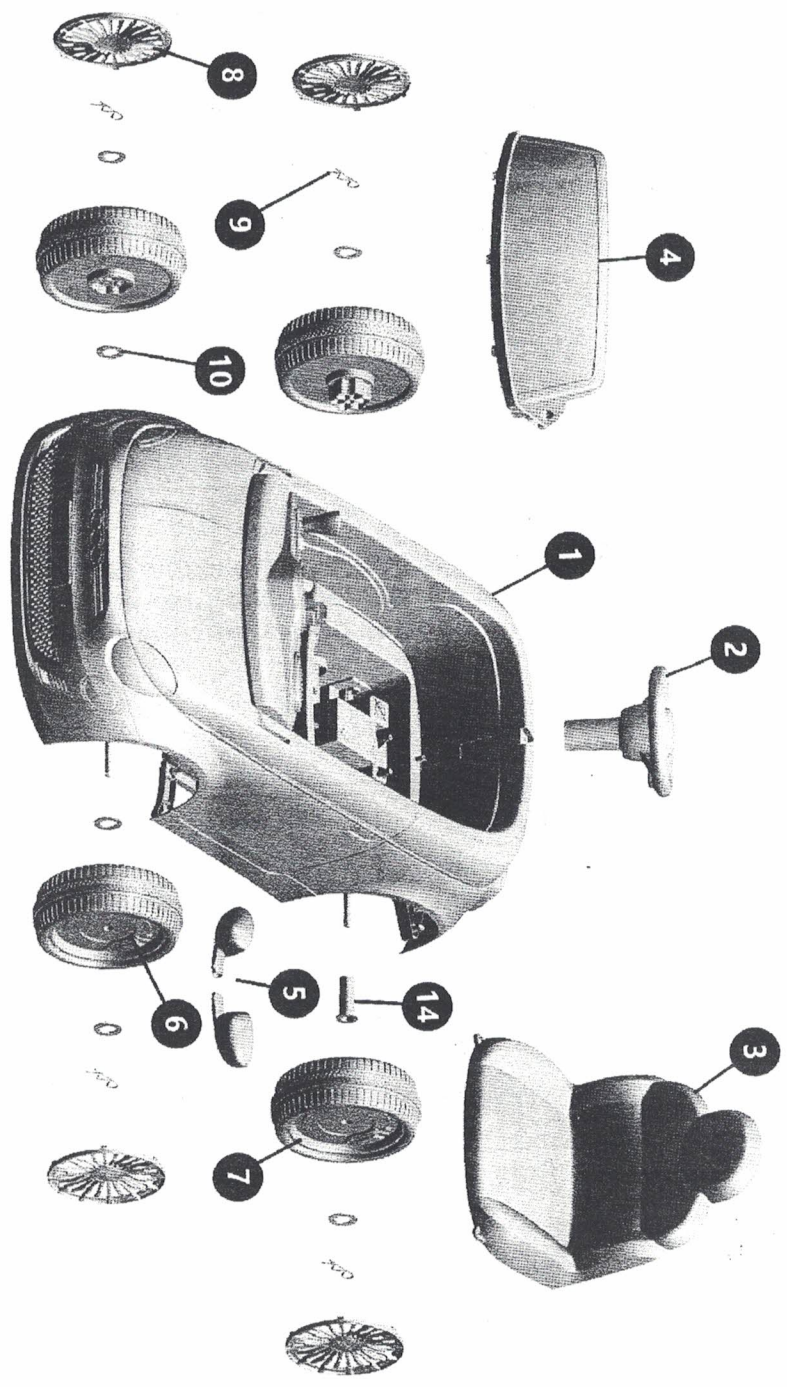

III. Assembly Instructions.

<Step1-1>

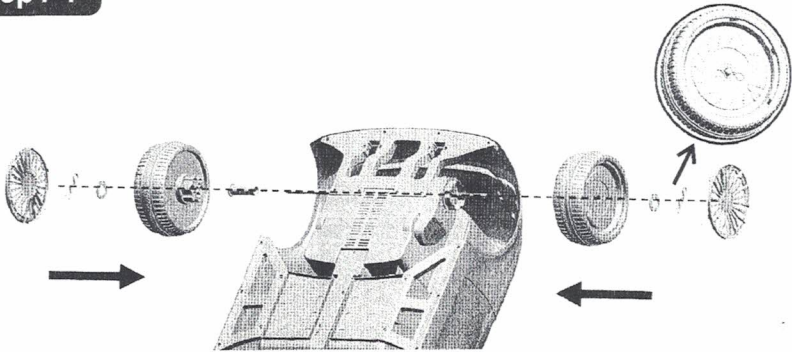

1-1 (Only for single motor) Insert the spacer from the left into the rear axle, then insert the two rear wheels, tighten using a washer and a cotter pin, cover the wheel caps at the end.

<Step1-2>

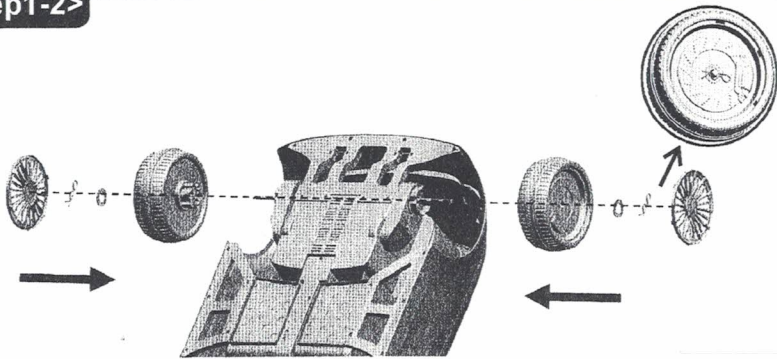

1-2 (only for dual motors) Insert the two rear wheels, tighten using a washer and a cotter pin, then cover the wheel caps.

<Step 2>

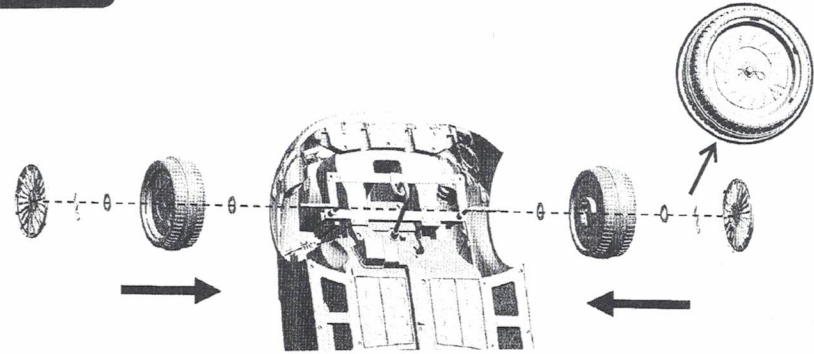

2. Insert the two washers first together with the two front wheels, tighten using a washer and a cotter pin, then cover the wheel caps.

<Step 3>

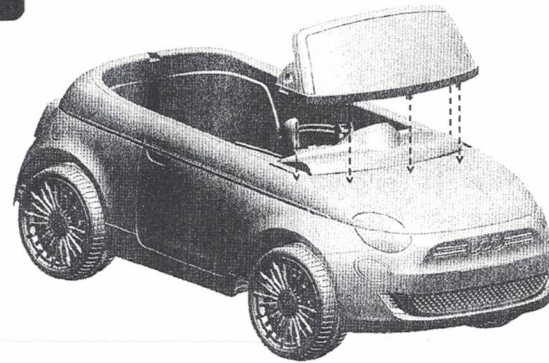

3. Insert the windshield in the front of the car body, make sure it is firmly fixed.

<Step 4>

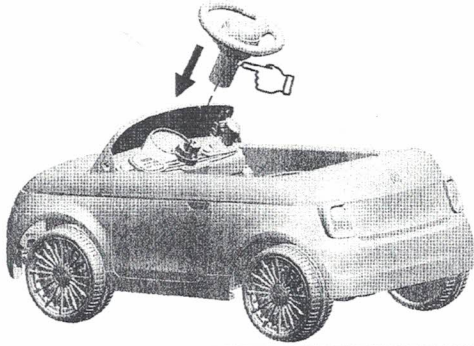

4. Press the button and insert the steering wheel.

<Step 6>

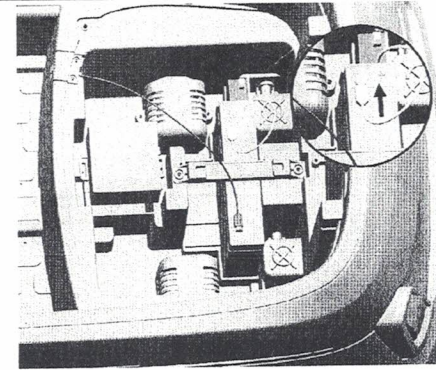

6. Insert the RED cable terminal into the battery positive pole.

<Step 5>

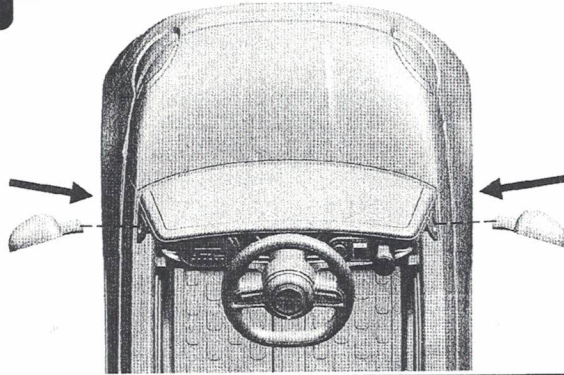

5. Insert the two rear-view mirrors into the car body, make sure it is firmly fixed.

<Step 7>

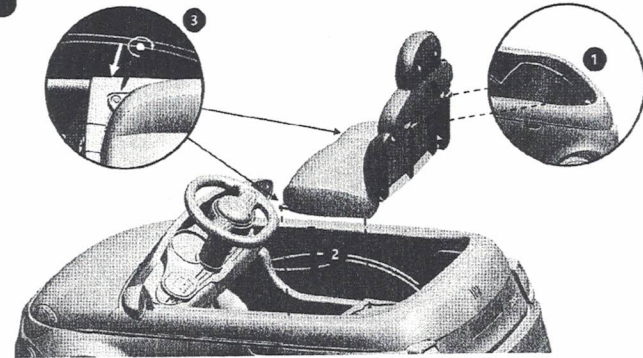

7. Place the seat into the car body, then tighten by two screws with a screwdriver(not included).

IV. BATTERY CHANGE

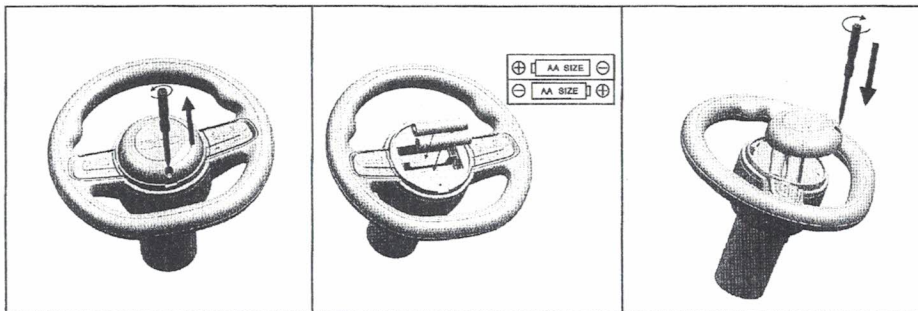

V. Function and Operation.

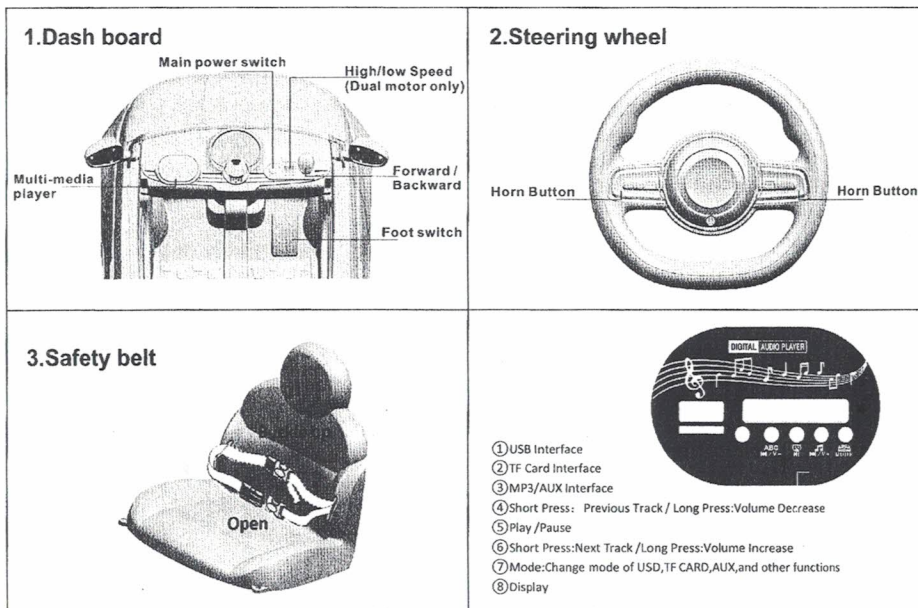

VI. Charging the Drive Battery

1. The charging socket is located at the lower part of the car seat.
2. Only battery and charger which are provided or recommended can be used only.
3. Please do not play with the charger and battery because they are not toys.
4. The battery charging operation is to be carried out only by adults.
5. The battery shall be fully charged before first use; the battery charging time shall be 9-10 hours and can not exceed 15 hours
6. It is normal for battery and charger to feel warm during charging.

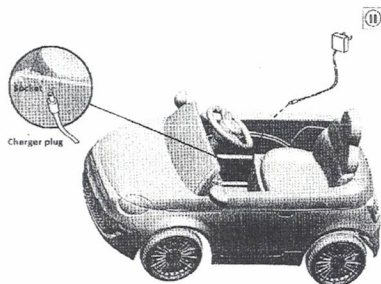

VII. Simple Problem Diagnostic.

Defective conditions	Key points of inspection
1. The car can not be driven.	1) Ensure the power switch, all plugs of the control plate under the seat, and the battery terminal line are properly inserted.
	2) Ensure the over current protector, when the car is over loaded or blocked, the over current protector automatically disconnects the circuit to protect the motor and controlling IC board.
	3) Check whether the car has been stored for a long time and its battery is not charged on time.
	4) If the remote control cannot start the car, please check whether the remote control code-matching function is normally operated.
	5) Check whether the remote control battery power is low.
2. Music sound is distorted or silent	Check whether the battery has enough power, otherwise charge fully.

VIII. WARNING.

1. Battery warning:

- 1) When storing the car for long period of time, charge the battery until full then turn off the power switch. The battery should be recharged once every other month, or may otherwise have a shorter life span and risk deteriorating.
- 2) When installing the battery, it is important that the positive and negative poles are correctly connected. Short circuiting of positive and negative poles may result in damaging the toy.

Battery warning:

- 1) Product needs to be operated with two DC 1.5V AAA batteries (not included) and two DC 1.5V AA batteries(not included).
- 2) Battery charging is recommended only to be done by adults.
- 3) Rechargeable batteries charging operation can be carried out only by adults.
- 4) Non-rechargeable batteries cannot be charged.
- 5) The rechargeable batteries can be charged only after being taken out from the remote control battery compartment.
- 6) Please do not mix different types of batteries or used batteries and new batteries.
- 7) If product will be stored for a long time, it is recommended to remove batteries from battery compartment.
- 8) Over used batteries should be removed from toy.

2. Product warning:

- 1) There may be potential sharp edges, sharp points or small parts before the assembly of this product, and therefore this product shall be assembled by the adult.
- 2) To avoid suffocation, keep the plastic bag away from children. Dispose of all bags immediately.
- 3) Children shall use the car under adult guidance and supervision to prevent risk of injury.
- 4) The car is suitable for being driven on the flat ground and strictly prohibited to be driven in dangerous places such as public roads, slope and near swimming pool to prevent traffic and drowning accidents.

- 5) Please put on shoes and take protective measures before use, such as fastening the safety belt and putting on the helmet, gloves, knee pads, etc.
- 6) Not suitable for children under 36 months as parts may fall off when used improperly.
- 7) Regularly check whether the battery, charger, wire, plug, casing and other parts are damaged; if the damage occurs, please cease to use this product until it has been repaired.
- 8) This product is only allowed to be used by one child; the maximum load is 30kg, overload is not allowed.
- 9) Keep away from fire.
- 10) The product instructions shall be kept as they contain important information.

IX. Remote Control Instructions.

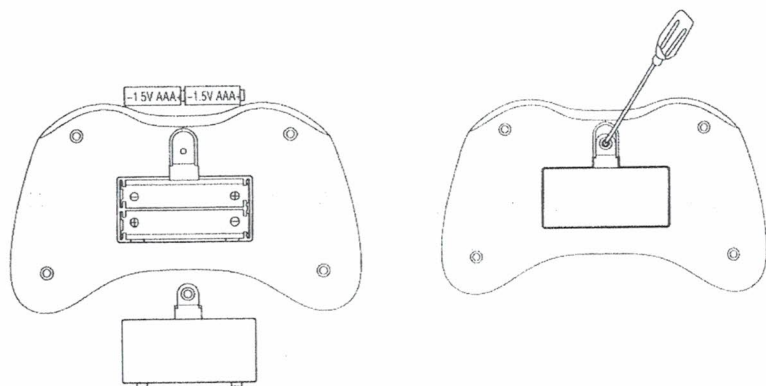

Loosen the screw with a screwdriver, and put 2 AAA batteries into the battery house.
Cover with a battery cover and tight with a screw

- ① Forward/Backward button
- ② Turn-left/right button
- ③ Sudden brake button
- ④ Speed change button
- ⑤ Frequency bind button

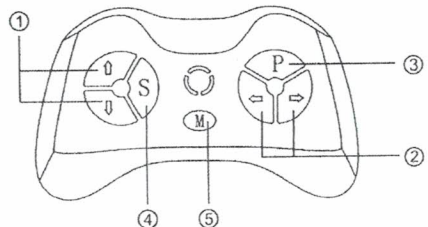

Operation manual: For the first time to use Need to frequency bind.

- Take out the remote control, install the battery
- Long press on the button "M" for 2-4 seconds, Indicator light will flash

- Turn on the power of the car, when the indicator light flashes turn to long lighting, then frequency bind is successful.
- If the frequency bind failed (Indicator light flashes), remove the battery and repeat steps 1-3.
- When remote control is not operated after 10 seconds, indicator light will turn to power saving mode.
- Button Description: Δ forward ∇ backward \triangleleft turn left \triangleright turn right: Speed P: emergency brake, when pressed, the car will come to a stand still. Press again to release break.

3. WARNING:



Adult supervision required to reduce the risk of injury;
Strictly forbidden to use on roadways, near motor vehicles, slopes or swimming pools and areas where there is water;
Please wear shoes when operating vehicle;
Can only be used by one person at a time;
Keep away from children before assembled as there may be sharp edges points or small parts.
Adult assembly required.
A reminder that the toy should be used with caution since skill is required to avoid falls or Collisions causing injury to the user or third parties.



Do not mix alkaline battery, standard (carbon-zinc) battery or rechargeable (nickel-cadmium) battery.



Protective equipment should be worn. Not to be used in traffic.



This product is not suitable for children under 3 years of age due to its maximum speed.

IX. Care and Maintenance

- 1) Regularly wipe and clean it with a piece of cloth.
- 2) The rotating parts of the car should be checked regularly to determine whether any foreign matter obstructs the rotation and to keep lubricating state of normal operation.