

SNAP LOCK

Large Coop Run

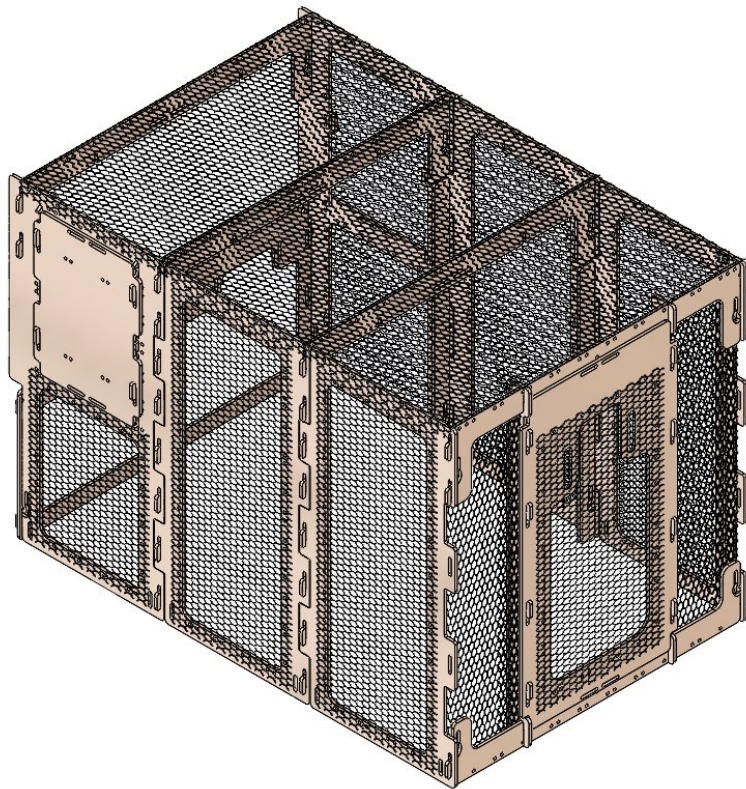

Instruction Manual
for Snap Lock Large Chicken Coop Run

PARTS LIST FOR THE LARGE SNAP LOCK CHICKEN COOP RUN

This kit for the Large Model SNAP LOCK CHICKEN COOP RUN includes the following:

- one envelope containing instructions, the warranty
- It also includes all the parts listed on this page

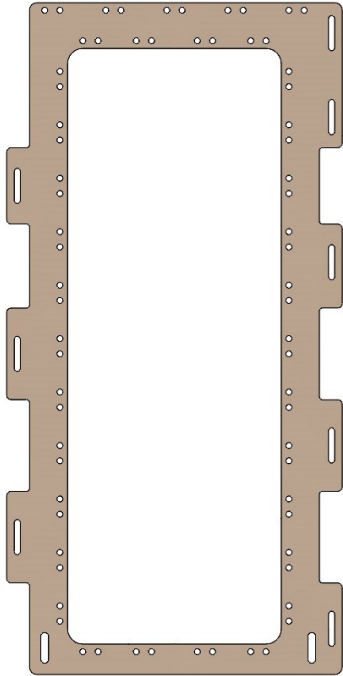

Side Panel (4)

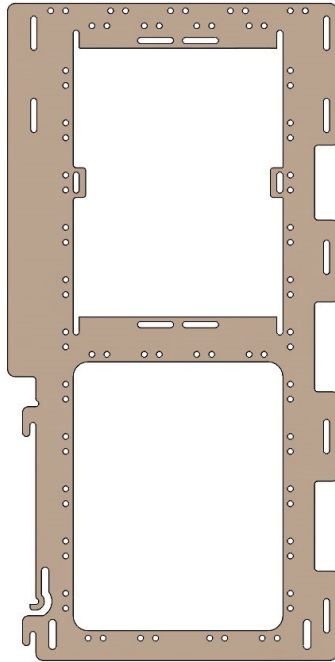

Side Panel 2 (2)

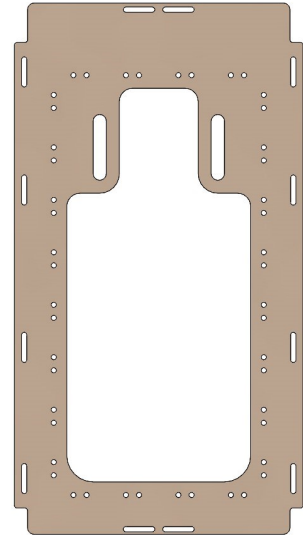

Door (1)

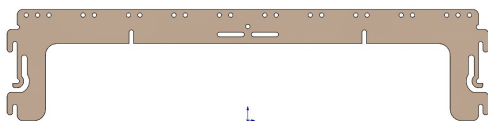

Cross Bar (4)

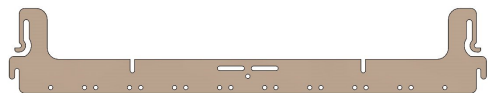

Lower Bar (1)



Side Door Frame (2)



Link Bar (4)



Door Frame (2)

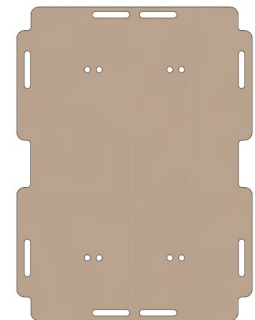

Side Door (1)

Exploded Views with Part Descriptions

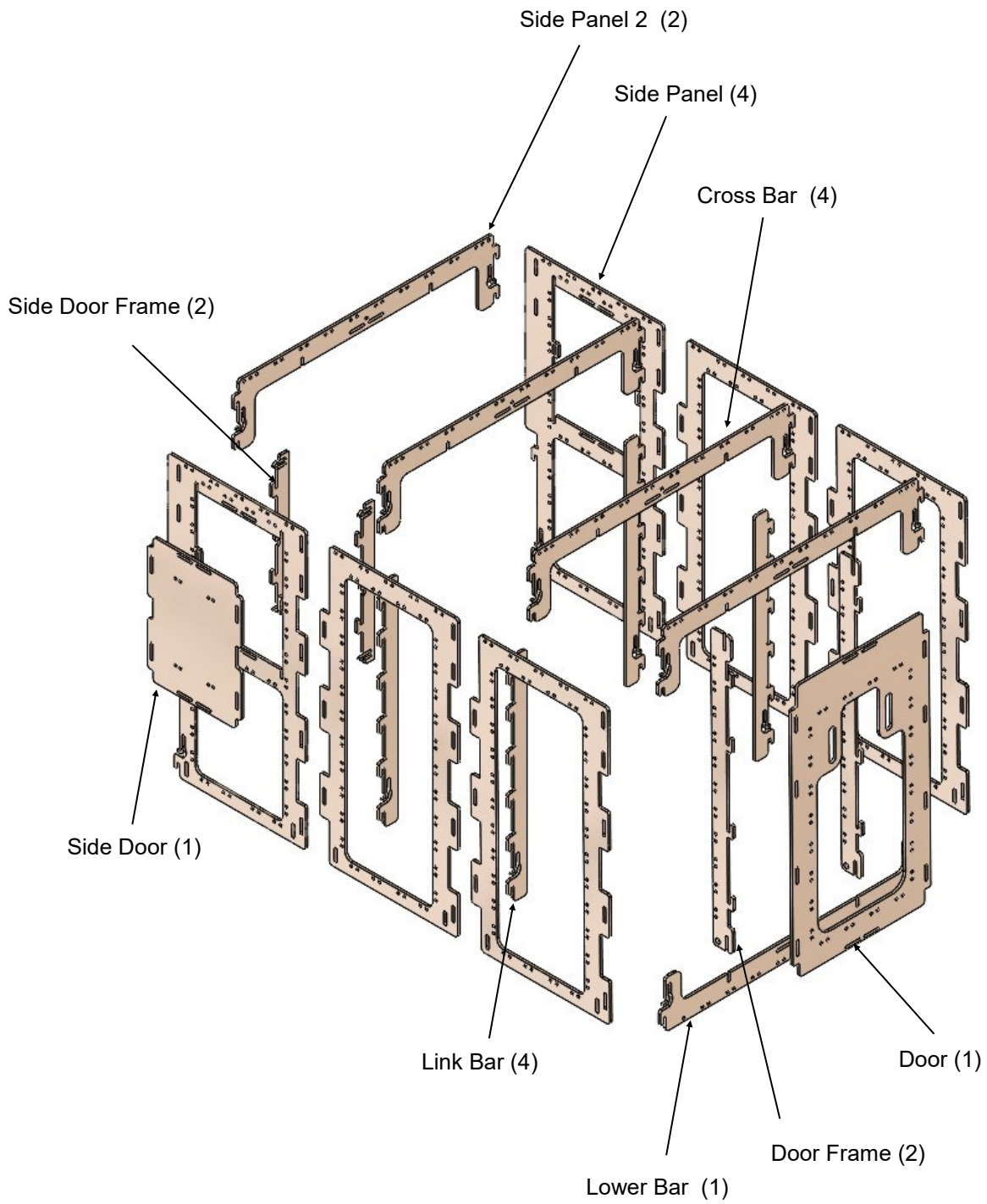

LARGE COOP RUN Assembly

Step 1: Place one side panel next to one side panel 2. Press the panels together to interlock the profiles. Insert a link bar into the aligned slots, avoiding the top two slots on the side panel 2. Press the linking bar down firmly until it clicks into place.

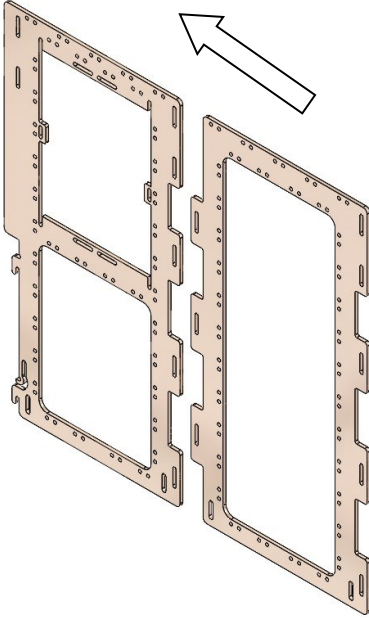

Fig. 1a

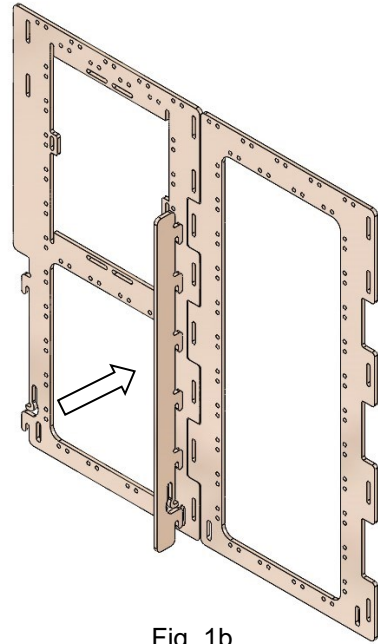

Fig. 1b

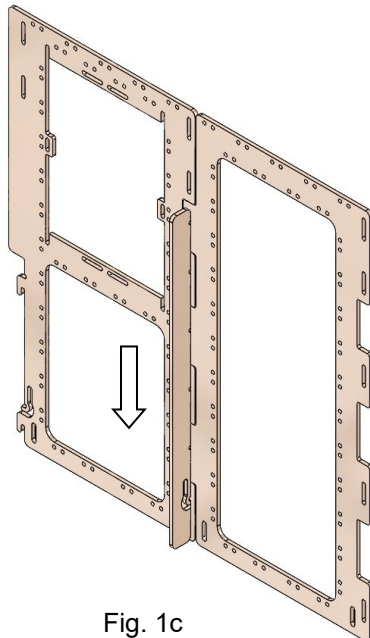

Fig. 1c

LARGE COOP RUN Assembly

Step 2: Add a second side panel to the assembly, once again matching the profiles and using a linking bar to connect the panel sections.

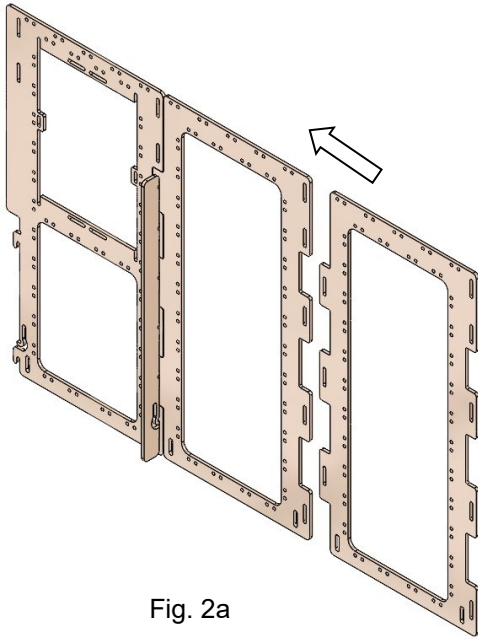

Fig. 2a

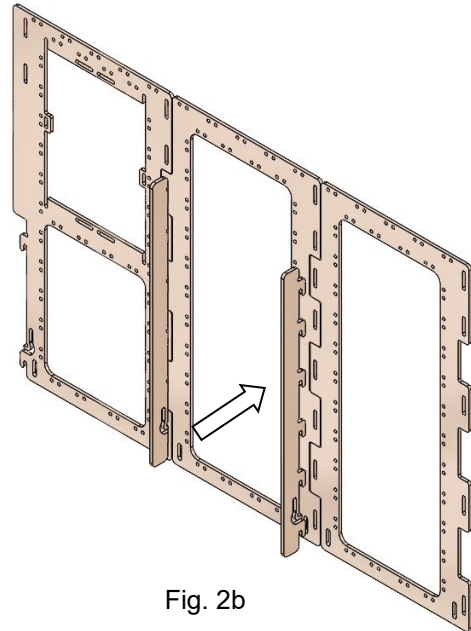

Fig. 2b

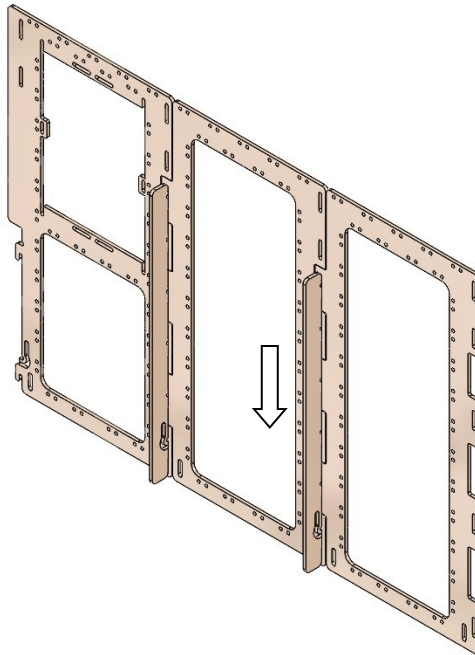

Fig. 2c

LARGE COOP RUN Assembly

Step 3: Repeat step 1 and 2 with the remaining two side panels and the last side panel 2. Place the link bar on the opposite side of the panels so it mirrors the previous assembly.

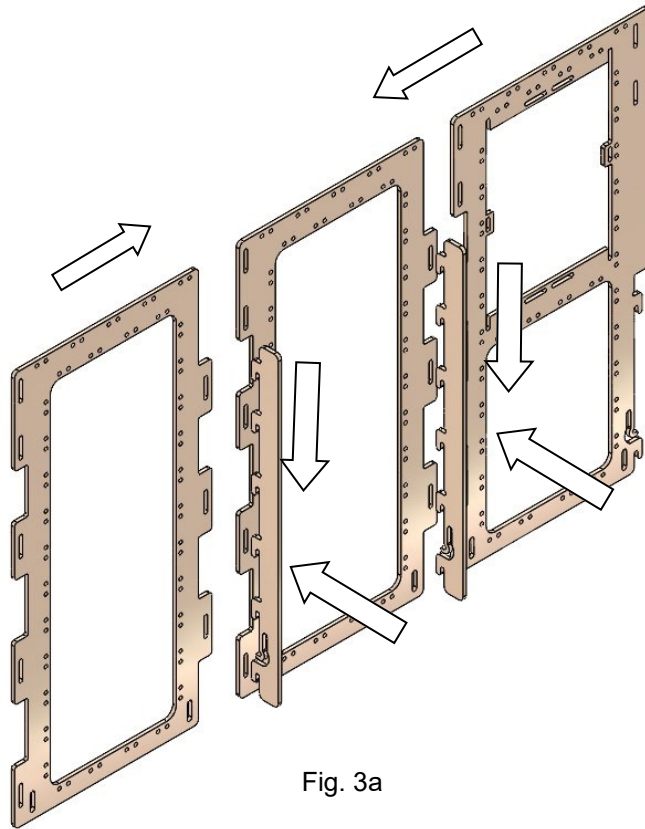

Fig. 3a

LARGE COOP RUN Assembly

Step 4: Insert the lower bar into the bottom slot of one of the two side panel assemblies. Press down until the lower bar clicks into place. Insert the two door frames into the slots on the lower bar with their tabs facing outwards. Insert one of the cross bars into the upper slots of the door frames and then into the top two slots of the side panel assembly. Press down until the cross bar clicks into place.

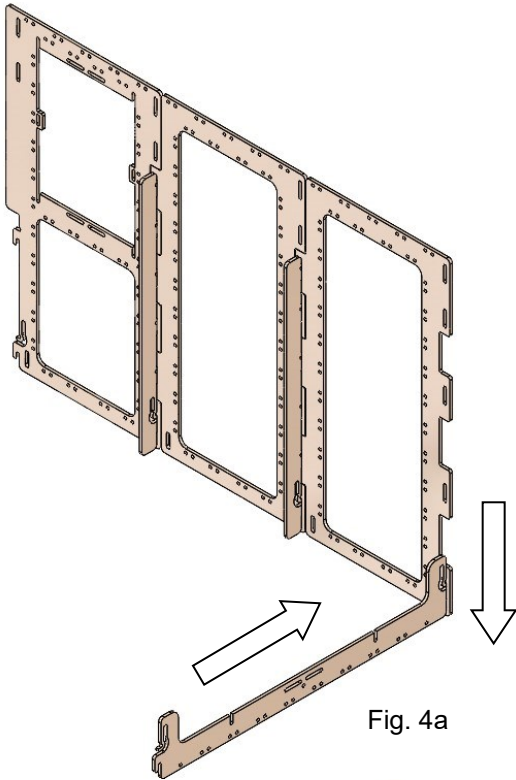

Fig. 4a

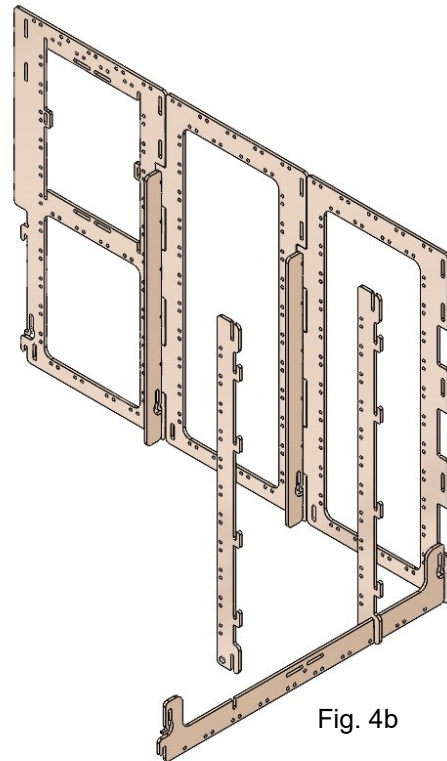

Fig. 4b

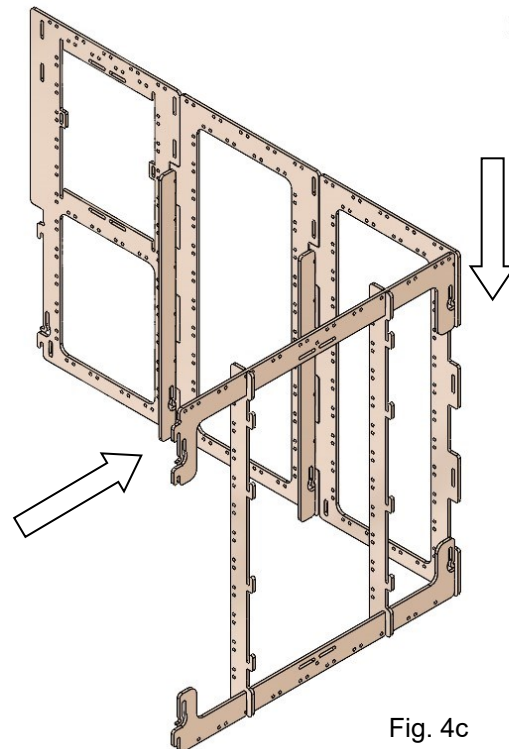

Fig. 4c

LARGE COOP RUN Assembly

Step 5: Attach the remaining cross bars by inserting them into the top slots of the side panel assembly and pressing down until they click into place. Then attach the second side panel assembly into place and pressing until the crossbars click into place again.

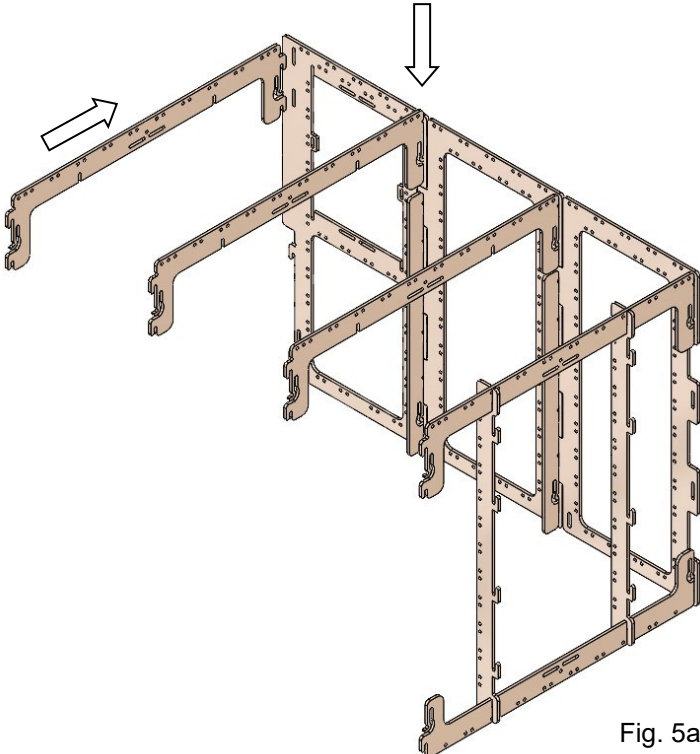

Fig. 5a

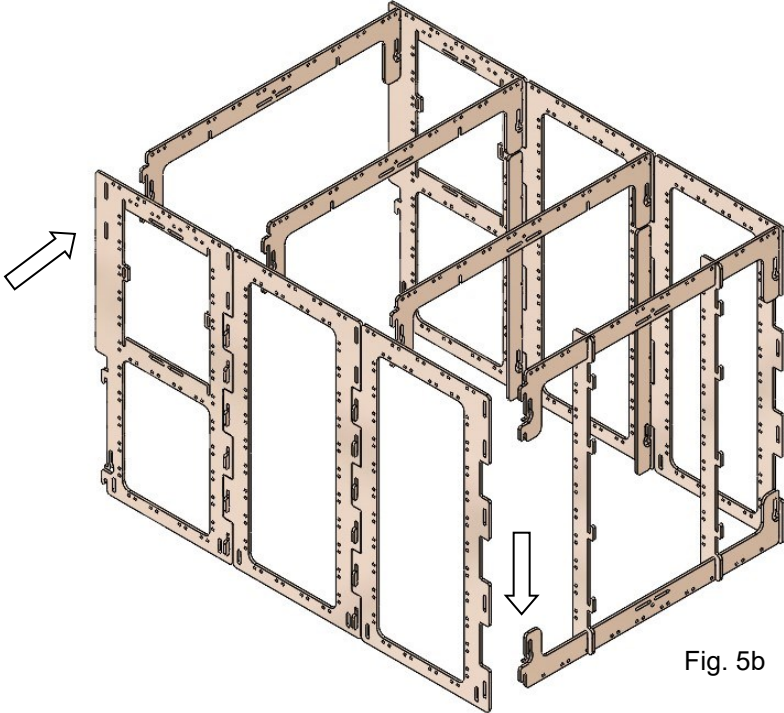

Fig. 5b

LARGE COOP RUN Assembly

Step 6: The side door can be installed either on the left or right of the run assembly. Insert both side door frames into the top opening of the chosen side panel 2 so that the tabs slide into the slots at the four corners and in the middle of each side.

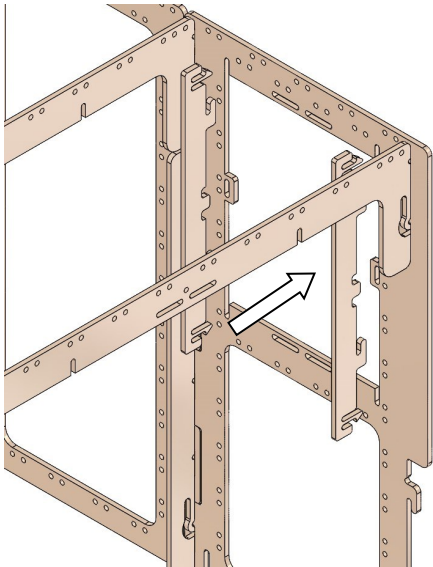
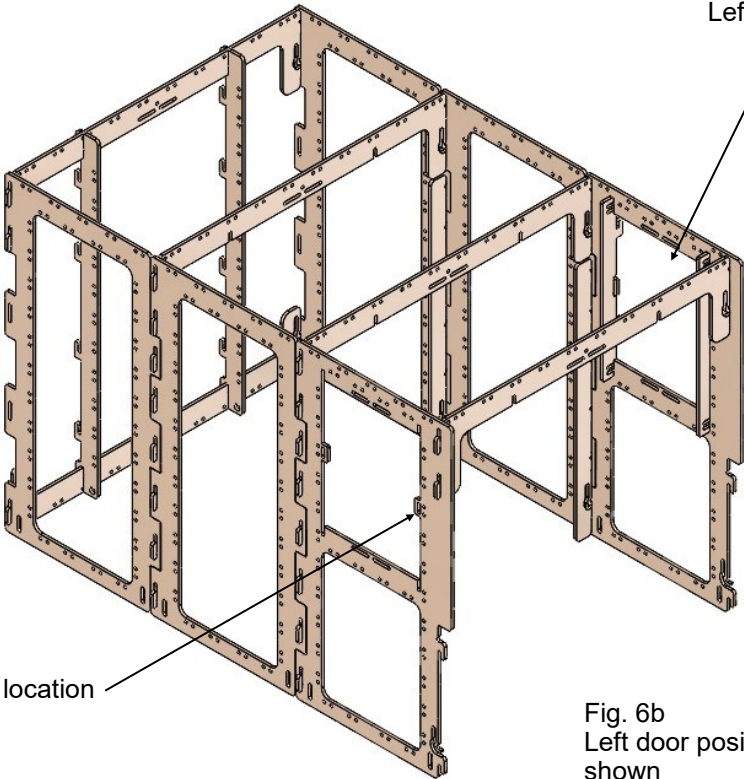

Fig. 6a
Left door position shown



Right Side Door location

Left Side Door location

Fig. 6b
Left door position shown

LARGE COOP RUN Assembly

Step 7: Place both the door and side door components in place by inserting the door frame and side door frame tabs into the slots on each door and allowing the door to drop into place. The doors can now be opened by simply lifting the door up and off the chicken coop run.

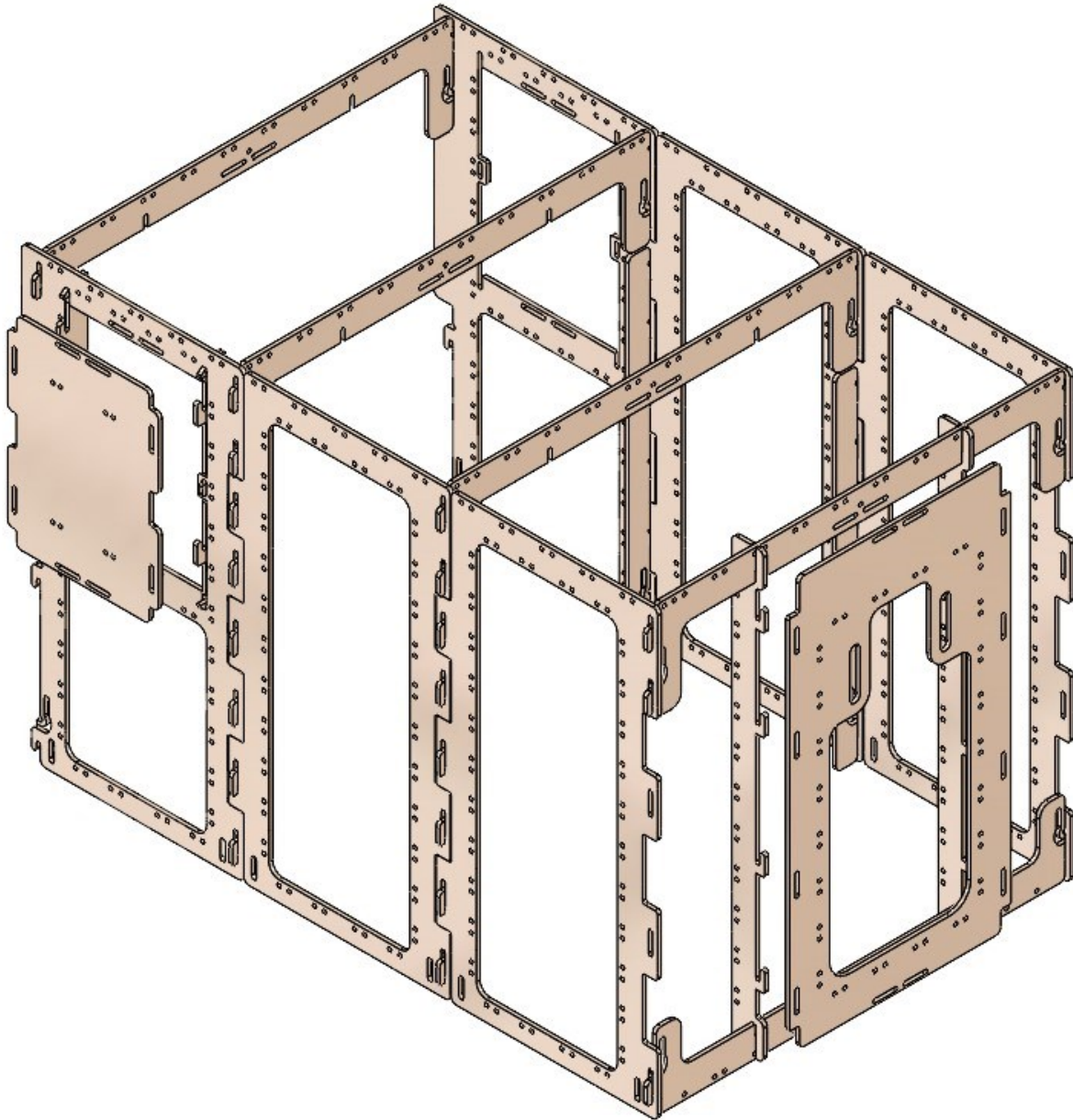

Fig. 7a

LARGE COOP RUN Assembly

Step 8: The Snaplock Large Chicken Coop Run is compatible with all standard chicken wire. Chicken wire is not included with the Snaplock Large Chicken Coop Run.

Cut the chicken wire to the following dimensions and quantities

- 33" x 19" quantity 2
- 42" x 17" quantity 5
- 34" x 18" quantity 1
- 21" x 17" quantity 1
- 45" x 21" quantity 3
- 44" x 16" quantity 2

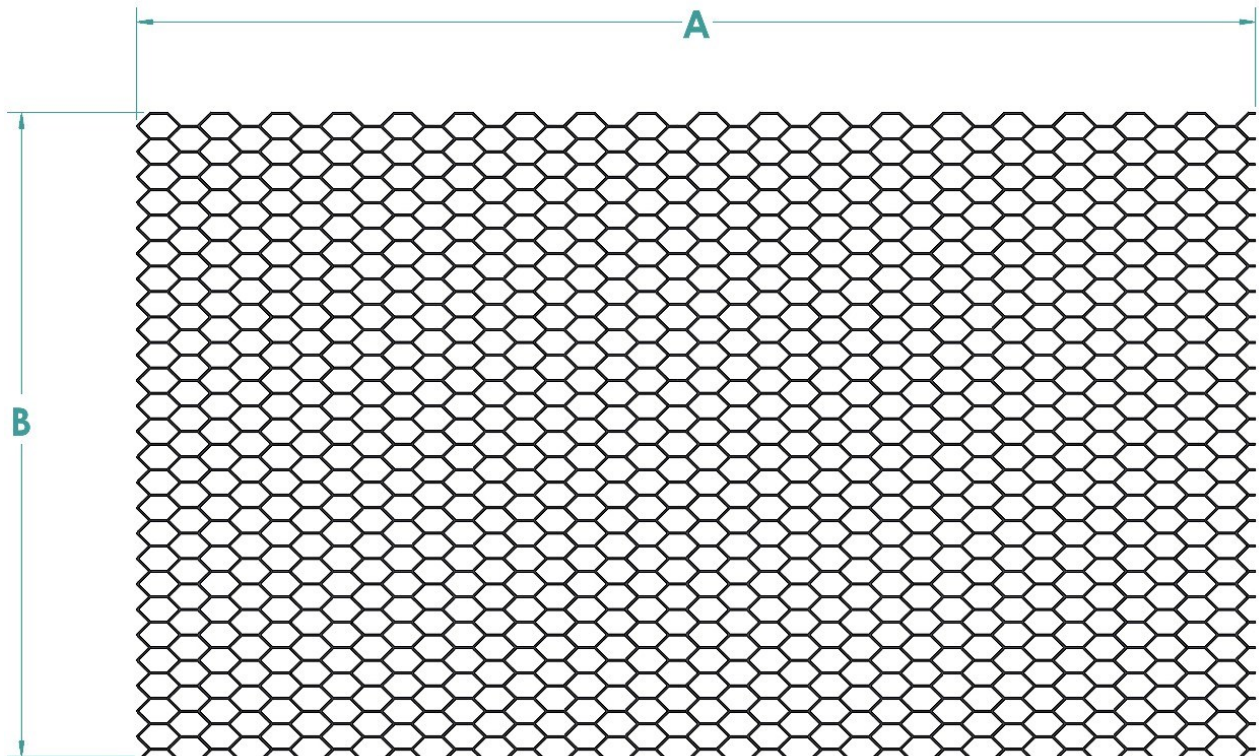

LARGE COOP RUN Assembly

Step 9: Use any zip tie or wire twist to attach the chicken wire segments to the large coop run and stand as shown

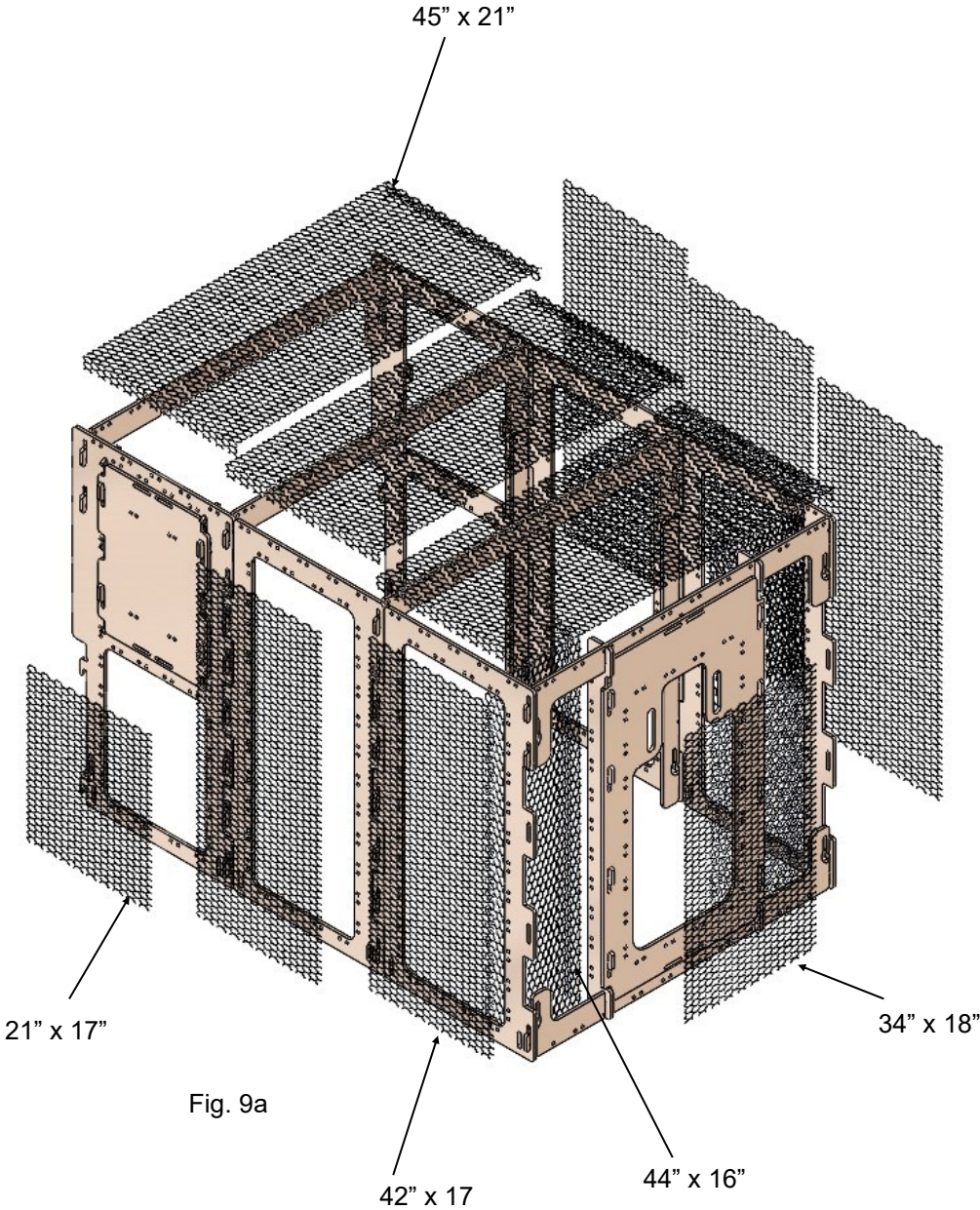

LARGE COOP RUN Assembly

Step 9 continued: Use any zip tie or wire twist to attach the chicken wire segments to the large coop run and stand as shown

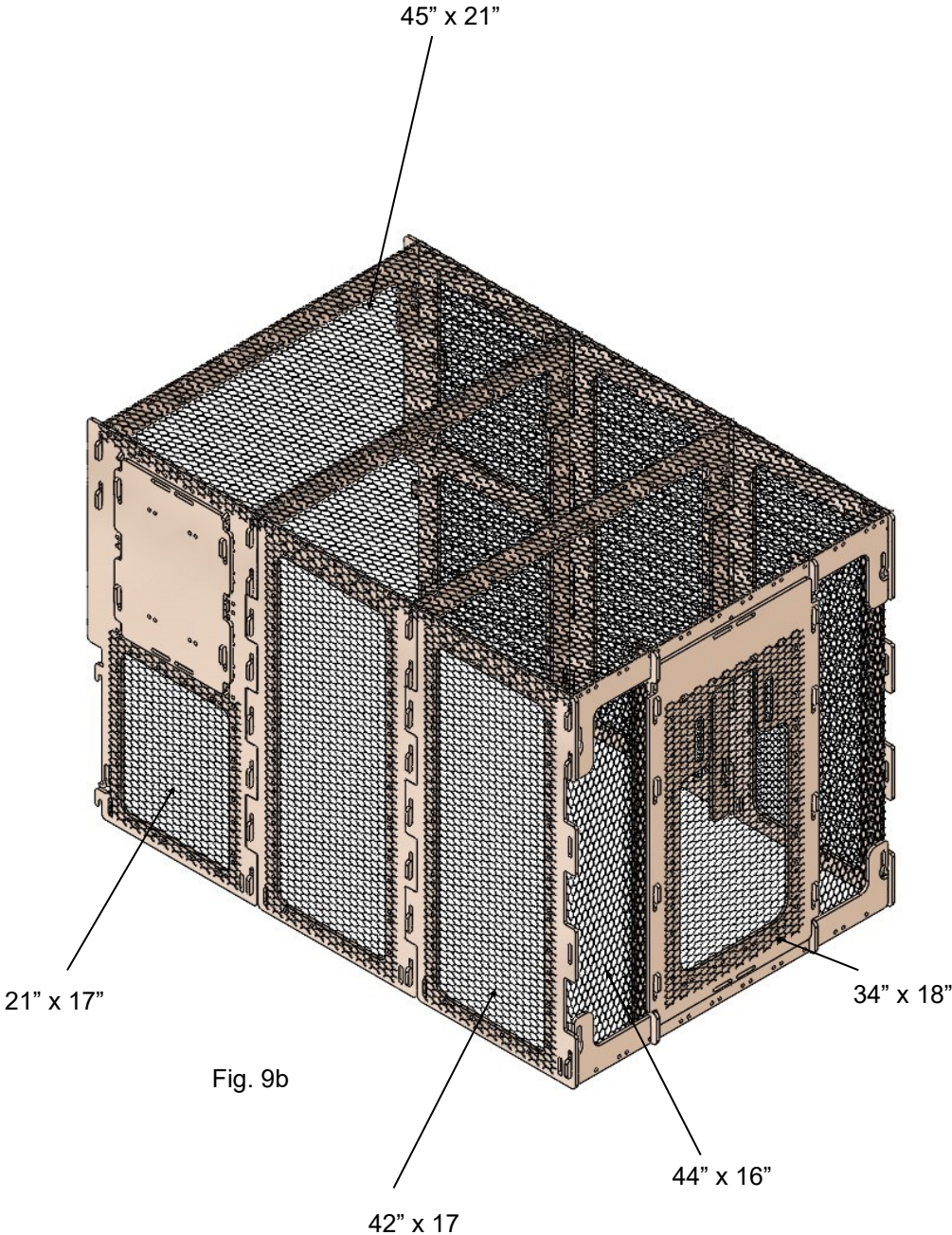

LARGE COOP RUN Assembly

Step 10: Attach the Large Chicken Coop Run to the Large Chicken Coop Stand by Inserting the tabs on the lower side of the run into the slots on the coop stand, then press down firmly until the coop run clicks into place

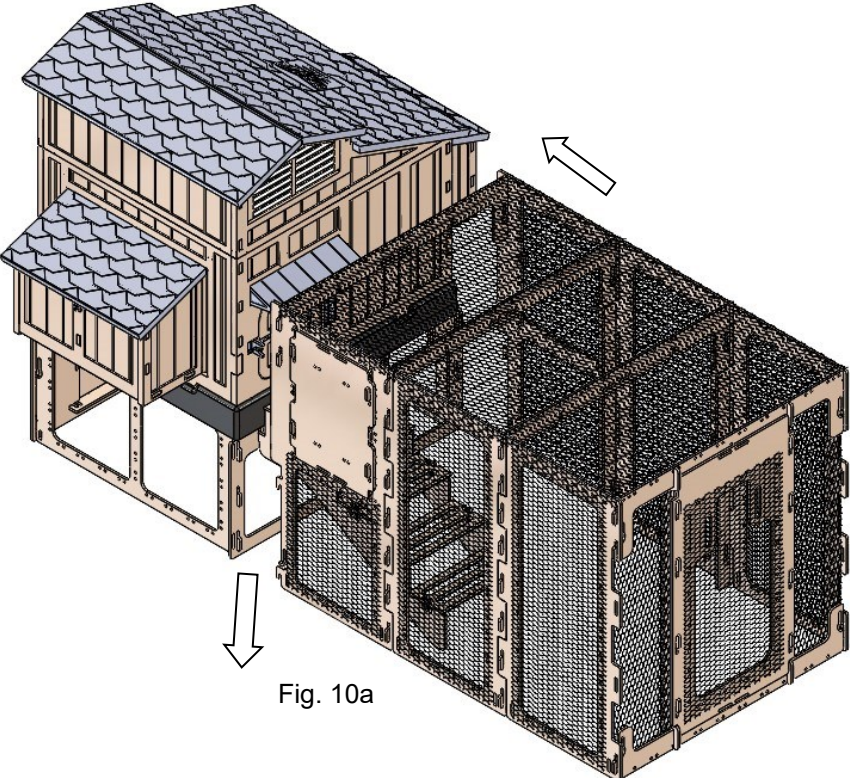

Fig. 10a

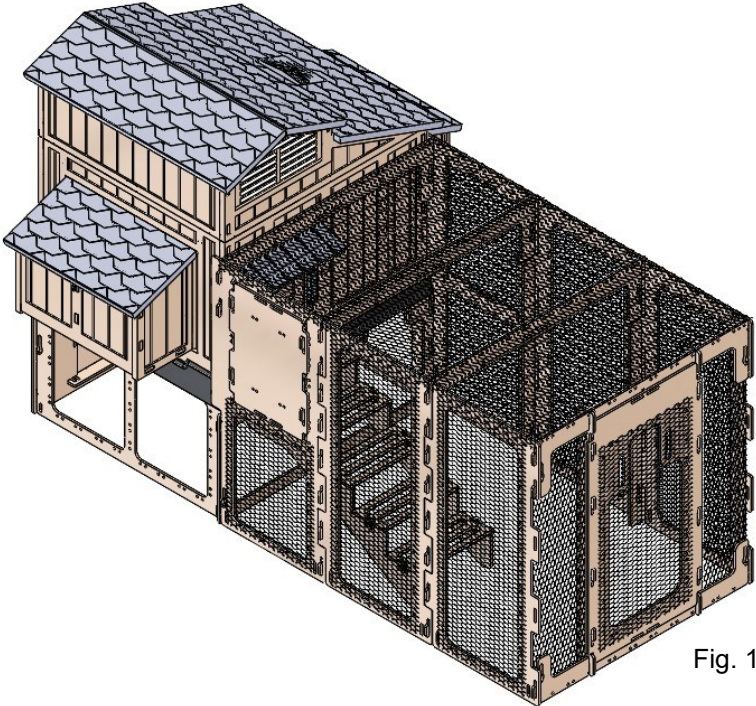

Fig. 10b

LARGE COOP RUN Assembly

Step 11: Attach the remaining 2 chicken wire pieces to the Large Coop Stand along the exposed sides using any zip tie or wire twist.

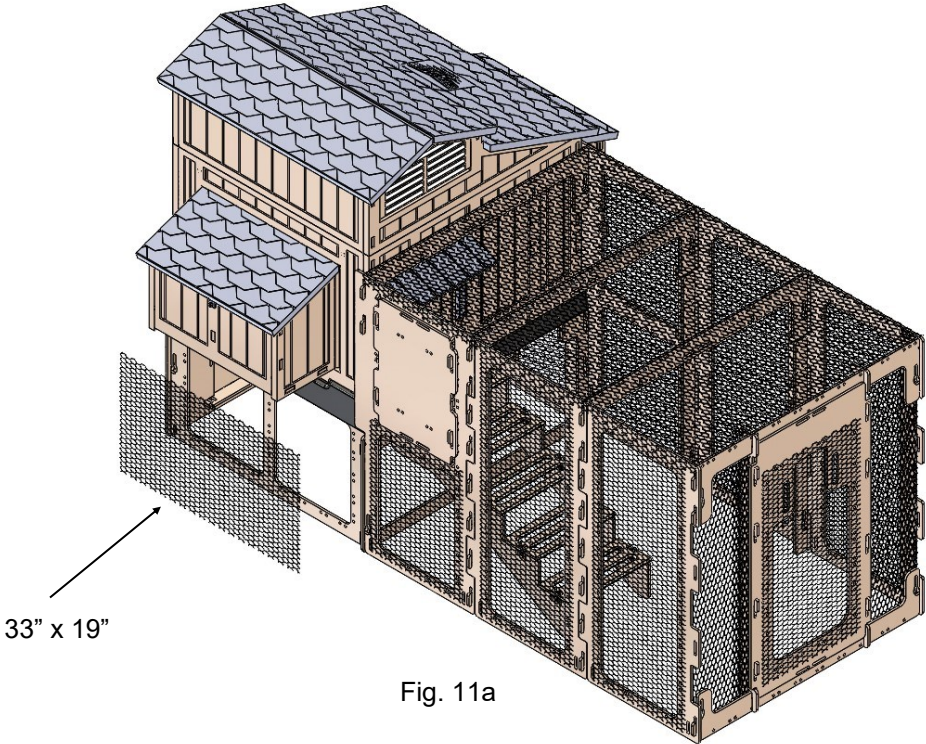

Fig. 11a

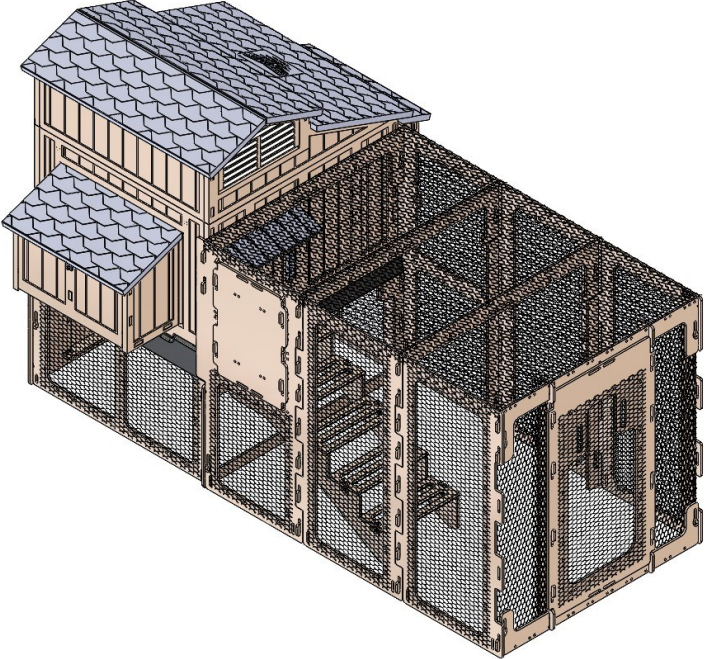

Fig. 11b