

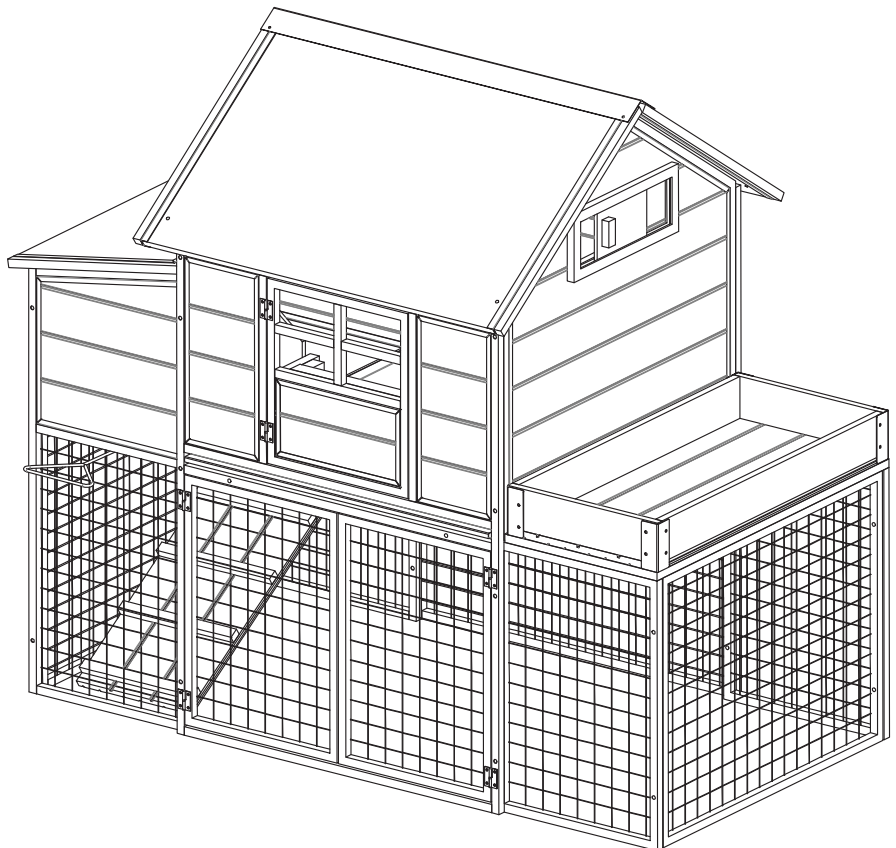

# BLOOMING CHICKEN COOP

Distributed by: Win World International Trade LLC., Ontario, CA  
www.PetGazebo.com & www.JJShelter.com  
Made in China



## ASSEMBLY MANUAL



TOOLS REQUIRED FOR ASSEMBLY  
(not included)

SKU NO.: 21950RW

# ■ PARTS LIST

01

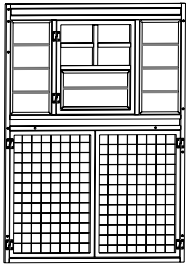

02

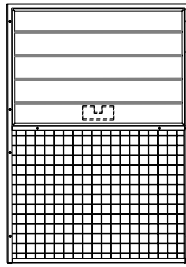

03

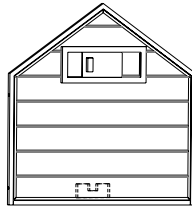

01 Coop Front Panel.....x1

02 Coop Back Panel.....x1

03 Coop Right Panel.....x1

04

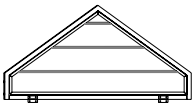

05

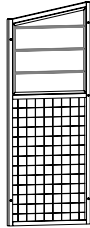

06

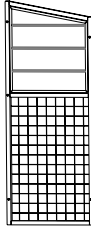

07

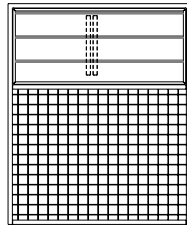

04 Coop Left Panel.....x1

05 Nesting Box Right Panel.....x1

06 Nesting Box Left Panel.....x1

07 Nesting Box Front Panel.....x1

08

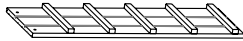

09

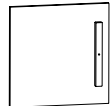

10



11



08 Ramp.....x1

09 Sliding Door.....x1

10 Nesting Box Support.....x1

11 Tray Holder.....x2

12

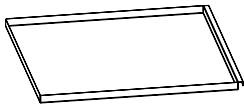

13

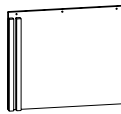

14



12 Tray.....x1

13 Nesting Box Floor.....x1

14 Nesting Box Guard.....x1

15

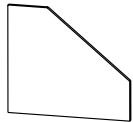

16

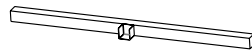

17



15 Nesting Box Divider.....x1

16 Long Roosting Bar.....x1

17 Short Roosting Bar.....x1

18

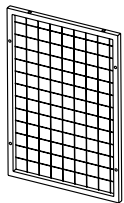

19

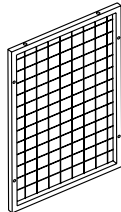

20

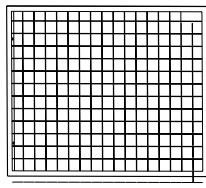

18 Left Mesh Panel.....x1

19 Right Mesh Panel.....x1

20 Front Mesh Panel.....x1

21

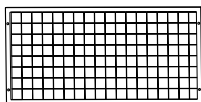

22



23



21 Top Mesh Panel.....x1

22 Raised Bed Long Side Board.....x2

23 Raised Bed Short Side Board.....x2

24

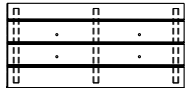

25



26



24 Raised Bed Floor.....x1

25 Coop Roof Panel.....x2

26 Nesting Box Roof Panel.....x1

27

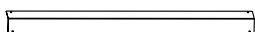

28



27 Coop Roof Ridge Cover.....x1

28 PVC Rain Guard.....x1

# ■ HARDWARE LIST



T-Handle.....x1

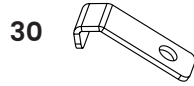

Ramp Hook.....x2

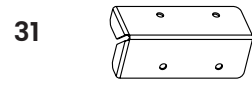

Raised Bed Corner Connector.....x4

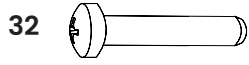

Bolt M6x45mm.....x10

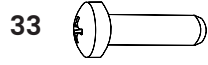

Bolt M6x30mm.....x26+1

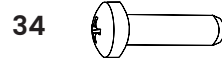

Bolt M6x30mm (black).....x4

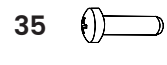

Bolt M4x20mm.....x1



Nut M6mm.....x10

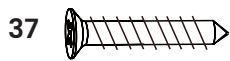

Self-tapping Screw  
4x30mm.....x3

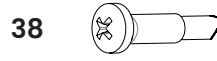

Self-tapping Screw  
4.2x13mm.....x8

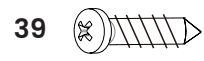

Self-tapping Screw  
3.5x13mm.....x20+1

# ■ ASSEMBLY INSTRUCTIONS

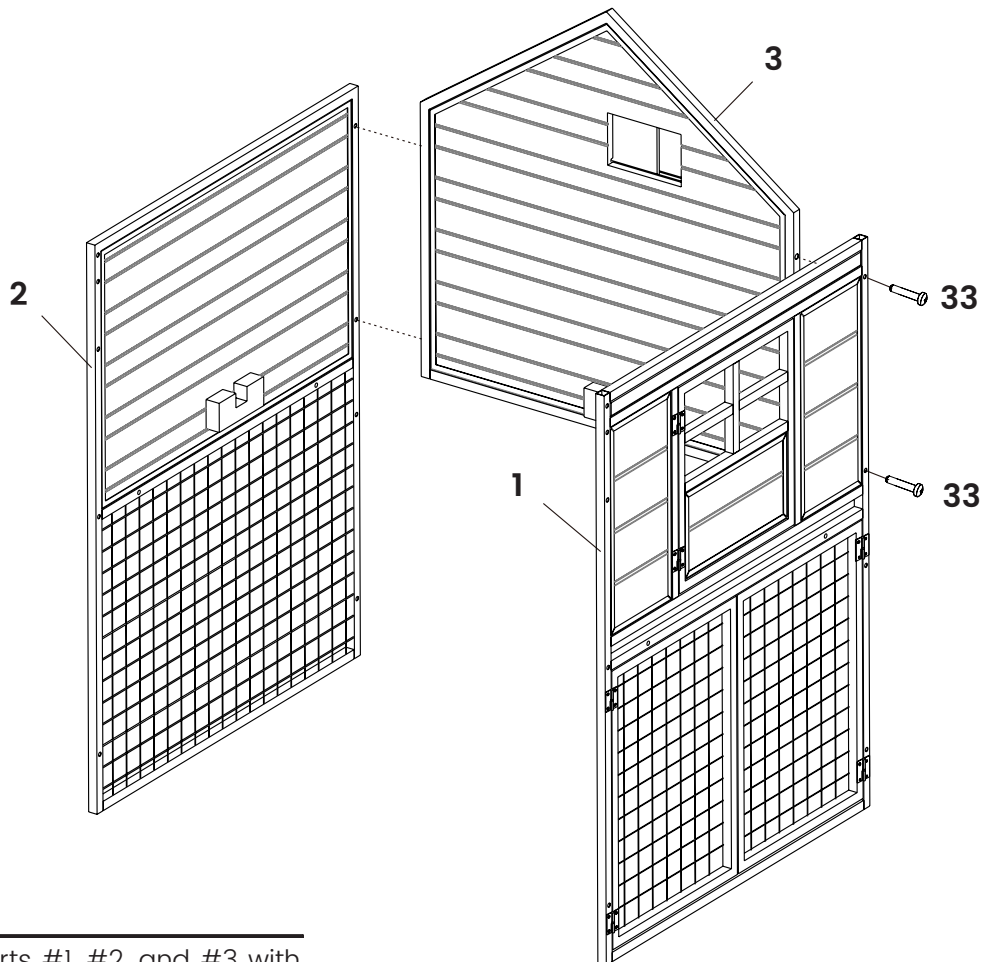

## Step 1 ▲

- Connect Parts #1, #2, and #3 with 4 pieces of Bolt #33.

## Step 2 ►

- Affix Parts 5 and 6 to the inside edge of Parts #1 & #2 using four pieces of the #32 Bolt (M6x45) and four pieces for the #36 Nut (M6), as shown in the diagram.
- Then, place Part #4 on top of Parts #5 and #6, then secure it between parts #1 and #2 with four of #33 screw.

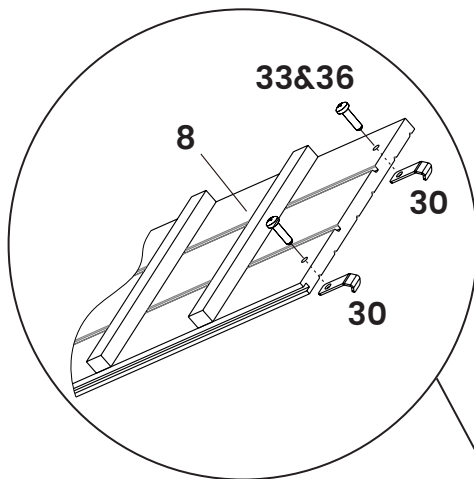
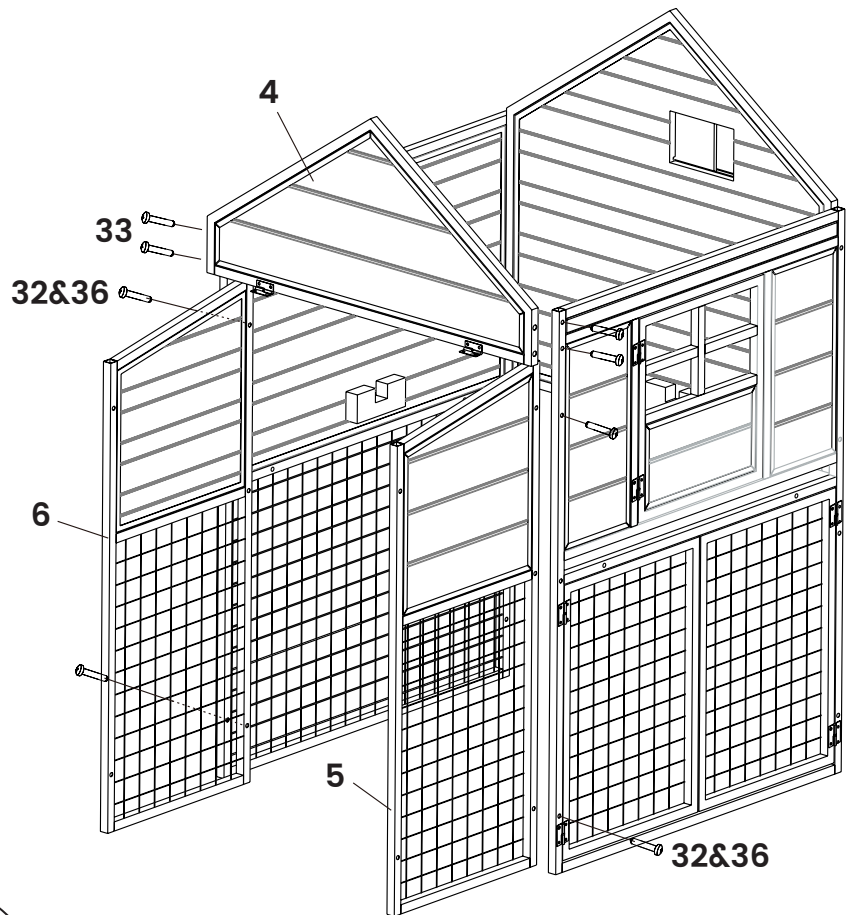

## Step 3 ►

- Using a #33 Bolt and #36 Nut, secure the two Ramp Hook parts (#30) to one end of the Ramp (#8).
- Then, as shown in the diagram below, hook the Ramp onto the mesh of (#6).
- Now, secure the two pieces of the Tray Holder (#11) using four pieces of Bolt #33.
- Next, secure the Nesting Box Support (#10) with two Bolts of #32.

Note: Make sure the U-channel opening of #10 is facing the outside, the Nesting Box side.

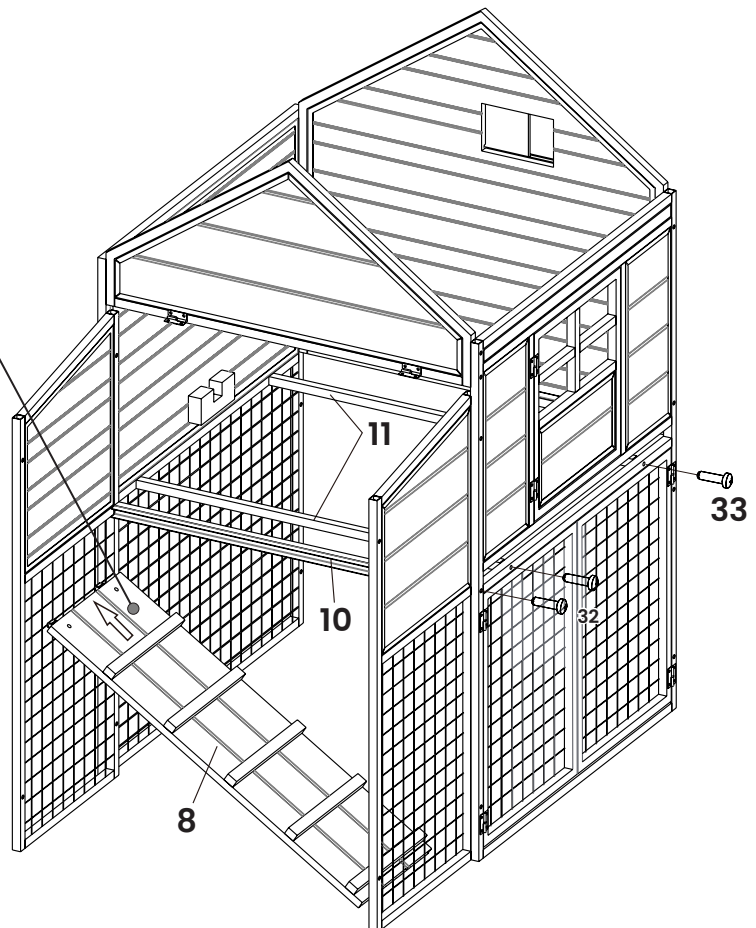

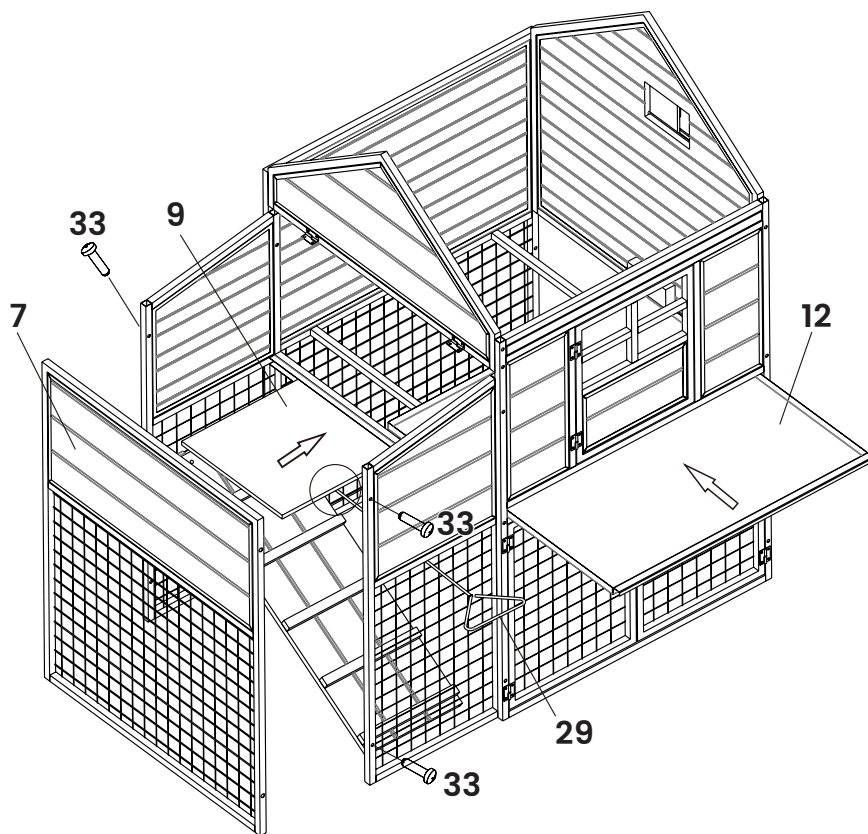

#### Step 4 ◀

- As shown in the diagram, insert the T-Handle (#29) through the mesh of the Panel (#5), insert the Sliding Door (#9) into the U-channel of #10, and secure the T-handle to the Sliding Door with the Bolt (#35).
- Using 4 pieces of Bolt #33, secure the Nesting Box Front Panel (#7) between #5 and #6, ensuring that the other side of the Sliding Door (#9) is inside the U-channel of #7.
- Place Tray (#12) into Coop.

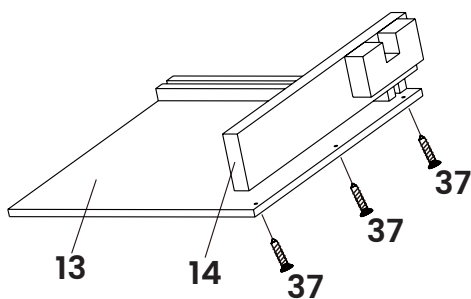

#### Step 5 ▶

- Using 3pcs Screws (#37) to secure the Nesting Box Guard (#13) onto the Nesting Box Floor (#14). Then, as shown, place it inside the coop.
- Insert the Nesting Box Divider (#15) into the Nesting Box Floor's groove.
- Then insert the two Roosting Bars (#16 & #17) as shown in the diagram.

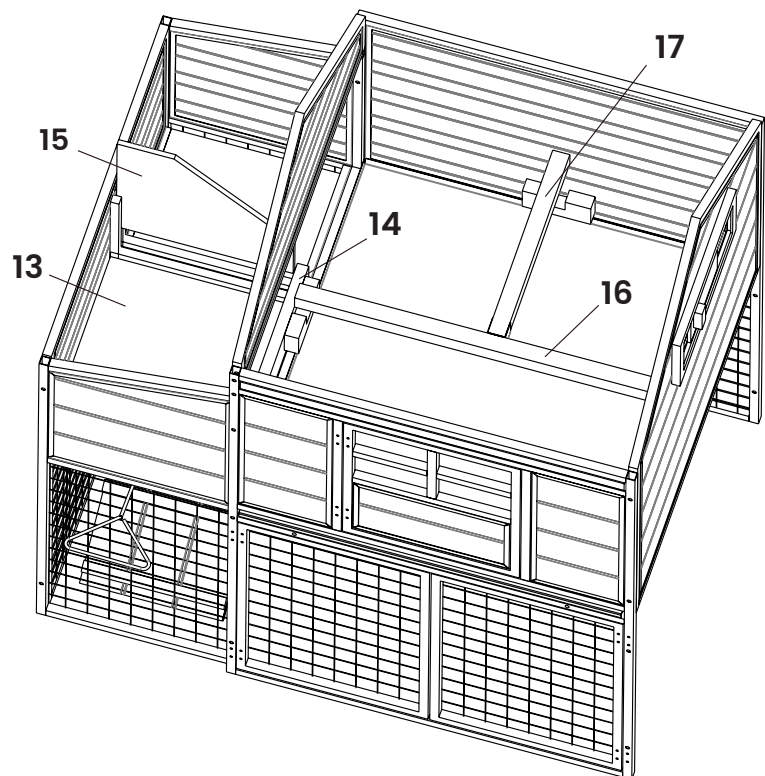

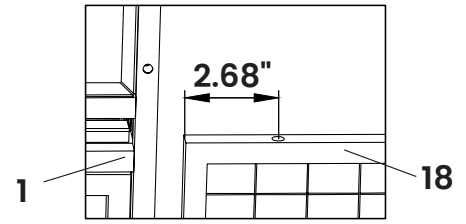
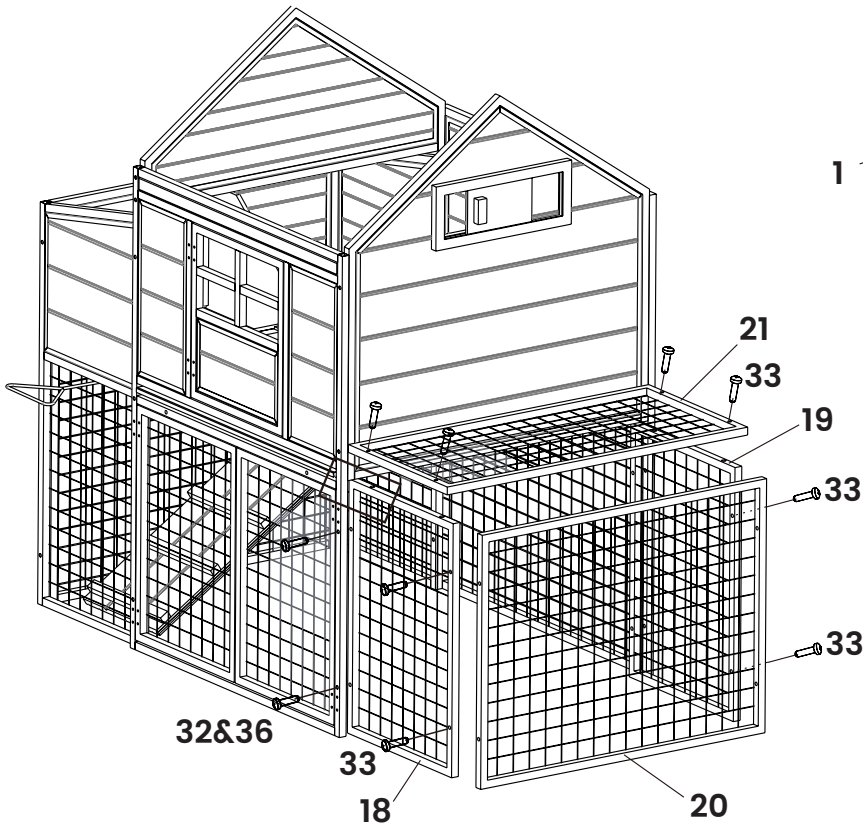

### Step 6 ◀

- Attach the Mesh Panels (#18, #19, #20, and #21). Begin by connecting the two side panels (#18 & #19) to the inside of Coop Panels (#1 & #2) with Bolts & Nuts (#32 & #36).
- Then, using 4pcs of Bolts (#33), secure the Front Mesh Panel (#20) between the two side mesh panels (#18 & #19).
- Next, place the Top Mesh Panels (#21) on top of (#18, #19, & #20), and connect them all together with Bolts (#33).

### Step 7 ▶

- Arrange the piece of Raised Bed Floor (#24), two pieces of Long Side Board (#22), and two pieces of Short Side Board (#23) according to the diagram, assemble them firmly with four pieces of the Corner Connector (#31) and sixteen of Screw #39.
- Then place the assembled unit directly above Mesh panel (#21).

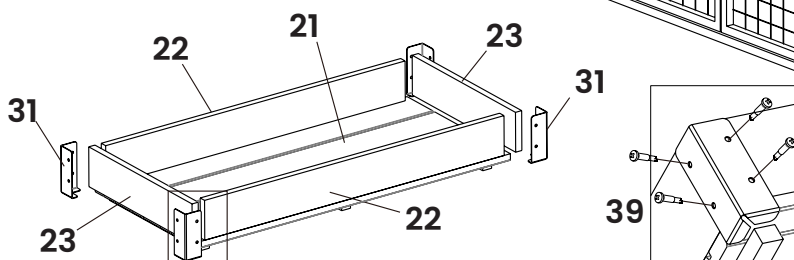
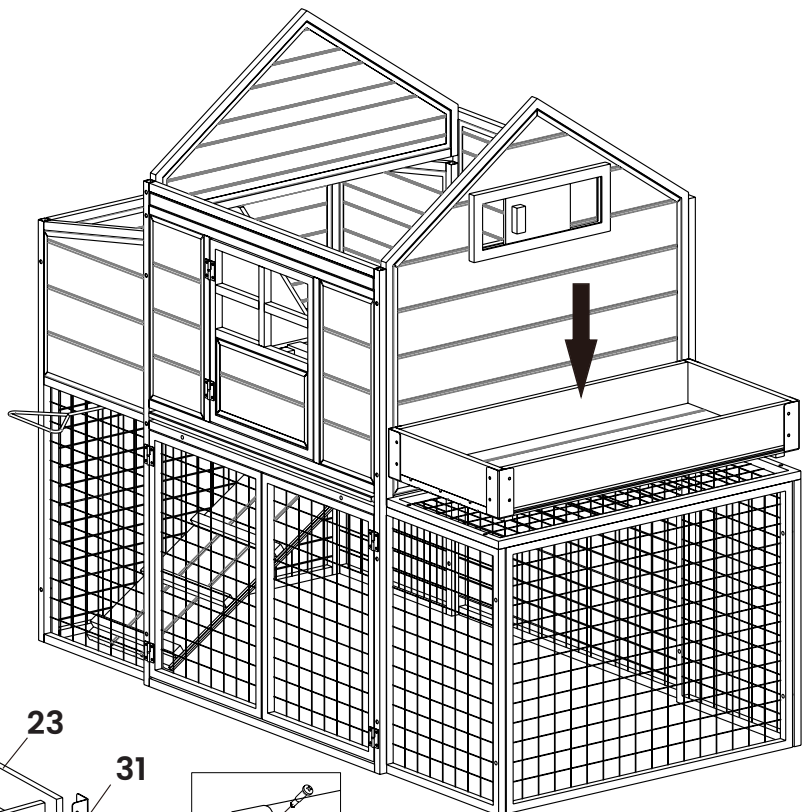

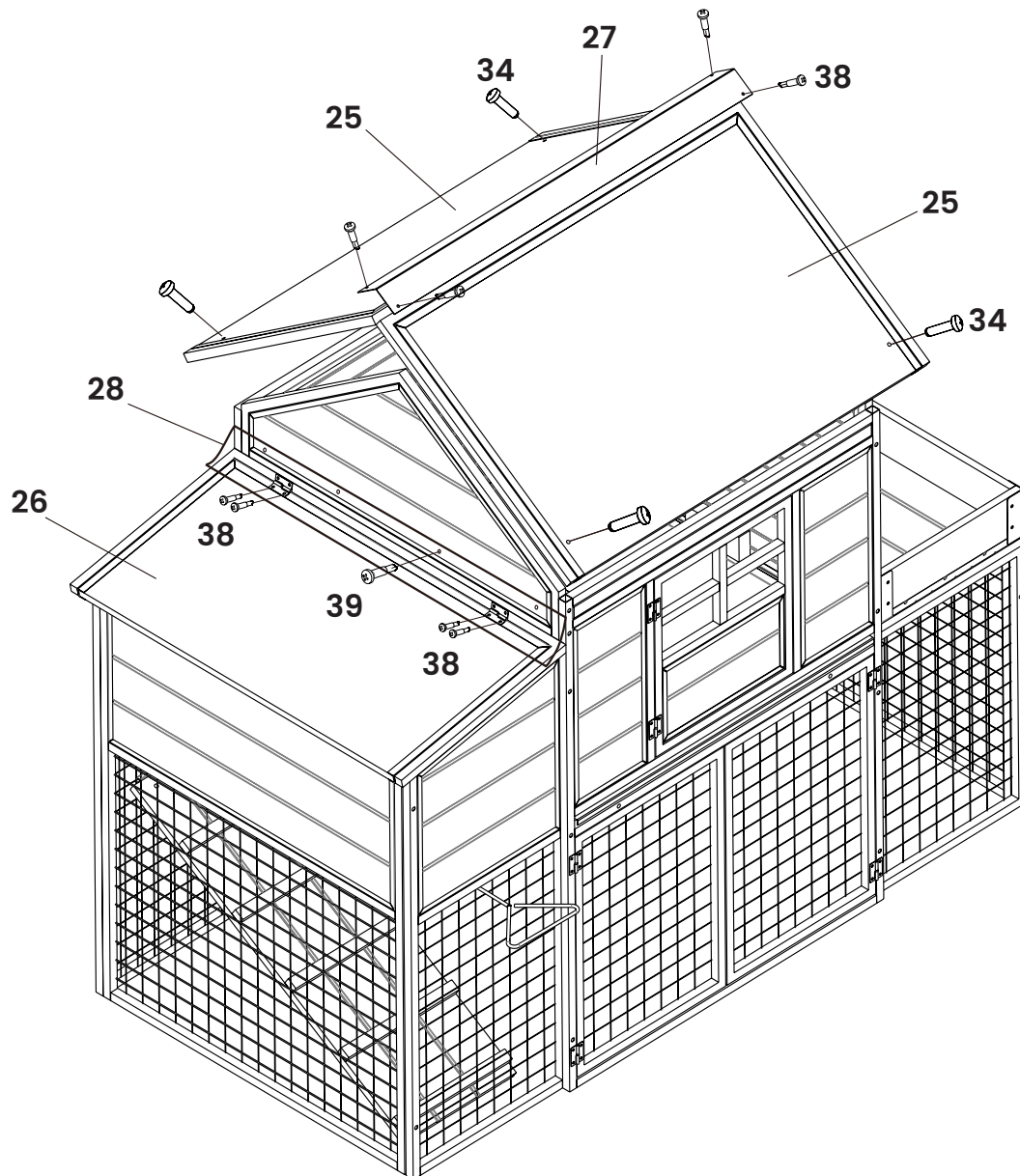

### Step 8 ▲

- Assemble two pieces of Roof Panel (#25) with four pieces of Bolt (#34), then install Roof Ridge Cover (#27) with four pieces of #38.
- Affix Nesting Box Roof Panel (#26) with four pieces of Screws (#38), and then install the PVC Rain Guard (#28) directly above the roof (#26) with four pieces of Screws (#39), as shown in the diagram.

**The coop now is fully assembled and ready to use.**

In the event of missing or defective parts please contact  
[customerservice@petgazebo.com](mailto:customerservice@petgazebo.com)