

ITEM # MWFHB53 Mango Wood Farm House Bench

Assembly Instructions - Max Weight Capacity 650 lbs

Components:

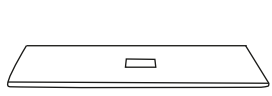

1 Piece Bench Top

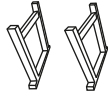

2 Pieces Table Legs



1 Piece Center Post

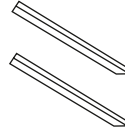

2 Short Posts



10 Bolts

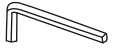

1 Hex Wrench

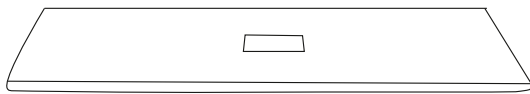

1) Place Bench Top on smooth surface.

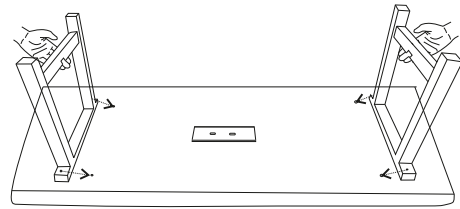

2) Position Bench Legs to Bench Top.

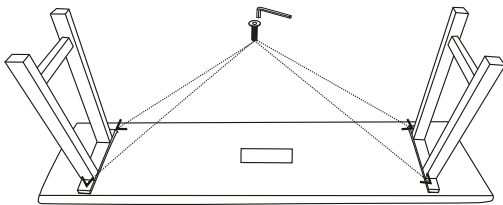

3) Attach Bench Legs using Bolts. Loosely tighten bolts.

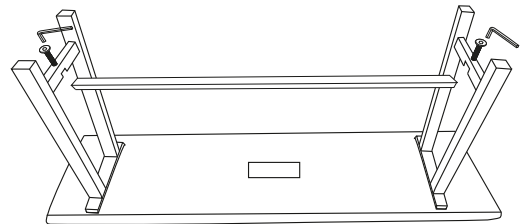

4) Attach Center Post using Bolts.

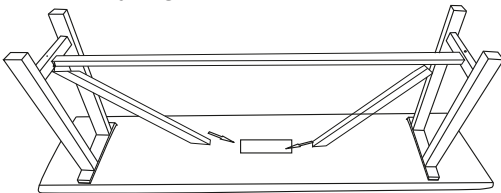

5) Attach Short Posts using Bolts.

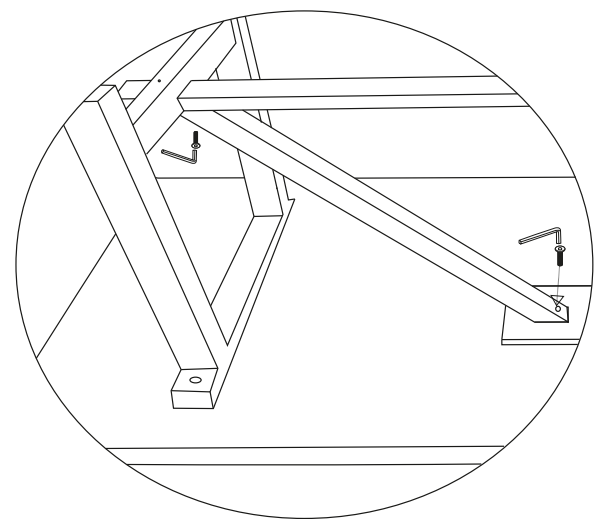
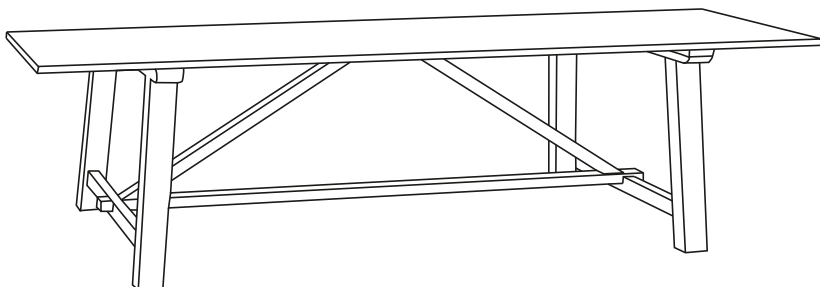

6) Tighten all bolts. Place bench upright.

If you experience a problem, have questions or need parts for this product, call Customer Service at **1-636-532-9888, Monday-Friday, 8 AM - 4 PM Central Time**