

- 1** Instale las ruedas (F) y (G) en la parte inferior de los 4 postes inferiores (C). Alternativamente, puede instalar el pie nivelador (E).

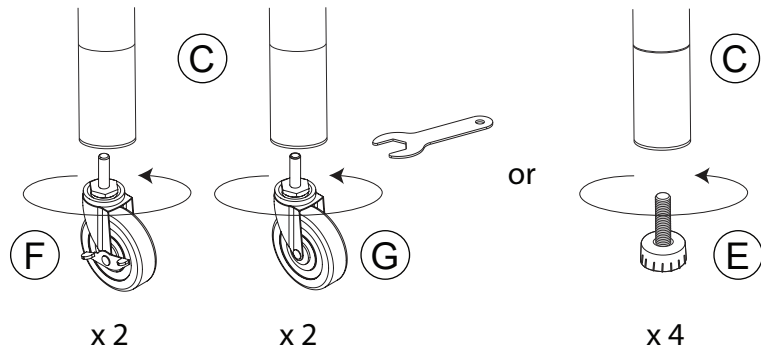

- 2** Snap el plástico Se engancha (D) en las ranuras de los postes inferiores (C) en la misma posición y asegúrese de que la flecha de los clips de plástico apunte hacia arriba.

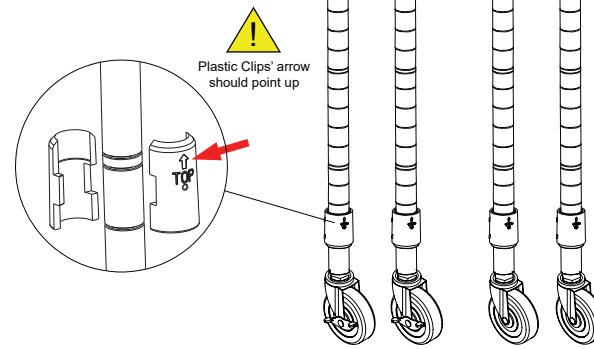

- 3** Asegúrese de tener la parrilla de alambre (A) en la posición correcta. (El espacio en el cuello debe quedar hacia abajo) Sostenga el estante de lado y deslice la parte superior de cuatro postes inferiores a través de la parte inferior de cada estante en sus esquinas hasta que haya un ajuste perfecto. Después de que 4 polos hayan sido se deslizó a través de los orificios del collar del estante, coloque el estante en posición vertical.

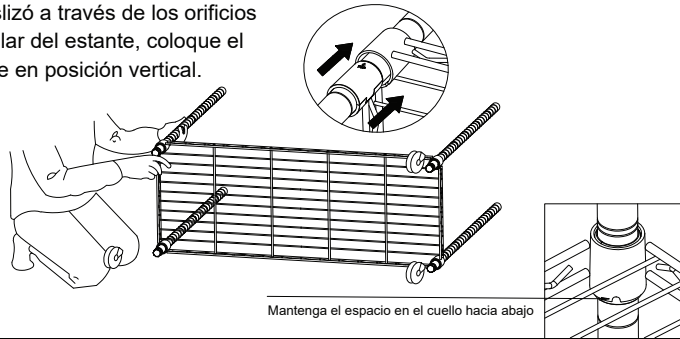

- 4** Consulte el Paso 2 para encajar los clips de plástico en las ranuras de cuatro piezas de baje los postes en la posición deseada y deslice hacia abajo la parrilla de alambre desde el la parte superior de cada poste inferior hacia abajo sobre los clips de plástico.

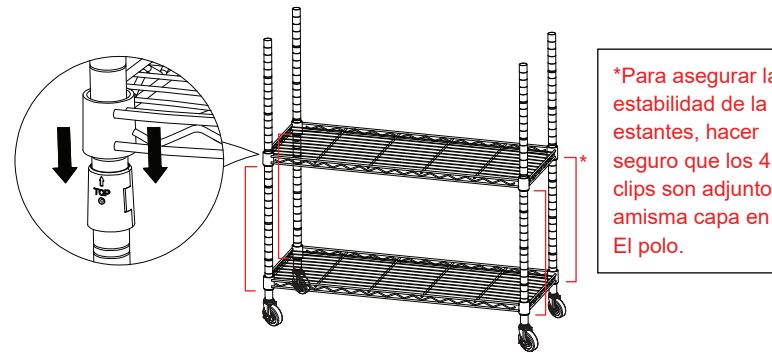

- 5** Atornille los postes superiores (B) en los postes inferiores utilizando los conectores de ambos extremos.

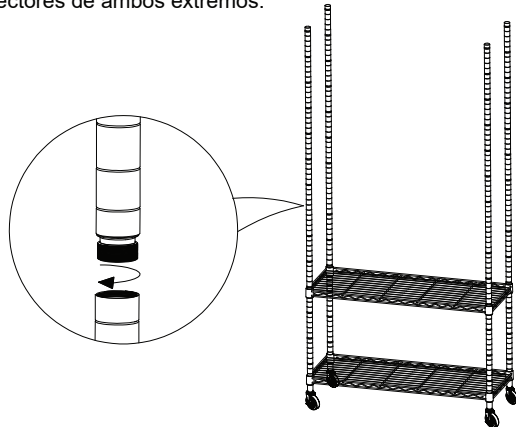

- 6** Consulte el Paso 4 para encajar los clips de plástico en las mismas ranuras de cada poste en la siguiente posición deseada para ensamblar los otros 3 estantes de alambre. Empuje firmemente hacia abajo en cada estante de alambre en sus esquinas con un mazo de goma para asegurarse de que todos los estantes estén colocados correctamente sobre los clips de plástico.

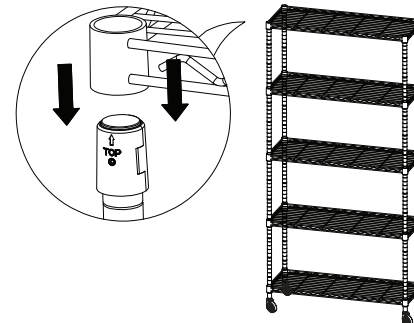

5-Shelf Shelving Storage Unit with Caster Wheels

Assembly Instructions

For additional support, email:
help@efineusa.com

or visit:
<https://efineusa.com/pages/contact-us>

Efine Shelving Units: 1 Year Limited Warranty

Efine USA ("Efine") warrants to the original purchaser ("Purchaser") of a EFINE NSF Shelf Unit ("Product") that each Product will be free from defects in workmanship and materials for a period 1 year from date of original purchase. Efine's obligations under this warranty are limited to repairing or replacing the product during the warranty period, or to provide reasonable compensation for the product, at Efine's option not to exceed the purchase price of the product. All replacement parts and products become the property of Efine and must be returned to Efine.

This warranty does not cover normal wear and tear of the product and its parts, as well as damage caused by negligent use or abuse of the product, use contrary to this user manual, or modification by anyone other than Efine. The one-year warranty period is not extended or renewed for product repair or replacement or compensation. Any warranties implied by applicable law are limited to one year from the date of purchase and are subject to the same conditions and limitations as our express warranties.

Except as provided in this Agreement and to the extent applicable, this product provides no warranties, express or implied, and Efine disclaims all warranties, including, but not limited to, implied warranties of merchantability, infringement, or fitness for a particular purpose. Any individual, company No warranty or guarantee given by any entity or entity with respect to this product shall be binding on Efine.

If your product is defective or needs repair or parts, please contact Efine Customer Service email at csr@efineusa.com. Please list out the model you purchased, date of purchase and product issues. Your service request must be accompanied by a copy of the original sales receipt.

Assembly Instructions

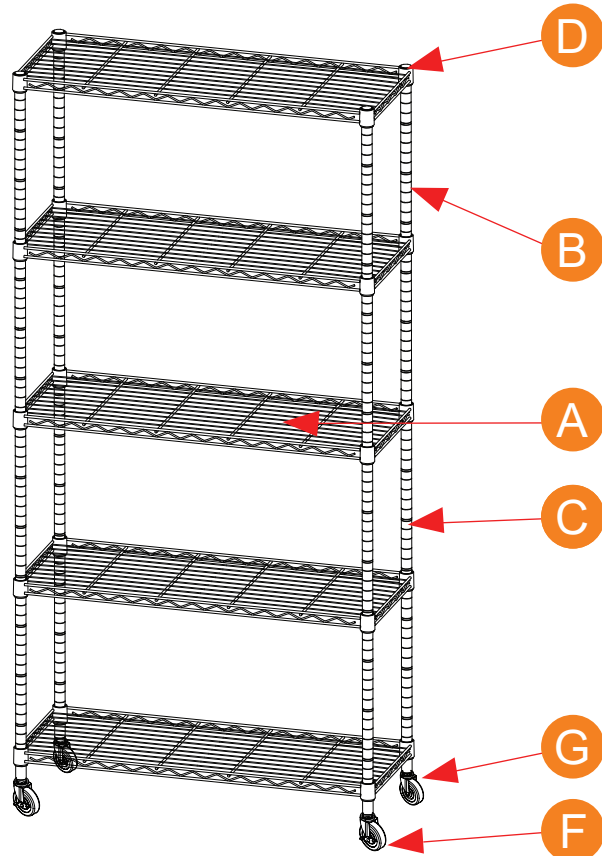

Parts List

	A	B	C	D	E
Name	Wire Shelf	Upper Pole	Lower Pole	Plastic Clip	Leveling Foot
Parts					
Qty	5PCS	4PCS	4PCS	40PCS	4PCS
	F	G			
Name	Wheel with Brakes	Wheel			
Parts					
Qty	2PCS	2PCS			

1 Install the Wheels (F) & (G) into the bottom of the 4 Lower Poles (C). Alternatively, you can install the Leveling Foot (E).

x 2 x 2 or x 4

2 Snap the Plastic Clips (D) into the pole grooves of lower poles(C) at the same position and make sure that the arrow of plastic clips are pointing up.

! Plastic Clips' arrow should point up

3 Please make sure that you have the wire shelf (A) the correct way up. (The gap in collar shall be faced down) Hold the shelf on its side and slide the top of four lower poles through the bottom of each shelf at its corners until there is a snug fit. After 4 poles have been slid through the shelf collar holes, set the shelf upright.

Keep the gap in collar face down

4 Refer to Step 2 to snap the plastic clips on the grooves of four pieces of lower poles at your desired position and slide down the wire shelf from the top of each lower pole down onto the plastic clips.

*To ensure the stability of the shelves, make sure all 4 clips are attached to the same layer on the pole.

5 Screw upper poles(B) into lower poles using the connectors from both ends.

6 Refer to the Step 4 to snap the plastic clips on the same grooves of each pole on your next desired position to assemble the other 3 wire shelves. Push firmly down on every wire shelf at its corners with a rubber mallet to ensure all the shelves are properly in place over the plastic clips.