

Panasonic®

Owner's Manual Microwave Oven Household Use Only Model No. NN-SD975S NN-SD775S

Safety Information

Precautions	Inside cover
Important Safety Instructions	1-3
Installation and Grounding instructions	4-5
Safety Precautions	6-7

Operation

Oven Components Diagram	9
Control Panel	10
Starting to Use Your Oven	11
Setting the Clock	11
Child Safety Lock	11
Dial Features	12
Function Features	12-13
Selecting Power & Cook Time	14
3-Stage Cooking	14
Keep Warm Feature	15
Quick 30 Feature	15
Coffee/Milk Feature	15
Popcorn Feature	16
More/Less Feature	16
Inverter Turbo Defrost Feature	17
Defrosting Tips & Techniques	17-18
Sensor Reheat Feature	19

Operation

Sensor Cook Feature	19
Sensor Cook Chart	20-21
Microwave Recipes	22
Timer Feature (Kitchen Timer/Stand Time/Delay Start)	23
Microwave Shortcuts	24-25
Food Characteristics	26
Cooking Techniques	26-27
Quick Guide to Operation	31-32

Maintenance

Care and Cleaning of Your Microwave Oven	28
Accessory Purchases	29
Before Requesting Service	29
Limited Warranty (Only for U.S.A.)	30

General Information

Cookware Guide	8
Specifications	33
User's Record	34

READ ALL INSTRUCTIONS CAREFULLY BEFORE USING THE OVEN.

Para instrucciones en español, voltee el libro.

For assistance, please call: 1-800-211-PANA(7262)
contact us via the web at:
<http://www.us.panasonic.com/contactinfo>

(U.S.A and Puerto Rico)

For microwave oven safety reference, please visit FDA's webpage at:

<http://www.fda.gov/Radiation-EmittingProducts/ResourcesforYouRadiationEmittingProducts/Consumers/ucm252762.htm>

F0003BP00AP

PA0215-0

Printed in China

© Panasonic Appliances Microwave Oven (Shanghai) Co., Ltd. 2015

Microwave Oven Safety

Your safety and the safety of others are very important.

We have provided important safety messages in this manual and on your appliance. Always read and obey all safety messages.



This is the safety alert symbol. It is used to alert you to potential hazards that can kill or hurt you and others.

All safety messages will follow the safety alert symbol and either the word "DANGER", "WARNING" or "CAUTION". These words mean:

DANGER

You can be killed or seriously injured if you don't immediately follow instructions.

WARNING

You can be killed or seriously injured if you don't follow instructions.

CAUTION

You can be exposed to a potentially hazardous situation which, if not avoided, may result in minor or moderate injury.

All safety messages will tell you what the potential hazard is, tell you how to reduce the chance of injury, and tell you what can happen if the instructions are not followed.



PRECAUTIONS TO AVOID POSSIBLE EXPOSURE TO EXCESSIVE MICROWAVE ENERGY

- (a) Do not attempt to operate this oven with the door open since open-door operation can result in harmful exposure to microwave energy. It is important not to defeat or tamper with the safety interlocks.
- (b) Do not place any object between the oven front face and the door or allow soil or cleaner residue to accumulate on sealing surfaces.
- (c) Do not operate the oven if it is damaged. It is particularly important that the oven door close properly and that there is no damage to the:
 - (1) door (bent),
 - (2) hinges and latches (broken or loosened),
 - (3) door seals and sealing surfaces.
- (d) The oven should not be adjusted or repaired by anyone except properly qualified service personnel.

Thank you for purchasing a Panasonic Microwave Oven.

Your microwave oven is a cooking appliance and you should use as much care as you use with a stove or any other cooking appliance. When using electric appliance, basic safety precautions should be followed, including the following:

IMPORTANT SAFETY INSTRUCTIONS

WARNING

To reduce the risk of burns, electric shock, fire, injury to persons, or exposure to excessive microwave energy:

1. Read all instructions before using this appliance.
2. Read and follow the specific "PRECAUTIONS TO AVOID POSSIBLE EXPOSURE TO EXCESSIVE MICROWAVE ENERGY," found on the inside front cover.
3. This appliance must be grounded. Connect only to a properly grounded outlet. See "GROUNDING INSTRUCTIONS" found on page 4.
4. As with any cooking appliance, **DO NOT** leave oven unattended while in use.
5. Install or locate this appliance only in accordance with the installation instructions found on page 4, 5.
6. **DO NOT** cover or block any openings on this appliance.
7. **DO NOT** store this appliance outdoors. **DO NOT** use this product near water — for example, near a kitchen sink, in a wet basement, or near a swimming pool or similar locations.
8. Use this appliance only for its intended use as described in this manual. **DO NOT** use corrosive chemicals, vapors or non-food products in this appliance. This type of oven is specifically designed to heat, or cook food. It is not designed for industrial or laboratory use. The use of corrosive chemicals in heating or cleaning will damage the appliance and may result in radiation leaks.
9. When cleaning surfaces of the door and oven that come together on closing the door, use only mild, non-abrasive soaps or detergents applied with a sponge or soft cloth.
10. **DO NOT** allow children to use this appliance, unless closely supervised by an adult. **DO NOT** assume that because a child has mastered one cooking skill he/she can cook everything.
11. **DO NOT** operate this appliance if it has a damaged cord or plug, if it is not working properly, or if it has been damaged or dropped.
12. **DO NOT** immerse cord or plug in water.
13. Keep cord away from heated surfaces.
14. **DO NOT** let cord hang over edge of a table or counter.
15. This appliance should be serviced only by qualified service personnel. Contact the nearest authorized service center for examination, repair or adjustment.



IMPORTANT SAFETY INSTRUCTIONS

(continued)

16. Some products such as whole eggs with or without shell, narrow neck bottles and sealed containers — for example, closed glass jars — may explode and should not be heated in this oven.
17. To reduce the risk of fire in the oven cavity:
 - (a) **DO NOT** overcook food. Carefully attend appliance when paper, plastic, or other combustible materials are placed inside the oven to facilitate cooking.
 - (b) Remove wire twist-ties from paper or plastic bags before placing bag in oven.
 - (c) **If material inside the oven ignites, keep oven door closed, turn oven off, and disconnect the power cord, or shut off power at the fuse or circuit breaker panel.**
 - (d) **DO NOT** use the cavity for storage purposes. **DO NOT leave paper products, cooking utensils or food in the cavity when not in use.**

18. Superheated Liquids

Liquids, such as water, coffee, or tea are able to be overheated beyond the boiling point without showing evidence (or signs) of boiling. Visible bubbling is not always present when the container is removed from the microwave oven. THIS COULD RESULT IN VERY HOT LIQUIDS SUDDENLY BOILING OVER WHEN THE CONTAINER IS DISTURBED OR A UTENSIL IS INSERTED INTO THE LIQUID.

To reduce the risk of injury to persons:

- (a) **STIR THE LIQUID BOTH BEFORE AND HALFWAY THROUGH HEATING IT.**
 - (b) **DO not heat water and oil, or fats together. The film of oil will trap steam, and may cause a violent eruption.**
 - (c) **DO NOT** use straight-sided containers with narrow necks.
 - (d) After heating, allow the container to stand in the microwave oven for a short time before removing the container.
19. **DO NOT** cook directly on the turntable. It can crack, cause injury or damage to the oven.
 20. For the oven designed for installation into a wall cabinet:
 - (a) **DO NOT** operate any heating or cooking appliance beneath this appliance.
 - (b) **DO NOT** mount unit over or near any portion of a heating or cooking appliance.
 - (c) **DO NOT** mount over a sink.
 - (d) **DO NOT** store anything directly on the top of the appliance surface when the appliance is in operation.



IMPORTANT SAFETY INSTRUCTIONS

(continued)

WARNING

TO AVOID THE RISK OF SHOCK:

DO NOT remove outer panel from oven. Repairs must be done only by a qualified service person.

TO REDUCE THE RISK OF EXPOSURE TO MICROWAVE ENERGY:

DO NOT tamper with, or make any adjustments or repairs to Door, Control Panel Frame, Safety Interlock Switches, or any other part of oven, microwave leakage may result.

TO AVOID THE RISK OF FIRE:

1. **DO NOT** operate the microwave oven empty or use metal containers. When using the microwave oven without water or food, microwave energy cannot be absorbed and will continuously reflect throughout the cavity. This will cause arcing and damage the oven cavity, door or other components, which can lead to a fire hazard.
2. **DO NOT** store flammable materials next to, on top of, or in the oven.
3. **DO NOT** dry clothes, newspapers or other materials in the oven, or use newspaper or paper bags for cooking.
4. **DO NOT** hit or strike Control Panel. Damage to controls may occur.
5. **DO NOT** use recycled paper products unless the paper product is labeled as safe for microwave oven use. Recycled paper products may contain impurities which may cause sparking.

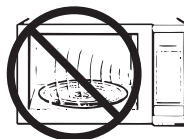

TO AVOID THE RISK OF SCALDING:

POT HOLDERS should always be used when removing items from the oven. Heat is transferred from the **HOT** food to the cooking container and from the container to the Glass Tray. The Glass Tray can also be very **HOT** after removing the cooking container from the oven.

SAVE THESE INSTRUCTIONS

For proper use of your oven, read remaining safety cautions and operating instructions.

Glass Tray

1. **DO NOT** operate the oven without the Roller Ring and the Glass Tray in place.
2. **DO NOT** operate the oven without the Glass Tray fully engaged on the drive hub. Improper cooking or damage to the oven could result. Verify that the Glass Tray is properly engaged and rotating by observing its rotation when you press Start.
NOTE: The Glass Tray can turn in either direction.
3. Use only the Glass Tray specifically designed for this oven. **DO NOT** substitute any other glass tray.
4. If the Glass Tray is hot, allow to cool before cleaning or placing in water.
5. **DO NOT** cook directly on the Glass Tray. Always place food in a microwave safe dish.
6. If food or utensils on the Glass Tray touch oven walls, causing the tray to stop moving, the tray will automatically rotate in the opposite direction.

Roller Ring

1. The Roller Ring and oven floor should be cleaned frequently to prevent excessive noise.
2. Always replace the Roller Ring and the Glass Tray in their proper positions.
3. The Roller Ring must always be used for cooking along with the Glass Tray.



INSTALLATION AND GROUNDING INSTRUCTIONS

Examine Your Oven

Unpack oven, remove all packing material and examine the oven for any damage such as dents, broken door latches or cracks in the door. Notify dealer immediately if oven is damaged. **DO NOT** install if oven is damaged.

Placement of Oven

1. The oven must be placed on a flat, stable surface. Place the front surface of the door 3 inches (7.6 cm) or more from the counter top edge to avoid accidental tipping of the microwave oven during normal use. For proper operation, the oven must have sufficient air flow. Allow 3 inches (7.6 cm) of space on both sides of the oven and 2 inches (5 cm) of space on top of the oven.
 - (a) **DO NOT** block air vents. If they are blocked during operation, the oven may overheat and be damaged.
 - (b) **DO NOT** place oven near a hot, damp surface such as a gas or electric range, or dishwasher.
 - (c) **DO NOT** operate oven when room humidity is excessive.
2. This oven is manufactured for household use only. It is not approved or tested for mobile vehicle, marine, or commercial use.

Installation

1. **DO NOT** block air vents. If they are blocked during operation, the oven may overheat. If the oven overheats, a thermal safety device will turn the oven off. The oven will remain inoperable until it has cooled.
2. If the oven is designed for installation into a wall cabinet by using the proper trim kit available from a local Panasonic dealer, follow all instructions packed with the kit.



WARNING

IMPROPER USE OF THE GROUNDING PLUG CAN RESULT IN A RISK OF ELECTRIC SHOCK.

Consult a qualified electrician or service person if the grounding instructions are not completely understood, or if doubt exists as to whether the appliance is properly grounded. If it is necessary to use an extension cord, use only a three wire extension cord that has a three prong polarized grounding plug, and a three slot receptacle that will accept the plug on the appliance. The marked rating of the extension cord should be equal to or greater than the electrical rating of the appliance.

Grounding Instructions

THIS APPLIANCE MUST BE GROUNDED. In the event of an electrical short circuit, grounding reduces the risk of electric shock by providing an escape wire for the electric current. This appliance is equipped with a cord having a grounding wire with a grounding plug. The plug must be plugged into an outlet that is properly installed and grounded.

- **Plug into properly installed and grounded 3 prong outlet.**
- **DO NOT** remove ground prong.
- **DO NOT** use an adapter.



INSTALLATION AND GROUNDING INSTRUCTIONS

(continued)

Power supply

1. A short power-supply cord is provided to reduce the risks resulting from becoming entangled in or tripping over a longer cord.
2. Longer cord sets or extension cords are available and may be used if care is exercised in their use. **DO NOT** let cord hang over edge of a table or counter.
3. If a long cord or extension cord is used, (1) the marked electrical rating of the cord set or extension cord should be at least as great as the electrical rating of the appliance, (2) the extension cord must be a grounding-type 3-wire cord, and (3) the longer cord should be arranged so that it will not drape over the counter top or tabletop where it can be pulled on by children or tripped over accidentally.



Wiring requirements

The oven must be operated on a SEPARATE CIRCUIT. No other appliance should share the circuit with the microwave oven. If it does, the branch circuit fuse may blow or the circuit breaker may trip. The oven must be plugged into at least a 20 AMP, 120 VOLT, 60 Hz GROUNDED OUTLET. Where a standard two-prong outlet is encountered, it is the personal responsibility and obligation of the consumer to have it replaced with a properly grounded three-prong outlet. The VOLTAGE used must be the same as specified on this microwave oven (120 V, 60 Hz). Using a higher voltage is dangerous and may result in a fire or oven damage. Using a lower voltage will cause slow cooking. Panasonic is NOT responsible for any damages resulting from the use of the oven with any voltage other than specified.

TV / RADIO / WIRELESS EQUIPMENT INTERFERENCE

1. Operation of the microwave oven may cause interference to your radio, TV, Wi-Fi, cordless telephone, baby monitor, blue tooth, or other wireless equipment.
2. When there is interference, it may be reduced or eliminated by taking the following measures:
 - (a) Place the radio, TV, etc. away from the microwave oven as far as possible.
 - (b) Use a properly installed antenna to obtain stronger signal reception.
 - (c) Clean door and sealing surfaces of the oven. (See Care and Cleaning of Your Microwave Oven)



Safety Precautions

Follow These Safety Precautions When Cooking in Your Oven.

IMPORTANT

Proper cooking depends upon the power, the time setting and quantity of food. if you use a smaller portion than recommended but cook at the time for the recommended portion, fire could result.

1) HOME CANNING / STERILIZING / DRYING FOODS / SMALL QUANTITIES OF FOODS

- **DO NOT** use your oven for home canning. Your oven cannot maintain the food at the proper canning temperature. The food may be contaminated and then spoil.
- **DO NOT** use the microwave oven to sterilize objects (baby bottles, etc.). It is difficult to keep the oven at the high temperature needed for sterilization.
- **DO NOT** dry meats, herbs, fruits or vegetables in your oven. Small quantities of food or foods with low moisture content can dry out, scorch or catch on fire if overheated.

2) POPCORN

Popcorn may be popped in a microwave oven corn popper. Microwave popcorn which pops in its own package is also available. Follow popcorn manufacturers' directions and use a brand suitable for the cooking power of your microwave oven.

CAUTION: When using pre-packaged microwave popcorn, you can follow recommended package instructions or use the popcorn pad (refer to page 16). Otherwise, the popcorn may not pop adequately or may ignite and cause a fire. Never leave oven unattended when popping popcorn. Allow the popcorn bag to cool before opening, always open the bag facing away from your face and body to prevent steam burns.

3) DEEP FAT FRYING

- **DO NOT** deep fat fry in your microwave oven. Cooking oils may burst into flames and may cause damage to the oven and perhaps result in burns. Microwave utensils may not withstand the temperature of the hot oil, and can shatter or melt.

4) FOODS WITH NONPOROUS SKINS

- **DO NOT COOK/REHEAT WHOLE EGGS, WITH OR WITHOUT THE SHELL.** Steam buildup in whole eggs may cause them to explode, and possibly damage the oven or cause injury. Reheating SLICED hard-boiled eggs and cooking SCRAMBLED eggs is safe.
- **Potatoes, apples, whole squash and sausages** are examples of foods with nonporous skins. These types of foods must be pierced before microwave cooking to prevent them from exploding.

CAUTION: Cooking dry or old potatoes can cause fire.



Safety Precautions

(continued)

5) GLASS TRAY / COOKING CONTAINERS / FOIL

- Cooking containers get hot during microwaving. Heat is transferred from the HOT food to the container and the Glass Tray. Use pot holders when removing containers from the oven or when removing lids or plastic wrap covers from cooking containers, to avoid burns.
- The Glass Tray will get hot during cooking. It should be allowed to cool before handling or before paper products, such as paper plates or microwave popcorn bags, are placed in the oven for microwave cooking.
- When using foil in the oven, allow at least 1-inch (2.5 cm) of space between foil and interior oven walls or door.
- Dishes with metallic trim should not be used, as arcing may occur.

6) PAPER TOWELS / CLOTHS

- **DO NOT** use paper towels or cloths which contain a synthetic fiber woven into them. The synthetic fiber may cause the towel to ignite. Use paper toweling under supervision.

7) BROWNING DISHES / OVEN COOKING BAGS

- Browning dishes or grills are designed for microwave cooking only. Always follow instructions provided by the manufacturer. **DO NOT** preheat browning dish more than 6 minutes.
- If an oven cooking bag is used for microwave cooking, prepare according to package directions. **DO NOT** use a wire twist-tie to close bag, instead use plastic ties, cotton string or a strip cut from the open end of the bag.

8) THERMOMETERS

- **DO NOT** use a conventional meat thermometer in your oven. Arcing may occur. Microwave safe thermometers are available for both meat and candy.

9) BABY FORMULA / BABY FOOD

- **DO NOT** heat baby formula or baby food in the microwave oven. The glass jar or surface of the food may appear warm while the interior can be so hot as to burn the infant's mouth and esophagus.

10) REHEATING PASTRY PRODUCTS

- When reheating pastry products, check temperatures of any fillings before eating. Some foods have fillings which heat faster and can be extremely hot, while the surface remains warm to the touch (ex. Jelly Donuts).

11) GENERAL OVEN USAGE GUIDELINES

- **DO NOT** use the oven for any purpose other than the preparation of food.



Cookware Guide

ITEM	MICROWAVE	COMMENTS
Aluminum Foil	Yes for Shielding only	Small strips of foil can be molded around thin parts of meat or poultry to prevent overcooking. Arcing can occur if foil is too close to oven wall or door and damage to your oven will result.
Browning Dish	Yes	Browning dishes are designed for microwave cooking only. Check browning dish information for instructions and heating chart. Do not preheat for more than 6 minutes.
Brown paper bags	No	May cause a fire in the oven.
Dinnerware: Labeled "Microwave Safe"	Yes	Check manufacturers' use and care directions for use in microwave heating. Some dinnerware may state on the back of the dish, "Oven-Microwave Safe".
Unlabeled Dinnerware	?	Use CONTAINER TEST below.
Disposable polyester Paperboard Dishes	Yes	Some frozen foods are packaged in these dishes. Can be purchased in grocery stores.
Fast Food Carton with Metal Handle	No	Metal handle may cause arcing.
Frozen Dinner Tray Metal	No	Metal can cause arcing and damage to your oven.
Frozen Dinner Tray Microwave safe	Yes	Heat only 1 tray in the oven at one time.
Glass Jars	No	Most glass jars are not heat resistant. Do not use for cooking or reheating.
Heat Resistant Oven Glassware & Ceramics	Yes	Ideal for microwave cooking and browning. (See CONTAINER TEST below)
Metal Bakeware	No	Not recommended for use in microwave ovens. Metal can cause arcing and damage to your oven.
Metal Twist-Ties	No	May cause arcing which could cause a fire in the oven.
Oven Cooking Bag	Yes	Follow manufacturers' directions. Close bag with the nylon tie provided, a strip cut from the end of the bag, or a piece of cotton string. Do not close with metal twist-tie. Make six ½-inch (1 cm) slits near the closure.
Paper Plates & Cups	Yes	Use to warm cooked foods, and to cook foods that require short cooking times such as hot dogs.
Paper Towels & Napkins	Yes	Use to warm rolls and sandwiches, only if labeled safe for microwave use.
Recycled Paper Towels & Napkins	No	Recycled paper products may contain impurities which may cause sparks.
Parchment Paper	Yes	Use as a cover to prevent spattering. Safe for use in microwave, microwave/convection and conventional ovens.
Plastic: Microwave Safe Cookware	Yes use caution	Should be labeled, "Suitable for Microwave Heating." Check manufacturers' directions for recommended uses. Some microwave safe plastic containers are not suitable for cooking foods with high fat or sugar content. The heat from hot food may cause the plastic to warp.
Plastic, Melamine	No	This material absorbs microwave energy. Dishes get HOT!
Plastic Foam Cups	Yes use caution	Plastic foam will melt if foods reach a high temperature. Use to reheat foods to a low serving temperature only.
Plastic Wrap	Yes	Use to cover food during cooking to retain moisture and prevent spattering. Should be labeled "Suitable for Microwave Heating". Check package directions.
Straw, Wicker, Wood	Yes use caution	Use only for short term reheating and to bring food to a low serving temperature. Wood may dry out & split or crack when used.
Thermometers-Microwave safe	Yes	Use only microwave safe meat and candy thermometers.
Thermometers-Conventional	No	Not suitable for use in microwave oven, will cause sparks and get hot.
Wax paper	Yes	Use as a cover to prevent spattering and to retain moisture.

CONTAINER TEST

TO TEST A CONTAINER FOR SAFE MICROWAVE OVEN USE: Fill a microwave safe cup with cool water and place it in the microwave oven alongside the empty container to be tested; **heat one (1) minute at P10 (HIGH)**. If the container is microwave oven safe (transparent to microwave energy), the empty container should remain comfortably cool and the water should be hot. If the container is hot, it has absorbed some microwave energy and should NOT be used. This test cannot be used for plastic containers.

Oven Components Diagram

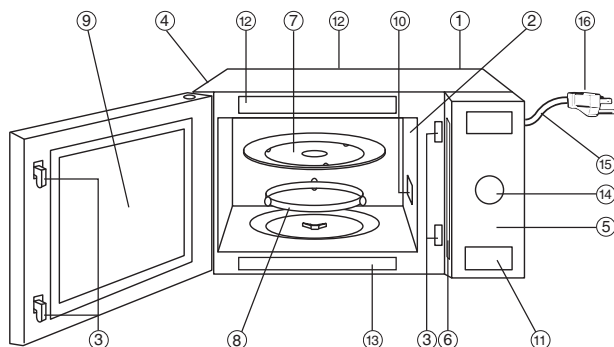

- ① **External Air Vent**
- ② **Internal Air Vent**
- ③ **Door Safety Lock System**
- ④ **Exhaust Air Vent**
- ⑤ **Control Panel**
- ⑥ **Identification Plate**
- ⑦ **Glass Tray**
- ⑧ **Roller Ring**
- ⑨ **Heat/Vapor Barrier Film**
(do not remove)
- ⑩ **Waveguide Cover** (do not remove)
- ⑪ **Door Release Button**
- ⑫ **Warning Label**
- ⑬ **Function Label**
- ⑭ **Time/Weight and Sensor Menu Dial**
- ⑮ **Power Supply Cord**
- ⑯ **Power Supply Plug**

Control Panel

The light on control panel will prompt you to turn dial or press **Start**.

* The control panel of NN-SD975S/SD775 has the same key layout.

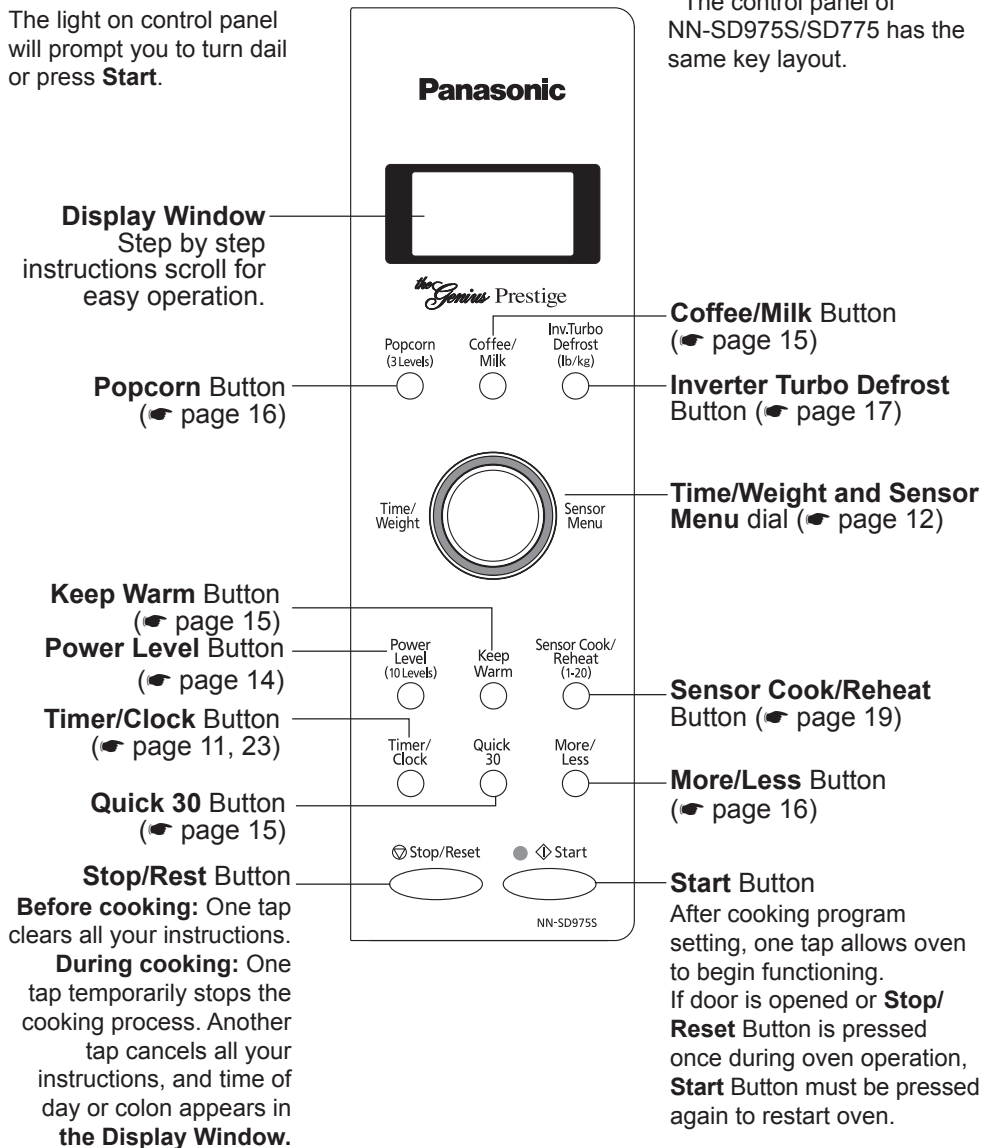

Display Window
Step by step instructions scroll for easy operation.

Popcorn Button
(☛ page 16)

Coffee/Milk Button
(☛ page 15)

Inverter Turbo Defrost Button
(☛ page 17)

Time/Weight and Sensor Menu dial
(☛ page 12)

Keep Warm Button
(☛ page 15)
Power Level Button
(☛ page 14)

Sensor Cook/Reheat Button
(☛ page 19)

Timer/Clock Button
(☛ page 11, 23)

More/Less Button
(☛ page 16)

Quick 30 Button
(☛ page 15)

Stop/Rest Button
Before cooking: One tap clears all your instructions.
During cooking: One tap temporarily stops the cooking process. Another tap cancels all your instructions, and time of day or colon appears in the **Display Window**.

Start Button
After cooking program setting, one tap allows oven to begin functioning. If door is opened or **Stop/Reset** Button is pressed once during oven operation, **Start** Button must be pressed again to restart oven.

Beep Sound:



When a button is pressed correctly, a beep will be heard.

If a button is pressed and no beep is heard, the unit did not or cannot accept the instruction. When operating, the oven will beep twice between programmed stages. At the end of any complete program, the oven will beep 5 times.



Notes:

- If there is no operation for 6 minutes after setting cooking program, the oven will automatically cancel the cooking program. The display will return to clock or colon display.
- If no beep sound is heard, check "Beep ON/OFF" function feature (P12, 13).

Starting to Use Your Oven

<p>1.</p>  <p>↓</p> <p>Display Window</p> <p>↓</p> 	<ul style="list-style-type: none"> • Plug into a properly grounded electrical outlet. • “WELCOME TO PANASONIC REFER TO OPERATING INSTRUCTIONS BEFORE USE” scrolls across display window.
---	---

Setting the Clock



<p>1. Timer/Clock</p> 	<ul style="list-style-type: none"> • Press Timer/Clock twice. ▶ Colon flashes.
<p>2. Time Dial</p>  <p>Rotate</p>	<ul style="list-style-type: none"> • Set time of day using Time Dial. ▶ Time appears in the display window; colon continues flashing.
<p>3. Timer/Clock</p> 	<ul style="list-style-type: none"> • Press Timer/Clock. ▶ Colon stops flashing; time of day is entered.

NOTES:

1. To reset the clock, repeat step 1-3.
2. The clock will retain the time of day as long as the oven is plugged in and electricity is supplied.
3. Clock is a 12-hour display.
4. Oven will not operate while colon is flashing.

Child Safety Lock

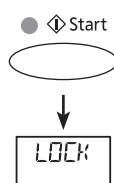
This feature prevents the electronic operation of the oven until cancelled. It does not lock the door.

<p>To set:</p> 	<ul style="list-style-type: none"> • Press Start 3 times. • “LOCK” appears in the display window. ▶ “LOCK” continues to be displayed until Child Safety Lock is cancelled. Keypads may be pressed but the microwave will not start.
<p>To cancel:</p> 	<ul style="list-style-type: none"> • Press Stop/Reset 3 times. ▶ The display will return to colon or time of day when Child Lock has been cancelled.

NOTES:

1. You can set the Child Lock feature when the display shows a colon or time of day.
2. To set or cancel child safety lock, **Start** or **Stop/Reset** button must be pressed 3 times within 10 seconds.



Dial Features



- **TIME CHOICE**
Rotate the dial clockwise to increase the cooking time and rotate the dial counter-clockwise to decrease the cooking time.
- **WEIGHT CHOICE**
Rotate the dial clockwise to increase the weight and rotate the dial counter-clockwise to decrease the weight setting.
- **SENSOR MENU CHOICE**
Dial can be rotated in either direction to select the Sensor Menus.



Function Features









This unique function of your Panasonic microwave oven allows you to establish the initial non-cooking features of your Oven.

This microwave oven has three functions below:

LB/KG CHOICE: The oven has both imperial and metric weight measurements.

LANGUAGE CHOICE: The oven has a choice of English, French or Spanish display.

BEEP CHOICE: The oven has both Beep On and Beep Off mode.

  Plug into a properly grounded electrical outlet.		
LB/KG CHOICE	LANGUAGE CHOICE	BEEP CHOICE
<p>● ⬆ Start</p>  <ul style="list-style-type: none"> • Press Start once. The oven automatically defaults to the imperial measure system (LB). <p style="text-align: center;">↓</p>  <ul style="list-style-type: none"> • Rotate the dial to choose metric weight measurements (KG). 	<p>● ⬆ Start</p>  <ul style="list-style-type: none"> • Press Start twice. The default display language is English. <p style="text-align: center;">↓</p> <p style="text-align: center;">More/ Less</p>  <ul style="list-style-type: none"> • Press More/Less once. The display language changes to French. • Press More/Less twice. The display language changes to Spanish. 	<p>● ⬆ Start</p>  <ul style="list-style-type: none"> • Press Start 3 times. The default mode is Beep On. <p style="text-align: center;">↓</p> <p style="text-align: center;">Timer/ Clock</p>  <ul style="list-style-type: none"> • Press Timer/Clock once. The mode changes to Beep Off.
Press other button to exit.		







- NOTES:** 1. These choices can be selected only when you plug-in the oven.
2. Press **Stop/Reset** button to select default setting.



Function Features

(continued)

Set LB/KG, Language and BEEP by following the steps below:

1. 	<ul style="list-style-type: none"> • Plug into a properly grounded electrical outlet.
2. 	<ul style="list-style-type: none"> • Press Start once.
3. 	<ul style="list-style-type: none"> • Rotate the dial to choose metric weight measurements (KG).
4. 	<ul style="list-style-type: none"> • Press Start once to set Language.
5. 	<ul style="list-style-type: none"> • Press More/Less once. The display language changes to French. • Press More/Less twice. The display language changes to Spanish.
6. 	<ul style="list-style-type: none"> • Press Start once to Beep Choice.
7. 	<ul style="list-style-type: none"> • Press Timer/Clock once. The mode changes to Beep Off.
<p>NOTE: After setting, it will revert back to LB/KG setting if Start button is pressed again, press other button to exit.</p>	

MENU ACTION ON/OFF (can be selected when colon or clock appears in the display window) MENU ACTION SCREEN helps you to program your oven by prompting the next step to be taken. When you become familiar with your oven, the prompt can be turned off.

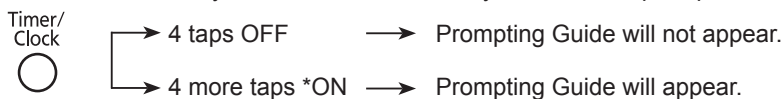

DEMO MODE ON/OFF

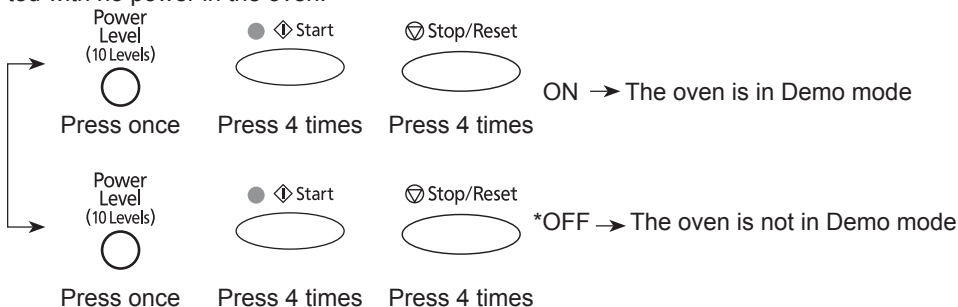

Demo mode is designed for retail store display. In this mode, the oven can be demonstrated with no power in the oven.



* DEFAULT MODE

Selecting Power & Cook Time

Example: To cook at P6 (MEDIUM) power for 1 minute 30 seconds

1. Power Level (10 Levels)  Press 5 times	<ul style="list-style-type: none"> Press Power Level until the desired power level appears in the display window.
2. Time Dial  Rotate	<ul style="list-style-type: none"> Set Cooking Time using Time Select Dial to 1 minute and 30 seconds.
3.  Start	<ul style="list-style-type: none"> Press Start. ►Cooking will start. The time in the display window will count down.

Press	Power Level
once	P10 (HIGH)
twice	P9
3 times	P8
4 times	P7 (MEDIUM-HIGH)
5 times	P6 (MEDIUM)
6 times	P5
7 times	P4
8 times	P3 (MEDIUM-LOW)/DEFROST
9 times	P2
10 times	P1 (LOW)

NOTES:







- When selecting P10 (HIGH) power for the first stage, you may begin at step 2.
- When selecting P10 (HIGH) power, the maximum programmable time is 30 minutes. For other power levels, the maximum time is 1 hour and 30 minutes.
- For reheating, use P10 (HIGH) for liquids, P7 (MEDIUM-HIGH) for most foods and P6 (MEDIUM) for dense foods.
- For defrosting, use P3 (MEDIUM-LOW).

DO NOT OVERCOOK. This oven requires less time to cook than an older unit. Overcooking will cause food to dry out and may cause a fire. A microwave oven's cooking power tells you the amount of microwave power available for cooking.

3-Stage Cooking

This feature allows you to program 2-3 Stages of cooking continuously.

Example: Continually set P10 for 5 minutes, P7 for 3 minutes and P4 for 5 minutes.

1. Power Level (10 Levels)  Press once	<ul style="list-style-type: none"> Enter the desired Power level.
2. Time Dial  Rotate	<ul style="list-style-type: none"> Set Cooking Time using Time Select Dial to 5 minutes.
3. Power Level (10 Levels)  Press 4 times	<ul style="list-style-type: none"> Enter the desired Power level.
4. Time Dial  Rotate	<ul style="list-style-type: none"> Set Cooking Time using Time Select Dial to 3minutes.
5. Power Level (10 Levels)  Press 7 times	<ul style="list-style-type: none"> Enter the desired Power level.
6. Time Dial  Rotate	<ul style="list-style-type: none"> Set Cooking Time using Time Select Dial to 5 minutes.
7.  Start	<ul style="list-style-type: none"> Press Start. ►Cook will start. The time in the display window will count down.

NOTES:





- The maximum number of stages for cooking is 3.
- When selecting P10 (HIGH) power for the first stage, you may begin at step 2.
- When operating, two beeps will sound between each stage.
- Inverter turbo defrost, sensor or other auto features can not be used with 3 stage cooking.



Keep Warm Feature

This feature will keep food warm for up to 30 minutes after cooking.

Example: To keep 2 cups of gravy warm

1. Keep Warm 	<ul style="list-style-type: none"> • Press Keep Warm.
2. Time Dial  Rotate	<ul style="list-style-type: none"> • Set warming time, up to 30 minutes.
3.  Start 	<ul style="list-style-type: none"> • Press Start. ➤ Keep Warm will start. The time in the display window will count down.

NOTE:



Keep Warm can be programmed as the final stage after cook times have been manually entered. It cannot be used in combination with inverter turbo defrost, sensor or other auto features.



Quick 30 Feature

This feature allows you to set or add cooking time in 30 seconds increments up to 5 minutes.

To Set Time using Quick 30:

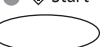

Example: To cook at P6 (MEDIUM) power for 1 minute 30 seconds	
1. Power Level (10 Levels)  Press 5 times	<ul style="list-style-type: none"> • Enter the desired Power level (see page 14 for directions).
2. Quick 30  Press 3 times	<ul style="list-style-type: none"> • Press Quick 30 until the desired cooking time (up to 5 minutes) appears in the display window.
2.  Start 	<ul style="list-style-type: none"> • Press Start. ➤ Cooking begins and the time will count down. At the end of cooking, 5 beeps sound.

NOTES:

1. When selecting P10 (HIGH) power for the first stage, you may begin at step 2.
2. After setting the time by **Quick 30** Pad, you cannot use Time Dial.

To Add Time using Quick 30:

Example: Add 3 minutes.

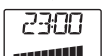



 ↓ Quick 30  Press 6 times ↓ 	<ul style="list-style-type: none"> • During manual cooking, press Quick 30 until the desired cooking time (up to 5 minutes) appears in the display window.
--	--



Coffee/Milk Feature

This feature allows you to reheat coffee/milk without setting power and time.

Example: To reheat 2 cup coffee.

1. Coffee/Milk  Press twice.	<ul style="list-style-type: none"> • Press Coffee/Milk until the desired menu appears in the display window. <table border="1"> <thead> <tr> <th>Press</th> <th>Menu</th> </tr> </thead> <tbody> <tr> <td>once</td> <td>1 cup coffee</td> </tr> <tr> <td>twice</td> <td>2 cups coffee</td> </tr> <tr> <td>3 times</td> <td>1 cup milk</td> </tr> <tr> <td>4 times</td> <td>2 cups milk</td> </tr> </tbody> </table>	Press	Menu	once	1 cup coffee	twice	2 cups coffee	3 times	1 cup milk	4 times	2 cups milk
Press	Menu										
once	1 cup coffee										
twice	2 cups coffee										
3 times	1 cup milk										
4 times	2 cups milk										
2. More/Less  Optional	<ul style="list-style-type: none"> • (see More/Less Feature.) (☛ page 16) 										
3.  Start 	<ul style="list-style-type: none"> • Press Start. ➤ Reheat will start. The time in the display window will count down. 										



NOTES:

1. Use a microwave safe cup.
2. Heated coffee/milk can erupt if not mixed with air. Do not heat coffee/milk in your microwave oven without stirring before and halfway through heating.
3. Care must be exercised not to overheat coffee/milk when using the Coffee/Milk feature. It is programmed to give proper result when heating 1 cup or 2 cups of coffee/milk, starting from room temperature for coffee and refrigerator temperature for milk. Overheating will cause an increased risk of scalding, or water eruption. Refer to page 3, item 18.
4. 1 cup of milk is 200 ml to 250 ml and 1 cup of coffee is 150 ml to 200 ml.



Popcorn Feature

Example: To pop 3.5 oz. (99 g) of popcorn

<p>1.</p> <p>Popcorn (3 Levels)</p>  <p>Press once.</p>	<ul style="list-style-type: none"> Press Popcorn until the desired size appears in the display window. <table border="1" data-bbox="337 385 589 505"> <thead> <tr> <th>Press</th> <th>Weight</th> </tr> </thead> <tbody> <tr> <td>once</td> <td>3.5 oz. (99 g)</td> </tr> <tr> <td>twice</td> <td>2.75 oz. (78 g)</td> </tr> <tr> <td>3 times</td> <td>1.5 oz. (42 g)</td> </tr> </tbody> </table>	Press	Weight	once	3.5 oz. (99 g)	twice	2.75 oz. (78 g)	3 times	1.5 oz. (42 g)
Press	Weight								
once	3.5 oz. (99 g)								
twice	2.75 oz. (78 g)								
3 times	1.5 oz. (42 g)								
<p>2.</p> <p>More/ Less</p>  <p>Optional</p>	<ul style="list-style-type: none"> (see More/Less Feature.) 								
<p>3.</p> <p>Start</p> 	<ul style="list-style-type: none"> Press Start. ▶ After several seconds, cooking time appears in the display window and begins to count down. 								

NOTES ON POPCORN FEATURE:

1. Pop one bag at a time.
2. Place bag in oven according to manufacturers' directions.
3. Start with popcorn at room temperature.
4. Allow popped corn to sit unopened for a few minutes.
5. Open bag carefully to prevent burns, because steam will escape.
6. Do not reheat unpopped kernels or reuse bag.

NOTE:

If popcorn is of a different weight than listed, follow instructions on popcorn package. **Never leave the oven unattended.** If popping slows to 2 to 3 seconds between pops, stop oven. **Overcooking can cause fire.**

REMARKS:

When popping multiple bags one right after the other, the cooking time may vary slightly. This does not affect the popcorn results.



More/Less Feature

For Popcorn:

By using the **MORE/LESS** Button, the programs can be adjusted to cook popcorn for a longer or shorter time if desired.

- 1 tap = Adds approx. 10 secs.
- 2 taps = Adds approx. 20 secs.
- 3 taps = Subtracts approx. 10 secs.
- 4 taps = Subtracts approx. 20 secs.
- 5 taps = Original setting

Press **More/Less** Button before pressing **Start**.

For Sensor Reheat/Cook and Coffee/Milk:

Preferences for food doneness vary with each individual. After having used the **Sensor Reheat/Cook and Coffee/Milk** feature a few times, you may decide you would prefer your food cooked to a different doneness.

For Sensor Reheat/Cook:

- 1 tap = More (Adds approx. 20% time)
- 2 taps = Less (Subtracts approx. 20% time)
- 3 taps = Original setting

For Coffee/Milk:

- 1 tap = More (Adds approx. 10% time)
- 2 taps = Less (Subtracts approx. 10% time)
- 3 taps = Original setting

Press **More/Less** Button before pressing **Start**.





Inverter Turbo Defrost Feature

This feature allows you to automatically defrost foods such as: meat, poultry and seafood simply by entering the weight.

Example: To Defrost 1.5 pounds of meat

Place food on microwave safe dish.

1. Inv.Turbo Defrost (lb/kg) 	<ul style="list-style-type: none"> • Press Inverter Turbo Defrost.
2. Weight Dial  Rotate	<ul style="list-style-type: none"> • Set weight of the food, using the Weight Dial to 1.5 pounds.
3. 	<ul style="list-style-type: none"> • Press Start. ▶ Defrosting will start. The time will count down. Larger weight foods will cause a signal midway through defrosting. If 2 beeps sound, turn over, rearrange foods or shield with aluminum foil.

Conversion Chart:

Follow the chart to convert ounces or hundredths of a pound into tenths of a pound. To use Inverter Turbo Defrost, enter the weight of the food in lbs. (1.0) and tenths of a lb. (0.1). If a piece of meat weighs 1.95 lbs. or 1 lb. 14 oz., enter 1.9 lbs.

Ounces	Hundredths of a Pound	Tenths of a Pound
0	.01 - .05	0.0
1 - 2	.06 - .15	0.1
3 - 4	.16 - .25	0.2
5	.26 - .35	0.3
6 - 7	.36 - .45	0.4
8	.46 - .55	0.5
9 - 10	.56 - .65	0.6
11 - 12	.66 - .75	0.7
13	.76 - .85	0.8
14 - 15	.86 - .95	0.9

Note:

The maximum weight for Inverter Turbo Defrost is 6 lb (3 kg).



Defrosting Tips & Techniques

Preparation for freezing:

1. Freeze meats, poultry, and fish in packages with only 1 or 2 layers of food. Place wax paper between layers.
2. Package in heavy-duty plastic wraps, bags (labeled "For Freezer"), or freezer paper.
3. Remove as much air as possible.
4. Seal securely, date, and label.

To Defrost:

1. Remove wrapper. This helps moisture to evaporate. Juices from food can get hot and cook the food.
2. Set food in microwave-safe dish.
3. Place roasts fat-side down. Place whole poultry breast-side down.
4. Select power and minimum time so that items will be under-defrosted.
5. Drain liquids during defrosting.
6. Turn over (invert) items during defrosting.
7. Shield edges and ends if needed. (See Cooking Techniques).

After Defrosting:

1. Large items may be icy in the centre. Defrosting will complete during STANDING TIME.
2. Let stand, covered, following stand time directions on page 18.
3. Rinse foods as indicated in the chart.
4. Items which have been layered should be rinsed separately or have a longer stand time.



Defrosting Tips & Techniques *(continued)*





FOOD	DEFROST TIME at P3 mins (per lb)	DURING DEFROSTING	AFTER DEFROSTING	
			Stand Time	Rinse
Fish and Seafood				
Crabmeat [up to 3 lbs. (1.4 kg)]	6	Break apart/Rearrange	5 min.	YES
Fish Steaks	4 to 6	Turn over		
Fish Fillets	4 to 6	Turn over/Rearrange/Shield ends		
Sea Scallops	4 to 6	Break apart/ Remove defrosted pieces		
Whole fish	4 to 6	Turn over		
Meat				
Ground Meat	4 to 5	Turn over/Remove defrosted portion/Shield edges	10 min.	NO
Roasts [2½-4 lbs. (1.1-1.8 kg)]	5 to 8	Turn over/Shield ends and defrosted surface	30 min. in refrig.	
Chops/Steak	6 to 8	Turn over/Rearrange/Shield ends and defrosted surface	5 min.	
Ribs/T-bone	6 to 8	Turn over/Rearrange/Shield ends and defrosted surface		
Stew Meat	4 to 8	Break apart/Rearrange/ Remove defrosted pieces		
Liver (thinly sliced)	4 to 6	Drain liquid/Turn over/ Separate pieces		
Bacon (sliced)	4	Turn over	---	
Poultry				
Chicken, Whole [up to 3 lbs. (1.4 kg)]	4 to 6	Turn over/Shield	20 min. in refrig.	YES
Cutlets	4 to 6	Break apart/Turn over/ Remove defrosted Pieces	5 min.	
Pieces	4 to 6	Break apart/Turn over/Shield	10 min.	
Cornish hens	6 to 8	Turn over/Shield	20 min. in refrig.	
Turkey Breast [5-6 lbs. (2.3-2.7 kg)]	6	Turn over/Shield		



Sensor Reheat Feature

This sensor feature allows you to reheat food without setting time. The oven simplifies programming.

Example: To reheat a plate of food

1. Sensor Cook/ Reheat (1-20) 	<ul style="list-style-type: none"> Press Sensor Cook/ Reheat.
2. Sensor Menu Dial  Rotate	<ul style="list-style-type: none"> Select the Sensor Reheat using the Sensor Menu Select Dial.
3. More/ Less  Optional	<ul style="list-style-type: none"> (see More/Less Feature.) (☛ page 16)
4. ● ◀ Start 	<ul style="list-style-type: none"> Press Start. ▶ Cooking starts.

Cooking is complete when 5 beeps sound. (When steam is detected by the Genius Sensor and 2 beeps sound, the remaining cooking time will appear in the display window.)

NOTE:

Casseroles - Add 3 to 4 tablespoons of liquid, cover with lid or vented plastic wrap. Stir when time appears in the display window.

Canned foods - Empty contents into casserole dish or serving bowl, cover dish with lid or vented plastic wrap. After reheating, let stand for a few minutes.

Plate of food - Arrange food on plate; top with butter, gravy, etc. Cover with lid or vented plastic wrap. After reheating, let stand for a few minutes.

DO NOT USE SENSOR REHEAT





- To reheat bread, meat pie and pastry products. Use manual power and time for these foods.
- For raw or uncooked foods.
- If oven cavity is warm.
- For beverages.
- For frozen foods.



Sensor Cook Feature

This sensor feature allows you to cook food without setting time. The oven simplifies programming.

Example: To cook Frozen Entrées

1. Sensor Cook/ Reheat (1-20) 	<ul style="list-style-type: none"> Press Sensor Cook/ Reheat.
2. Sensor Menu Dial  Rotate	<ul style="list-style-type: none"> Select the desired sensor menu using the Sensor Menu Select Dial.
3. More/ Less  Optional	<ul style="list-style-type: none"> (see More/Less Feature.) (☛ page 16)
4. ● ◀ Start 	<ul style="list-style-type: none"> Press Start. ▶ Cooking starts.

Cooking is complete when 5 beeps sound. (For some menus, when steam is detected by the Genius Sensor and 2 beeps sound, the remaining cooking time will appear in the display window.)

For the best results with the **GENIUS SENSOR**, follow these recommendations.

BEFORE Reheating/Cooking:

- The room temperature surrounding the oven should be below 95 °F (35 °C).
- Food weight should exceed 4 oz. (110 g).
- Be sure the glass tray, the outside of the cooking containers and the inside of the microwave oven are dry before placing food in the oven. Residual beads of moisture turning into steam can mislead the sensor.
- Cover food with lid, or with vented plastic wrap. Never use tightly sealed plastic containers—they can prevent steam from escaping and cause food to overcook.

DURING Reheating/Cooking:

DO NOT open the oven door until beeps sound. Doing so will cause inaccurate cooking since the steam from food is no longer contained within the oven cavity. Once the cooking time begins to count down, the oven door may be opened to stir, turn or rearrange foods for some menus.

AFTER Reheating/Cooking:

All foods should have a stand time.



Sensor Cook Chart

Recipe	Serving/Weight	Hints
1. Sensor Reheat	4 - 16 oz. (110 - 450 g)	All foods, such as casseroles, plated dinners, soups, stews, pasta dishes (except lasagne) and canned foods, must be pre-cooked. Foods should be reheated from refrigerator or room temperature, do not reheat frozen foods on this setting. Do not reheat in foil or plastic containers as unsuccessful reheating times will result. All foods should be covered securely with vented plastic wrap or a fitting lid. Where possible after heating, stir foods and stand covered for 3 to 5 minutes before serving.
2. Oatmeal	0.5 - 1 cup (40 - 80 g)	Place inside a microwave safe serving bowl with no cover. Follow manufacturers' directions for preparation.
3. Breakfast Sausage	2 - 8 links	Follow manufacturers' directions for preparation of precooked breakfast sausage. Place in a radial pattern.
4. Omelet	2 - 4 eggs	Follow Basic Omelet recipe on page 22.
5. Quinoa	¼ - 1 cups (45 - 180 g)	Place quinoa in a microwave safe 3 qt casserole dish. Add 2 parts water to 1 part quinoa. Cover with lid or vented plastic wrap. After 2 beeps, stir. Let stand 14 minutes before serving.
6. Soup	1 - 2 cups (250 - 500 ml)	Pour soup into a microwave safe serving bowl. Cover with vented plastic wrap. Stir after cooking.
7. Frozen Entrées	8 - 28 oz. (220 - 800 g)	Follow manufacturers' directions for preparation. After 2 beeps, stir or rearrange. Be careful when removing the film cover after cooking. Remove facing away from you to avoid steam burns. If additional time is needed, continue to cook manually.
8. Frozen Pizza (single)	8 oz. (220 g)	Follow manufacturers' directions for preparation. Add more time of cooking if needed.
9. Frozen Pocket Sandwich	1 sandwich (4.5 oz.) (128 g)	Follow manufacturer's directions for preparation.
10. Potatoes (pierce skin)	1 - 4 potatoes (6 - 8 oz. each) (170 - 220 g)	Pierce each potato with a fork 6 times spacing around surface. Place potato or potatoes around the edge of paper-towel-lined glass tray (Turntable), at least 1 inch (2.5 cm) apart. Do not cover. Turn over after 2 beeps. Let stand 5 minutes to complete cooking.
11. Fresh Vegetables	4 - 16 oz. (110 - 450 g)	All pieces should be the same size. Wash thoroughly, add 1 tbsp of water per ½ cup of vegetables, and cover with lid or vented plastic wrap. Do not salt/butter until after cooking.



Sensor Cook Chart *(continued)*

Recipe	Serving/Weight	Hints
12. Frozen Vegetables	6 - 16 oz. (170 - 450 g)	Wash thoroughly, add 1 tbsp. of water per ½ cup of vegetables, and cover with lid or vented plastic wrap. After 2 beeps, stir or rearrange. Do not salt/butter until after cooking. (Not suitable for vegetables in butter or sauce.)
13. Canned Vegetables	15 oz. (430 g)	Empty contents into microwave safe serving bowl. Do not cover.
14. White Rice	½ - 1½ cups (110 - 335 g)	Place rice with hot tap water in a microwave safe casserole dish. Cover with lid or vented plastic wrap. Let stand 5 to 10 minutes before serving.
15. Brown Rice	½ - 1½ cups (110 - 335 g) (maximum)	Place rice with hot tap water in a microwave safe casserole dish. Cover with lid or vented plastic wrap. Let stand 5 to 10 minutes before serving.
16. Frozen Dinners	11 - 16 oz. (300 - 450 g)	Follow manufacturers' directions for covering or removing covers. Do not use frozen foods packaged in foil trays. After 2 beeps, stir or rearrange.
17. Pasta	2 - 8 oz. (55 - 220 g)	Place 2 oz. pasta and 3 cups hot tap water in a microwave safe 2 qt casserole, salt and oil, if desired, covered with lid or vented plastic wrap. For 4 oz. pasta use 4 cups water, for 6 oz. pasta use 6 cups water in 3 qt casserole, for 8 oz. pasta use 7 cups water.
18. Stew	4 Serv.	In a 3 qt casserole dish, crumble 1 pound (450 g) lean ground beef and stir in 2 medium onions (chopped), ¼ teaspoon dried garlic pieces. Cover with plastic wrap and cook on P10 for 6 minutes. Stir after cooking. Drain. Add 16 oz. (450 g) pinto or red kidney beans, 15 oz (425 g) stewed tomatoes (chopped), 15 oz (425 g) tomato sauce, 1 teaspoon salt and 2 to 3 tablespoons chili powder. Cover with lid, using Stew selection. After 2 beeps, stir. Recover and touch Start. Stir after cooking. Cover again and let stand 7 minutes before serving.
19. Ground Meat	16 - 32 oz (450 - 900 g.)	Break apart in glass bowl or colander. Cover with lid or vented plastic wrap. After 2 beeps, stir. Recover and touch Start. Juices should be clear. Drain.
20. Fish Fillets	4 - 16 oz. (110 - 450 g)	Arrange in a single layer. Cover with lid or vented plastic wrap.



Microwave Recipes

OMELET

Basic Omelet

- 1 tablespoon butter or margarine
- 2 eggs
- 2 tablespoons milk
- salt and ground black pepper, if desired

Heat butter in a microwave safe 9-inch pie plate, 20 seconds at P10, or until melted. Turn the plate to coat the bottom with butter. Meanwhile, combine the remaining ingredients in a separate bowl, beat together and pour into the pie plate. Cook, covered with vented plastic wrap, using OMELET selection. Let stand 2 minutes. With a spatula, loosen the edges of the omelet from the plate, fold into thirds to serve. **Always use scrambled eggs.**

Yield: 1 serving

Approx. Cooking Time: 4 minutes.

NOTE: Double ingredients for a 4 egg Omelet.

Spicy mango chutney

- 2 cups mango, peeled, seed removed, diced
- ½ cup dark brown sugar
- 2 tablespoon cider vinegar
- ½ cup raisins
- 1 tablespoon jalapeno, minced
- 1 tablespoon garlic, minced
- 1 tablespoon ginger, minced
- ¼ teaspoon salt
- ¼ teaspoon black Pepper

Combine all the ingredients in a 2 qt. microwave dish. Cover with plastic wrap, then puncture holes with a small knife, for steam to vent and microwave for at P10 for 6 minutes. Let cool, cover and keep refrigerated until needed.

Yield: 2 cups

Macaroni and Cheese

- ¼ cup butter
- 2 tablespoons chopped onion
- 1 clove minced garlic
- ¼ cup all-purpose flour
- 1 teaspoon dry mustard
- 1 teaspoon salt
- ¼ teaspoon ground black pepper
- 2 cups milk
- 2 cups grated cheddar cheese
- 8 oz. (½ lb. dry weight) macaroni, cooked and drained
- ⅓ cup bread crumbs
- 1 teaspoon paprika

In a 2-Qt. casserole, melt the butter for 40 seconds at P10. Add onion and garlic and cook for 1 minute at P10. Stir in flour,

mustard, salt and pepper, and gradually add the milk. Cook for 3-4 minutes at P10 until sauce thickens, stirring once. Add the cheddar cheese, stirring thoroughly. Pour and stir the sauce into the macaroni, in a 3-Qt. casserole. Top with bread crumbs and paprika. Cover with lid or vented plastic wrap. Cook at P6 power for 16-18 minutes.

Yield: 6 servings

North carolina barbecued pulled pork

- 2 tablespoon brown sugar
- 1 tablespoon paprika
- 1 tablespoon chili powder
- 1 tablespoon dry mustard
- 1 tablespoon red pepper flakes
- ½ cup cider vinegar
- ¼ cup white vinegar
- ½ cups ketchup 1
- 2 tablespoon worcestershire sauce
- 1 tablespoon tabasco sauce
- 1 tablespoon sugar
- 1 teaspoon salt
- 1 teaspoon black Pepper

680 g (1 ½ lb.) pork butt
Combine all ingredients, except for the pork, in a 1 qt. microwave container and microwave covered for 1 minute. Place pork butt into a large round microwave dish. Pour barbecue sauce over pork and cover. Microwave at P4 for 90 minutes until meat starts to come apart very easily when separating with a fork. (Baste the pork every 20 minutes and check on consistency of barbecue sauce. If barbecue sauce becomes thick, dilute with 1-2 tablespoons of water).

Yield: 4 Portions

Quinoa salad

- 1 cup Quinoa
- 1 cucumber (cut into ½ inch cube)
- 1 tomatoes (remove seed and cut into ½ inch cube)
- ¼ cup (10 g) parsley, chopped
- ⅓ cup (30 g) your choice of roasted nuts (e.g. sliced almond, sunflower seeds)
- 2 tablespoon (20 g) dry fruits (e.g. cranberry, raisin)
- ⅓ cup (40 g) your choice of cheese (optional, cut into ½ inch cube)
- 4 tablespoon olive oil
- 1 tablespoon rime or lemon juice
- salt and pepper to taste

Cook quinoa by Auto function. After cooking, stand for 13-15 minutes. Mix all ingredients well, and Serve warm or chilled.





Timer Feature

This feature allows you to program the oven as a kitchen timer. It can also be used to program a standing time after cooking is completed and/or to program a delay start.





To Use as a Kitchen Timer:

Example: To count down 5 minutes.

1.  Timer/ Clock	• Press Timer/Clock once.
2.  Rotate	• Set time, using Time Dial to 5 minutes.
3.  Start	• Press Start . ▶ Time will count down without oven operations.

To Set Stand Time:

Example: To cook at P6 power for 3 minutes, with stand time of 5 minutes.





1.  Press 5 times	• Enter the desired Power level (see page 14 for directions).
2.  Rotate	• Set cooking time, using Time Select Dial to 3 minutes.
3.  Timer/ Clock	• Press Timer/Clock once.
4.  Rotate	• Set stand time, using Time Dial to 5 minutes.
5.  Start	• Press Start . ▶ Cooking will start. After cooking, stand time will count down without oven operating.

CAUTION:

If oven lamp is lit while using the timer feature, the oven is incorrectly programmed. Stop oven immediately and re-read instructions.

To Set Delay Start:

Example: To delay the start of cooking for 5 minutes, and cook at P6 power for 3 minutes.

1.  Timer/ Clock	• Press Timer/Clock once.
2.  Rotate	• Set delay time, using Time Select Dial to 5 minutes.
3.  Press 5 times	• Enter the desired Power level (see page 14 for directions).
4.  Rotate	• Set cooking time, using Time Dial to 3 minutes.
5.  Start	• Press Start . ▶ Delay time will count down. Then cooking will start.

NOTES:

1. When each stage finishes, a two-beep signal sounds. At the end of the program, the oven will beep five times.
2. If the oven door is opened during Stand Time, Kitchen Timer or Delay Time, the time in the display will continue to count down.
3. Stand time and Delay start cannot be programmed before inverter turbo defrost, sensor or other auto features. This is to prevent the starting temperature of food from rising before defrosting or cooking begins. A change in starting temperature could cause inaccurate results.
4. The maximum programmable time of Standing Time, Kitchen Time or Delay Time is up to 90 minutes



Microwave Shortcuts

FOOD	POWER	TIME (in mins.)	DIRECTIONS
To separate refrigerated Bacon , 1 pound (450 g)	P10 (HIGH)	30 sec.	Remove wrapper and place in microwave safe dish. After heating, use a plastic spatula to separate slices.
To soften Brown Sugar 1 cup (250 ml)	P10 (HIGH)	20 - 30 sec.	Place brown sugar in microwave safe dish with a slice of bread. Cover with lid or plastic wrap.
To soften refrigerated Butter , 1 stick, ¼ pound (110 g)	P3 (MED-LOW)	1	Remove wrapper and place butter in a microwave safe dish.
To melt refrigerated Butter , 1 stick, ¼ pound (110 g)	P6 (MEDIUM)	1½ - 2	Remove wrapper and place butter in a microwave safe dish covered with lid or vented plastic wrap.
To melt Chocolate , 1 square, 1 oz. (28 g)	P6 (MEDIUM)	1 - 1½	Remove wrapper and place chocolate in a microwave safe dish. After heating, stir until completely melted. <i>NOTE: Chocolate holds its shape even when softened.</i>
To melt Chocolate , ½ cup (125 ml) chips	P6 (MEDIUM)	1 - 1½	
To toast Coconut , ½ cup (125 ml)	P10 (HIGH)	1	Place in a microwave safe dish. Stir every 30 seconds.
To soften Cream Cheese , 8 oz. (220 g)	P3 (MED-LOW)	1 - 2	Remove wrapper and place in a microwave safe bowl.
To brown Ground Beef , 1 pound (450 g)	P10 (HIGH)	4 - 5	Crumble into a microwave safe colander set into another dish. Cover with plastic wrap. Stir twice. Drain grease.
To cook Vegetables , Fresh (½ lb.) (225 g)	P8	3½ - 4	All pieces should be the same size. Wash thoroughly, add 1 tbsp of water per ½ cup of vegetables, and cover with lid or vented plastic wrap. Do not salt/butter until after cooking.
Frozen (10 oz.) (280 g)	P8	3½ - 4	Wash thoroughly, add 1 tbsp of water per ½ cup of vegetables, and cover with lid or vented plastic wrap. Do not salt/butter until after cooking. (Not suitable for vegetables in butter or sauce.)
Canned (15 oz.) (430 g)	P8	3½ - 4	Empty contents into microwave safe serving bowl. Do not cover.



Microwave Shortcuts *(continued)*

FOOD	POWER	TIME (in mins.)	DIRECTIONS
To cook baked Potato , (6 - 8 oz. each) (170 - 220 g)			
1	P8	3½ - 4	Pierce each potato with a fork 6 times spacing around surface. Place potato or potatoes around the edge of paper-towel-lined glass tray (Turntable), at least 1 inch (2.5 cm) apart. Do not cover. Let stand 5 minutes to complete cooking.
2	P8	6 - 7	
To steam Hand Towels - 4	P10 (HIGH)	20 - 30 sec.	Soak in water, then wring out excess. Place on a microwave safe dish. Heat. Present immediately.
To soften Ice Cream , ½ gallon (2 L)	P3 (MED-LOW)	1 - 1½	Check often to prevent melting.
Cup of liquid To boil water, broth, etc.			Heated liquids can erupt if not stirred. Do not heat liquids in microwave oven without stirring before heating.
1 cup, 8 oz. (250 ml)	P10 (HIGH)	1½ - 2	
2 cups, 16 oz. (500 ml)	P10 (HIGH)	2½ - 3	
Cup of liquid To warm Beverage ,			Heated liquids can erupt if not stirred. Do not heat liquids in microwave oven without stirring before heating.
1 cup, 8 oz. (250 ml)	P7 (MED-HIGH)	1½ - 2	
2 cups, 16 oz. (500 ml)	P7 (MED-HIGH)	2½ - 3	
To roast Nuts , 1½ cups (375 ml)	P10 (HIGH)	3 - 4	Spread nuts into a 9-inch (23 cm) microwave safe pie plate. Stir occasionally.
To toast Sesame Seeds , ¼ cup (60 ml)	P10 (HIGH)	2 - 2½	Place in a small microwave safe bowl. Stir twice.
To skin Tomatoes , (one at a time)	P10 (HIGH)	30 sec.	Place tomato into a microwave safe bowl containing boiling water. Rinse and peel. Repeat for each tomato.
To remove Cooking Odours ,	P10 (HIGH)	5	Combine 1 to 1½ cups (250 - 375 ml) water with the juice and peel of one lemon in a 2 quart microwave safe bowl. After water finishes boiling, wipe interior of oven with a cloth. You can also use a combination of several whole cloves and ¼ cup of vinegar with 1 cup of water.

Food Characteristics

Bone and Fat

Both bone and fat affect cooking. Bones may cause irregular cooking. Meat next to the tips of bones may overcook while meat positioned under a large bone, such as a ham bone, may be undercooked. Large amounts of fat absorb microwave energy and the meat next to these areas may overcook.



Density

Porous, airy foods such as breads, cakes or rolls take less time to cook than heavy, dense foods such as potatoes and roasts. When reheating donuts or other foods with different centers be very careful. Certain foods have centers made with sugar, water, or fat and these centers attract microwaves (For example, jelly donuts). When a jelly donut is heated, the jelly can become extremely hot while the exterior remains warm to the touch. This could result in a burn if the food is not allowed to cool properly in the center.



Quantity

Two potatoes take longer to cook than one potato. As the quantity of the food decreases so does the cooking time. Overcooking will cause the moisture content in the food to decrease and a fire could result. Never leave microwave unattended while in use.



Shape

Uniform sizes heat more evenly. The thin end of a drumstick will cook more quickly than the meaty end. To compensate for irregular shapes, place thin parts toward the center of the dish and thick pieces toward the edge.



Size

Thin pieces cook more quickly than thick pieces.



Starting Temperature

Foods that are at room temperature take less time to cook than if they are chilled, refrigerated, or frozen.



Cooking Techniques

Piercing

Foods with skins or membranes must be pierced, scored or have a strip of skin peeled before cooking to allow steam to escape. Pierce clams, oysters, chicken livers, whole potatoes and whole vegetables. Whole apples or new potatoes should have a 1-inch strip of skin peeled before cooking. Score sausages and frankfurters. Do not Cook/Reheat whole eggs with or without the shell. Steam build up in whole eggs may cause them to explode, and possibly damage the oven or cause injury. Reheating SLICED hard-boiled eggs and cooking SCRAMBLED eggs is safe.



Browning

Foods will not have the same brown appearance as conventionally cooked foods or those foods which are cooked utilizing a browning feature. Meats and poultry may be coated with browning sauce, Worcestershire sauce, barbecue sauce or shake-on browning sauce. To use, combine browning sauce with melted butter or margarine and brush on before cooking. For quick breads or muffins, brown sugar can be used in the recipe in place of granulated sugar, or the surface can be sprinkled with dark spices before baking.



Spacing

Individual foods, such as baked potatoes, cupcakes and appetizers, will cook more evenly if placed in the oven equal distances apart. When possible, arrange foods in a circular pattern.





Cooking Techniques *(continued)*

Covering

As with conventional cooking, moisture evaporates during microwave cooking. Casserole lids or plastic wrap are used for a tighter seal. When using plastic wrap, vent the plastic wrap by folding back part of the plastic wrap from the edge of the dish to allow steam to escape. Loosen or remove plastic wrap as recipe directs for stand time. When removing plastic wrap covers, as well as any glass lids, be careful to remove them away from you to avoid steam burns. Various degrees of moisture retention are also obtained by using wax paper or paper towels.

Shielding

Thin areas of meat and poultry cook more quickly than meaty portions. To prevent overcooking, these thin areas can be shielded with strips of aluminum foil. Wooden toothpicks may be used to hold the foil in place.

▲CAUTION is to be exercised when using foil. Arcing can occur if foil is too close to oven wall or door and damage to your oven will result.

Cooking time

A range of cooking time is given in each recipe. The time range compensates for the uncontrollable differences in food shapes, starting temperature, and regional preferences. Always cook food for the minimum cooking time given in a recipe and check for doneness. If the food is undercooked, continue cooking. It is easier to add time to an undercooked product. Once the food is overcooked, nothing can be done.

Stirring

Stirring is usually necessary during microwave cooking. Always bring the cooked outside edges toward the center and the less cooked center portions toward the outside of the dish.

Rearranging

Rearrange small items such as chicken pieces, shrimp, hamburger patties or pork chops. Rearrange pieces from the edge to the center and pieces from the center to the edge of the dish.

Turning

It is not possible to stir some foods to distribute the heat evenly. At times, microwave energy will concentrate in one area of the food. To help insure even cooking, these food need to be turned. Turn over large foods, such as roasts or turkeys, halfway through cooking.

Stand Time

Most foods will continue to cook by conduction after the microwave oven is turned off. In meat cookery, the internal temperature will rise 5 °F to 15 °F (3 °C to 8 °C), if allowed to stand, tented with foil, for 10 to 15 minutes. Casseroles and vegetables need a shorter amount of standing time, but this standing time is necessary to allow foods to complete cooking to the center without overcooking on the edges.

Test for Doneness

The same tests for doneness used in conventional cooking may be used for microwave cooking. Meat is done when fork-tender or splits at fibers. Chicken is done when juices are clear yellow and drumstick moves freely. Fish is done when it flakes and is opaque. Cake is done when a toothpick or cake tester is inserted and comes out clean.

ABOUT FOOD SAFETY AND COOKING TEMPERATURE

Check foods to see that they are cooked to the United States Department of Agriculture's recommended temperatures.

TEMP	FOOD
160 °F	...for fresh pork, ground meat, boneless white poultry, fish, seafood, egg dishes and frozen prepared food.
165 °F	...for leftover, ready-to-reheat refrigerated, and deli and carryout "fresh" food.
170 °F	...white meat of poultry.
180 °F	...dark meat of poultry.

To test for doneness, insert a meat thermometer in a thick or dense area away from fat or bone. NEVER leave the thermometer in the food during cooking, unless it is approved for microwave oven use.



Care and Cleaning of Your Microwave Oven

BEFORE CLEANING:

Unplug oven at wall outlet. If outlet is inaccessible, leave oven door open while cleaning.

AFTER CLEANING:

Be sure to place the Roller Ring and the Glass Tray in the proper position and press **Stop/Reset Pad** to clear the Display.

Label:

Do not remove, wipe with a damp cloth.

Inside of the oven:

Wipe with a damp cloth after using. Mild detergent may be used if needed. Do not use harsh detergents or abrasives.

Oven Door:

Wipe with a soft dry cloth when steam accumulates inside or around the outside of the oven door. During cooking, especially under high humidity conditions, steam is given off from the food. (Some steam will condense on cooler surfaces, such as the oven door. This is normal.) Inside surface is covered with a heat and vapor barrier film. **Do not remove.**

Roller Ring and oven cavity floor:

Clean the bottom surface of the oven with mild detergent water or window cleaner, and dry. Roller Ring may be washed in mild soapy water or dishwasher. These areas should be kept clean to avoid excessive noise.

Glass Tray:

Remove and wash in warm soapy water or in a dishwasher.

Outside oven surfaces:

Clean with a damp cloth. To prevent damage to the operating parts inside the oven, water should not be allowed to seep into ventilation openings.

Control Panel:

- * Covered with a removable protective film to prevent scratches during shipping. Small bubbles may appear under this film. (*Hint - To remove film, apply masking or clear tape to an exposed corner and pull gently.*)
- * If the Control Panel becomes wet, clean it with a soft dry cloth. Do not use harsh detergents or abrasives.

Do not remove wave guide cover: It is important to keep cover clean in the same manner as the inside of the oven.

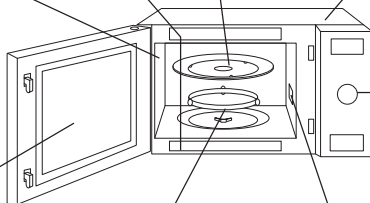

IT IS IMPORTANT TO KEEP THE OVEN CLEAN AND DRY. FOOD RESIDUE AND CONDENSATION MAY CAUSE RUSTING OR ARCING AND DAMAGE TO THE OVEN. AFTER USE, WIPE DRY ALL SURFACES-INCLUDING VENT OPENINGS, OVEN SEAMS, AND UNDER GLASS TRAY.

PARTS DESCRIPTION

PART NUMBER

Instructions / Operating Manual (this book)

F003BP00AP

Glass Tray

A06014M00AP (NN-SD975S)

A06014A00AP (NN-SD775S)

Roller Ring Assembly

F290D9R00AP (NN-SD975S)

F290DBP20AP (NN-SD775S)

Accessory Purchases (United States and Puerto Rico)

Purchase Parts, Accessories and Owner's Manual online for all Panasonic Products by visiting our Web Site at: <http://www.pstc.panasonic.com>

Or, send your request by E-mail to: npcparts@us.panasonic.com

You may also contact us directly at:

1-800-332-5368 (Phone) 1-800-237-9080 (Fax Only) (Monday-Friday 9am-9pm EST)

Panasonic National Parts Center

20421 84th Avenue South

Kent, WA 98032

(We accept Visa, MasterCard, Discover Card, American Express)

For hearing or speech impaired TTY users, TTY: 1-866-605-1277



Before Requesting Service

These things are normal:

The oven causes interference with my TV.

Some radio, TV, Wi-Fi, cordless telephone, baby monitor, blue tooth or other wireless equipment interference might occur when you cook with the microwave oven. This interference is similar to the interference caused by small appliances such as mixers, vacuums, blow dryers, etc. It does not indicate a problem with your oven.

Steam accumulates on the oven door and warm air comes from the oven vents.

During cooking, steam and warm air are given off from the food. Most of the steam and warm air are removed from the oven by the air which circulates in the oven cavity. However, some steam will condense on cooler surfaces such as the oven door. This is normal. After use, the oven should be wiped dry (see page 28).

PROBLEM

POSSIBLE CAUSE

REMEDY

Oven will not turn on.

The oven is not plugged in securely.

Remove plug from outlet, wait 10 seconds and re-insert.

Main circuit breaker or main fuse is tripped or blown.

Reset main circuit breaker or replace main fuse.

There is a problem with the outlet.

Plug another appliance into the outlet to check if it is working.

Oven will not start cooking.

The door is not closed completely.

Close the oven door securely.

Start Button was not pressed after programming.

Press **Start** Button.

Another program is already entered into the oven.

Press **Stop/Reset** Button to cancel the previous program and enter new program.

The program is not correct.

Program again according to the Operating Instructions.

Stop/Reset Button has been pressed accidentally.

Program oven again.

The Glass Tray wobbles.

The Glass Tray is not positioned properly on the Roller Ring or there is food under the Roller Ring.

Take out Glass Tray and Roller Ring. Wipe with a damp cloth and reset Roller Ring and Glass Tray properly.

When the oven is operating, there is noise coming from the glass tray.

The Roller Ring and oven bottom are dirty.

Clean these parts according to **Care and Cleaning of your Microwave oven** (see page 28).

The word "LOCK" appears in the Display Window.

The CHILD LOCK was activated.

Deactivate LOCK by pressing **Stop/Reset** Button 3 times.

The oven stops cooking and "H00", "H97" or "H98" appears in the display window.

This displaying indicates a problem with the microwave generation system.

Please contact an authorised Service Center (see page 30).

The word "DEMO MODE" appears in the display Window.

Demo mode was selected "On".

Deactivate mode by pressing Power Level key once Start Key 4 times and Stop/Reset Key 4 times.

Limited Warranty (Only for U.S.A.)

Panasonic Products Limited Warranty

Limited Warranty Coverage (For USA Only)

If your product does not work properly because of a defect in materials or workmanship, Panasonic Consumer Electronics Corporation (referred to as "the warrantor") will, for the length of the period indicated on the chart below, which starts with the date of original purchase ("warranty period"), at its option either (a) repair your product with new or refurbished parts, (b) replace it with a new or a refurbished equivalent value product, or (c) refund your purchase price. The decision to repair, replace or refund will be made by the warrantor.

Product or Part Name	Labor	Parts
ALL PARTS (EXCEPT MAGNETRON TUBE)	1 yr.	1 yr.
MAGNETRON TUBE	1 yr.	5 yr.

During the "Labor" warranty period there will be no charge for labor. During the "Parts" warranty period, there will be no charge for parts.

This warranty only applies to products purchased and serviced in the United States. This warranty is extended only to the original purchaser of a new product which was not sold "as is".

Carry-In or Mail in Service:

To find a service center please visit:
<http://www.panasonic.com/support>

When shipping the unit, carefully pack and send it in the original (or supplied) carton. Include a letter detailing the complaint along with the bill of sales and provide a daytime phone number where you can be reached. A valid registered receipt is required under the Limited Warranty.

When shipping Lithium Ion batteries please visit our web site at www.panasonic.com/BatteryHandling as Panasonic is committed to providing the most up to date information.

IF REPAIR IS NEEDED DURING THE WARRANTY PERIOD, THE PURCHASER WILL BE REQUIRED TO FURNISH A SALES RECEIPT/PROOF OF PURCHASE INDICATING DATE OF PURCHASE, AMOUNT PAID AND PLACE OF PURCHASE. CUSTOMER WILL BE CHARGED FOR THE REPAIR OF ANY UNIT RECEIVED WITHOUT SUCH PROOF OF PURCHASE.

Limited Warranty Limits And Exclusions

This warranty ONLY COVERS failures due to defects in materials or workmanship, and DOES NOT COVER glass, plastic parts, temperature probes (if included) and normal wear and tear or cosmetic damage. The warranty ALSO DOES NOT COVER damages which occurred in shipment, or failures which are caused by products not supplied by the warrantor, or failures which result from accidents, misuse, abuse, neglect, bug infestation, mishandling, misapplication, alteration, faulty installation, set-up adjustments, maladjustment of consumer controls, improper maintenance, power line surge, lightning damage, modification, or commercial use (such as in a hotel, office, restaurant, or other business), rental use of the product, service by anyone other than a Factory Service center or other Authorized Servicer, or damage that is attributable to acts of God.

THERE ARE NO EXPRESS WARRANTIES EXCEPT AS LISTED UNDER "LIMITED WARRANTY COVERAGE".

THE WARRANTOR IS NOT LIABLE FOR INCIDENTAL OR CONSEQUENTIAL DAMAGES RESULTING FROM THE USE OF THIS PRODUCT, OR ARISING OUT OF ANY BREACH OF THIS WARRANTY.

(As examples, this excludes damages for lost time, travel to and from the servicer, loss of or damage to media or images, data or other memory or recorded content. The items listed are not exclusive, but for illustration only.)

ALL EXPRESS AND IMPLIED WARRANTIES, INCLUDING THE WARRANTY OF MERCHANTABILITY, ARE LIMITED TO THE PERIOD OF THE LIMITED WARRANTY.

Some states do not allow the exclusion or limitation of incidental or consequential damages, or limitations on how long an implied warranty lasts, so the exclusions may not apply to you.

This warranty gives you specific legal rights and you may also have other rights which vary from state to state. If a problem with this product develops during or after the warranty period, you may contact your dealer or ServiceCenter. If the problem is not handled to your satisfaction, then write to:

Consumer Affairs Department
Panasonic Corporation of North America
661 Independence Pkwy
Chesapeake, VA23320

PARTS AND SERVICE, WHICH ARE NOT COVERED BY THIS LIMITED WARRANTY, ARE YOUR RESPONSIBILITY.

Shop Accessories!

for all your Panasonic gear
Go to

www.panasonic.com/accessories

Get everything you need to get the most out of your Panasonic products

Accessories & Parts for your Camera, Phone, A/V products, TV, Computers & Networking, Personal Care, Home Appliances, Headphones, Batteries, Backup Chargers & more...

































Customer Services

Directory























For Product Information, Operating Assistance, Parts, Owner's Manuals, Dealer and Service info go to
www.panasonic.com/support
For the hearing or speech impaired

TTY: 1-877-833-8855

Quick Guide to Operation

Feature	How to Operate		
To set Clock (☛page 11)	Timer/Clock  Press twice.	 Time Dial To set time of day.	Timer/Clock  Press once.
To Use Child Safety Lock (☛page 11)	To Set:  Start  Press 3 times.	To Cancel:  Stop/Reset  Press 3 times.	
To Use Power and Time (☛page 14)	Power Level (10 Levels)  Press to select Power Level.	 Time Dial Set time.	 Start  Press once.
To use Keep Warm (☛page 15)	Keep Warm  Press once.	 Time Dial Set time. (up to 30 min.)	 Start  Press once.
To cook using Quick 30 (☛page 15)	To Set Time: Power Level (10 Levels)  Press to select Power Level.	Quick 30  Set time. (up to 5 min.)	 Start  Press once.
	To Add Time: During manual cooking.		Quick 30  Press to add time. (up to 5 min.)
To cook using Coffee/Milk (☛page 15)	Coffee/Milk  Press to select the desired menu.	More/Less  Optional.	 Start  Press once.
To cook using Popcorn (☛page 16)	Popcorn (3 Levels)  Press to select weight.	More/Less  Optional.	 Start  Press once.
To defrost using Inverter Turbo Defrost (☛page 17)	Inv.Turbo Defrost (lb/kg)  Press once.	 Weight Dial Set weight.	 Start  Press once.

Quick Guide to Operation *(continued)*

Feature	How to Operate			
To reheat using Sensor Reheat (☛page 19)	Sensor Cook/ Reheat (1-20)  Press once.	 Sensor Menu Dial Select the sensor reheat.	More/ Less  Optional.	 Start  Press once.
To reheat using Sensor Cook (☛page 19)	Sensor Cook/ Reheat (1-20)  Press once.	 Sensor Menu Dial Select the desired sensor menu.	More/ Less  Optional.	 Start  Press once.
To use as a Kitchen Timer (☛page 23)	Timer/ Clock  Press once.	 Time Dial Set time.	 Start  Press once.	
To set Stand Time (☛page 23)	(Input up to 2-stage cook- ing programs.)  Press once.	 Time Dial To set time.	 Start  Press once.	
To Use Delay Time (☛page 23)	Timer/ Clock  Press once.	 Time Dial To set time.	(Input up to 2-stage cook- ing programs.) 	 Start  Press once.



Specifications

	NN-SD975S	NN-SD775S
Power Source:	120 V 60 Hz	
Power Consumption:	12.3 A 1,460 W	
Cooking Power:*	1,250 W	
Outside Dimensions (W x H x D):	23 7/8" x 14" x 19 15/16" (606 mm x 356 mm x 506 mm)	21 7/8" x 11 15/16" x 19 15/16" (555 mm x 304 mm x 506 mm)
Oven Cavity Dimensions (W x H x D):	17 11/16" x 10 13/16" x 18 1/2" (449 mm x 274 mm x 470 mm)	15 11/16" x 8 1/4" x 18 1/2" (398 mm x 210 mm x 470 mm)
Operating Frequency:	2,450 MHz	
Net Weight:	Approx. 36.8 lbs. (16.7 kg)	Approx. 31.5 lbs. (14.3 kg)

Trim Kit for 27" Cabinet:

	NN-SD975S	NN-SD775S
Model Number:	NN-TK922S	NN-TK722S
Outside Dimensions (W x H):	27" x 18 9/16" (684 mm x 472 mm)	27" x 16 1/2" (684 mm x 419 mm)
Cabinet Opening (W x H x D):	25 1/2" x 17 3/8" x 21" (648 mm x 442 mm x 533 mm)	25 1/2" x 15 5/16" x 21" (648 mm x 389 mm x 533 mm)

Trim Kit for 30" Cabinet:

	NN-SD975S	NN-SD775S
Model Number:	NN-TK932S	NN-TK732S
Outside Dimensions (W x H):	30" x 18 9/16" (760 mm x 472 mm)	30" x 16 1/2" (760 mm x 419 mm)
Cabinet Opening (W x H x D):	28 1/2" x 17 3/8" x 21" (724 mm x 442 mm x 533 mm)	28 1/2" x 15 5/16" x 21" (724 mm x 389 mm x 533 mm)

*IEC Test procedure

Specifications subject to change without notice.

User's Record

The serial number of this product may be found on the back side of the oven or on the left side of the control panel. You should note the model number and the serial number of this oven in the space provided and retain this book as a permanent record of your purchase for future reference.

Model No. _____

Serial No. _____

Date of Purchase _____

Panasonic Corporation of North America
Two Riverfront Plaza, Newark, NJ 07102-5490

Panasonic Appliances Microwave Oven (Shanghai) Co., Ltd.