

Thank you for choosing Sunnydaze Decor. We stand behind our brand and the quality of the items we sell. Replacement parts or products will be sent at our discretion within the 1-year warranty period. Proof of purchase, with the date of purchase as well as photos of the merchandise defect, must be provided. Photos are used to determine the cause of defects and for future quality control. Register your warranty at <https://tiny.cc/SunnydazeWarranty>. If you have any questions, comments or concerns, feel free to contact us by phone at 833-982-1977, by email: [customerservice@sunnydazedecor.com](mailto:customerservice@sunnydazedecor.com), or via our contact us page at <https://tiny.cc/SunnydazeContact>

# QUILTED FABRIC HAMMOCK WITH UNIVERSAL HAMMOCK STAND

Read all assembly and care instructions carefully before using this product. Save these instructions for future reference.





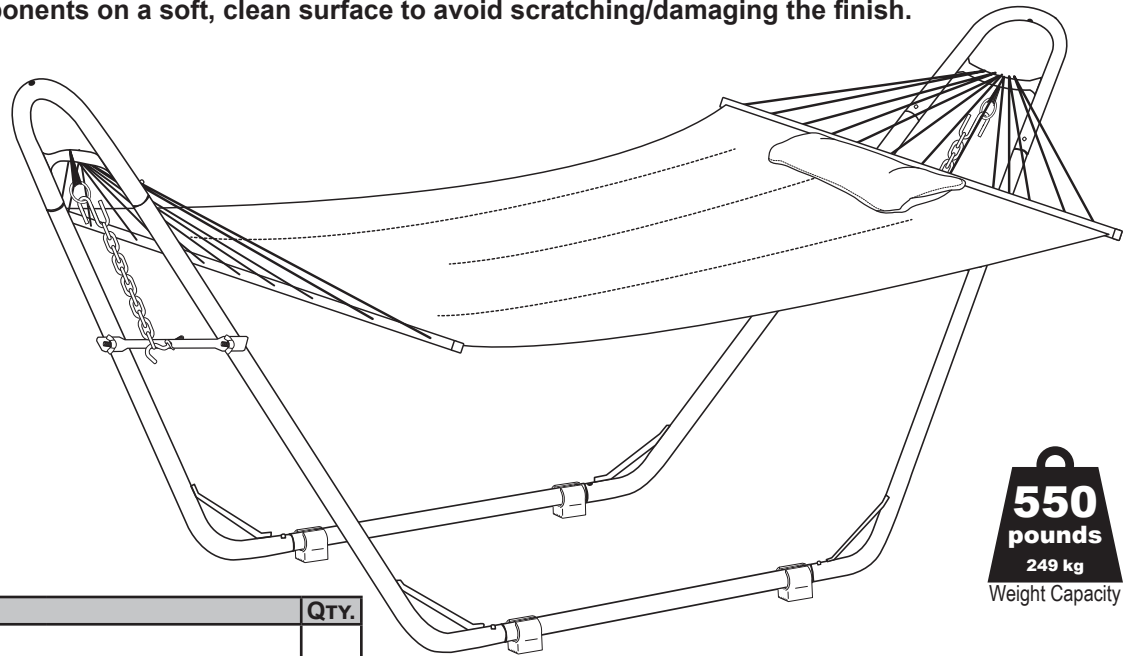



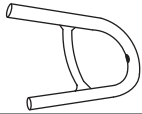

Select a smooth, level surface to place the hammock stand.

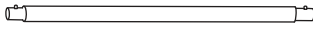
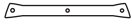
Assemble components on a soft, clean surface to avoid scratching/damaging the finish.

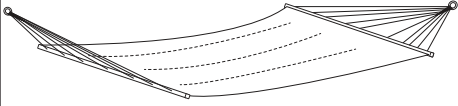

Inspect packaging to ensure all parts are accounted for before disposing of packing materials.

**550**  
pounds  
249 kg  
Weight Capacity

PARTS		QTY.
	Top Frame	2
	Curved Bar	4
	Base Bar	2
	Support Crossbar	2
	Plastic Foot	4
	M8 x 60mm Bolt Set	4
	M8 Hook Bolt Set	2
	S-Hook	2
	Chain	2
	Hammock	1
	Hammock Pillow	1

## ⚠ CAUTION ⚠

*This hammock and stand are not designed for use as a swing. Bouncing, swinging, or any other significant movement while in use may result in serious injury.*

*This stand must be used on a level, stable surface. Make sure all connection points are fully and securely engaged before every use.*

## ⚠ WARNING

**CHOKING HAZARD** — This item contains small parts that can be swallowed. Keep children away during assembly.

**⚠ WARNING:** Failure to read and follow instructions and safety warnings could result in serious injury or damage to property.

# ASSEMBLY

**!** Carefully read all assembly steps, care instructions, and safety information before using this product. **!**

Save these instructions for future reference.

Assemble components on a soft, clean surface to avoid scratching/damaging the finish.

When choosing a location for your hammock stand, select a smooth, level surface.

**Do not install on dangerous terrain or objects such as slopes, on rocks, or in bodies of water.**

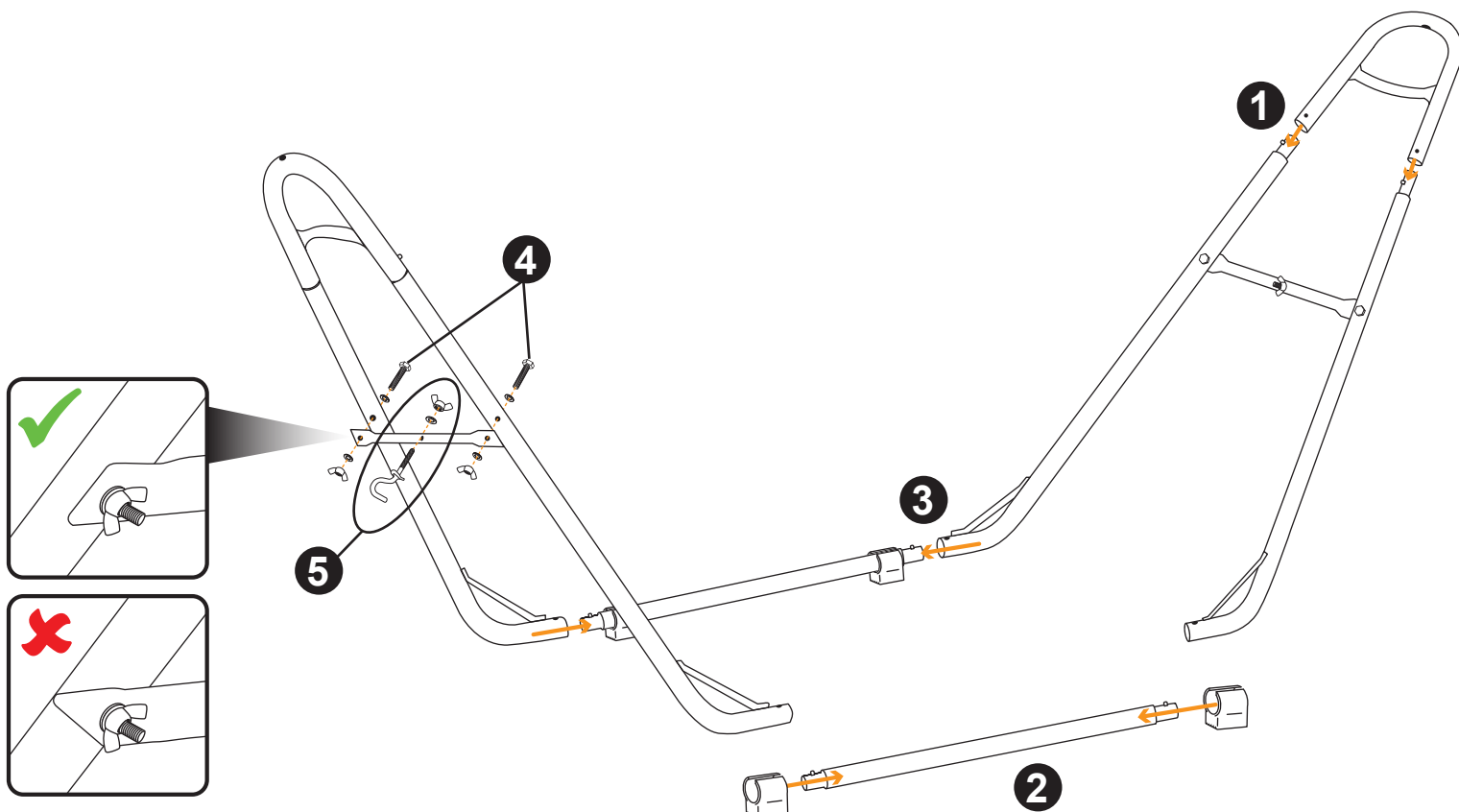

**After completing each step, repeat the step for the opposite side of the hammock stand.**

1. Connect the Top Frame to the Curved Bars, as shown.
2. Next, slide two Plastic Feet onto the Base Bar.
3. Connect the Base Bars to the Curved Bars.
4. Paying close attention to the shape and direction of the Support Crossbar, connect the crossbar to the Diagonal Bars using two M8 x 60mm Bolt Sets. Install bolts with the wingnut on the outside.
5. Ensuring the hook is facing downward, firmly secure the Hook Bolt to the outside of the Crossbar, as shown.

## **!** WARNING:

Manufacturer and seller expressly disclaim any and all liability from personal injury, property damage or loss, whether direct or indirect, or incidental, resulting from the incorrect attachment, improper use, inadequate maintenance, or neglect of this product.

# HANGING YOUR HAMMOCK

**! IMPORTANT:** To prevent tipping, always leave slack in the fabric when hanging hammocks. Adjust hammock height so the user can get in and out of the hammock safely.

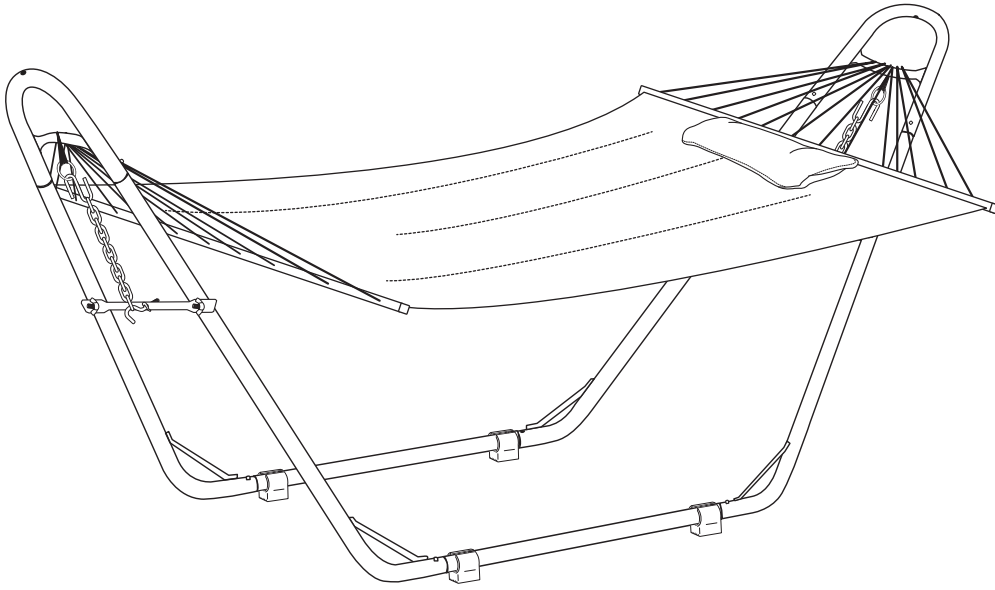

Lay the ropes of the hammock over the top frame crossbars, as shown. Use the S-hooks and chains to hang the hammock on the hook bolt.

Adjust the length of the chains to tighten/loosen the fit of the hammock. Always leave some slack in the fabric when hanging your hammock to prevent tipping. The center of the hammock fabric should be at a height where the user can enter and exit the hammock safely, but also high enough that it will not touch the ground after weight is in the hammock. Taut = tipsy!

## HOW TO RELAX IN YOUR HAMMOCK

**! WARNING:** Failure to read and follow instructions and safety warnings could result in serious injury.

**! BEFORE USE:** Carefully read all use, care, and safety information to ensure this product is used safely.



Take your time getting into and out of your hammock; any hammock can tip when weight is not centered.



**1** With your backside toward the hammock, hold the edge with both hands and slowly sit in the hammock, ensuring both feet remain firmly on the ground.



**2** Once seated and stabilized, continue to firmly hold the edge of the hammock and carefully scoot yourself backward, toward the center of the hammock.



**3** Release one hand and firmly grip the opposite side of the hammock.

Lift one leg into the hammock, then the other.

*If the hammock begins to tip, position your feet back on the ground and start again.*



**4** Once you have found a comfortable position, release the sides of the hammock and relax.

# GENERAL USE & CARE

**SAFE USE:** Follow all safety statements and warnings (page 5).

Never exceed the weight capacity of the hammock stand, 550 lbs.

Take your time getting in and out of the hammock. Any hammock may tip if your weight is not centered.

Swinging, bouncing, jumping, or any other excessive movement may result in serious injury, including, but not limited to, the stand tipping over or dislodging the spring buttons causing components to disconnect.

**CHILDREN:** This product is only to be used by adults and person(s) with developed motor skills who also understand the potential dangers if misused. Supervise children at all times. Never allow small or young children to enter or exit a hammock without adult assistance. Never allow or encourage children to sleep or play in a hammock. Always teach and practice safe hammock use, with and without a hammock stand. Always teach and practice safe hammock use.

**SUN EXPOSURE:** All fabrics will eventually fade and degrade from sun exposure. The less direct sunlight the hammock is exposed to, the longer the life of fabric and ropes will be.

**STORAGE:** Store indoors when not in use; do not leave outdoors during winter or while raining. Cool, dry locations are recommended to prevent damage that may result from exposure to moisture.

If the stand is left outdoors during summer months, cover it to prevent damages caused by water and sunlight.

**INSPECTION:** Examine the stand before each use to ensure it is assembled correctly, and all connection points are secure. Frequently inspect the ropes, fabric, and spreader bar for wear and weakness.

**SCRATCHES:** The powder coating on the stand is tough and durable, but even under normal use, some scratching is inevitable. To prevent excessive rust, wipe scratched areas to remove moisture.

## CLEANING



SPOT CLEAN/HAND-WASH ONLY



DO NOT USE BLEACH OR FABRIC SOFTENERS



LAY HAMMOCK FLAT TO DRY



DO NOT IRON HAMMOCK OR PILLOW

### HAMMOCK & PILLOW

Vacuum or gently brush dirt and debris off the fabric.

Spot clean with a damp cloth.

For more stubborn stains, hand-wash the fabric in a bathtub or kiddie pool using mild soap and a soft-bristled scrub brush. Soaking may be required for heavily soiled fabrics. Keep the wooden spreader bars, galvanized O-rings and chains out of the water as much as possible.

Thoroughly rinse all soap residue—air-dry on a flat surface to prevent the ropes from stretching. Expedite drying time by pressing the quilted fabric between dry towel. The ropes may shrink slightly while drying but will stretch back out with use.

To dry the pillow, press it between dry towels. Hang or prop it against a wall and allow it to thoroughly air dry.

### HAMMOCK STAND

Use a soft cloth and warm water to wipe down the stand. Wipe away moisture with a soft, clean cloth.

Avoid exposing the inside of the hammock frame to water as doing so will cause the exposed metal inside the frame to rust.

## ! SAFETY STATEMENTS & WARNINGS !

This hammock and stand are only to be used by adults and person(s) with developed motor skills who understand the potential dangers if they are misused.

Supervise children at all times. Never allow small or young children to enter or exit a hammock without adult assistance. Never allow or encourage children to sleep or play in a hammock. Always teach and practice safe hammock use.



**Take your time getting into and out of your hammock; any hammock can tip when weight is not centered.**

To prolong the lifespan of your Sunnydaze hammock, we recommend that you always bring the hammock inside when not in use, as the sun, rain, and other outdoor elements will deteriorate the materials over time. If using near bodies of salt water, it is important to rinse the hammock regularly. In addition, ensure the hammock is dry when storing to prevent mold and mildew.



**WARNING:** Do not use if parts are missing, worn, or damaged.



**WARNING:** Never leave a hammock hanging when not in use.



**WARNING:** Do not allow children to use this product without constant adult supervision.



**WARNING:** Always keep weight centered when entering and exiting the hammock.

- **DO NOT** exceed the recommended weight capacity.
- **DO NOT** enter the hammock feet first.
- **DO NOT** dive into or jump in the hammock.
- **DO NOT** stick your head or any other body part through the ropes.
- **DO NOT** pull yourself up or reposition yourself by the spreader bar.
- Keep hanging ropes as straight as possible, do not twist or knot. Never untie the ropes.
- **Hammocks are not designed for swinging.** Excessive swinging and other rough play may result in injuries and will wear out your hammock and stand prematurely.
- **DO NOT** leave children unattended in hammocks or near hammocks.
- Pets should not be allowed into hammocks as it may result in injuries or damage to the product.
- Hammock fabrics and accessories will become worn over time and use, do not use the hammock if fabric is torn, ropes are frayed or the spreader bar is cracked.
- If possible, use this product over a surface with shock-absorbing properties such as carpet or grass. Doing so helps minimize the risk of injury if occupant(s) fall out of the hammock.
- **ALWAYS** store the hammock indoors when not in use. Cover or store the stand when not in use.
- **DO NOT** leave the hammock on the stand when not in use. Uplift from wind will cause stand to tip over and may damage the hammock and the stand.

### ! WARNING:

**Manufacturer and seller expressly disclaim any and all liability from personal injury, property damage or loss, whether direct or indirect, or incidental, resulting from the incorrect attachment, improper use, inadequate maintenance, or neglect of this product.**

# TROUBLESHOOTING

If you are unfamiliar with using a hammock, it can leave you feeling uneasy; take some time to get used to it. Always enter and exit your hammock slowly. Swinging or aggressive movement can easily make the hammock or stand tip over and/or cause the metal to bend.

## THE STAND SEEMS UNSTABLE

- Ensure all components are assembled correctly and the snap buttons are fully engaged within the mounting holes.
- Make sure the stand is on a flat, level surface.
- Due to the design of the stand, there will always be some 'give' at the assembly points; this is normal. Ensure occupant(s) are entering the hammock safely. Entering the hammock and adjusting position slowly is necessary for safe use of this product.

## MY HAMMOCK HANGS TOO LOW TO THE GROUND OR IS TOO HIGH TO ENTER SAFELY

- Adjust the distance of between the chains and the hooks on the hammock stand.
- Always leave some slack in the hammock fabric. Taut = tipsy!

## I HAVE OTHER QUESTIONS OR CONCERNS

Contact Sunnydaze Decor customer service team directly through one of the methods mentioned at the top of page 1. To expedite response time, please have the item number and order information available.

**Any modification to the product or failure to follow recommended care will void the product warranty.**



## LEARN MORE ABOUT HAMMOCK SAFETY!

SCAN THE CODE WITH YOUR SMARTPHONE  
OR VISIT

<https://tiny.cc/hammock-safety>

## WARNING:

Manufacturer and seller expressly disclaim any and all liability from personal injury, property damage or loss, whether direct or indirect, or incidental, resulting from the incorrect attachment, improper use, inadequate maintenance, or neglect of this product.