

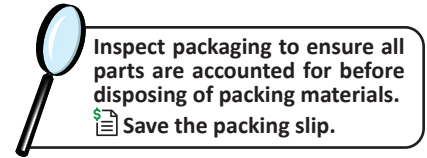





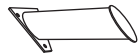
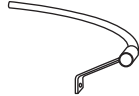

COSMIC SMOKELESS FIRE PIT

NB-984

Review all assembly and care information before using this product. Save this manual for future reference.
Assemble components on a soft, clean surface to avoid damaging the finish.



No.	PARTS	QTY.
A	 Smokeless Fire-Bowl	1
B	 Leg	3
C	 Safety Ring	4
D	 Heat Deflector	1
E	 Ash Tray	1
F	 Poker	1
G	 Cover	1
1	 M6x8mm Bolt	4
2	 M6x12mm Bolt	16

⚠ WARNING ⚠
CHOKING HAZARD — This item contains small parts that can be swallowed. Keep children and pets away during assembly.

TOOLS REQUIRED (not included)	
	✗ Phillips Screwdriver

⚠ WARNING:
 Manufacturer and seller expressly disclaim any and all liability from personal injury, property damage or loss, whether direct or indirect, or incidental, resulting from the incorrect attachment, improper use, inadequate maintenance, or neglect of this product.

ASSEMBLY

STEP 1

A: 1
E: 1
2: 3

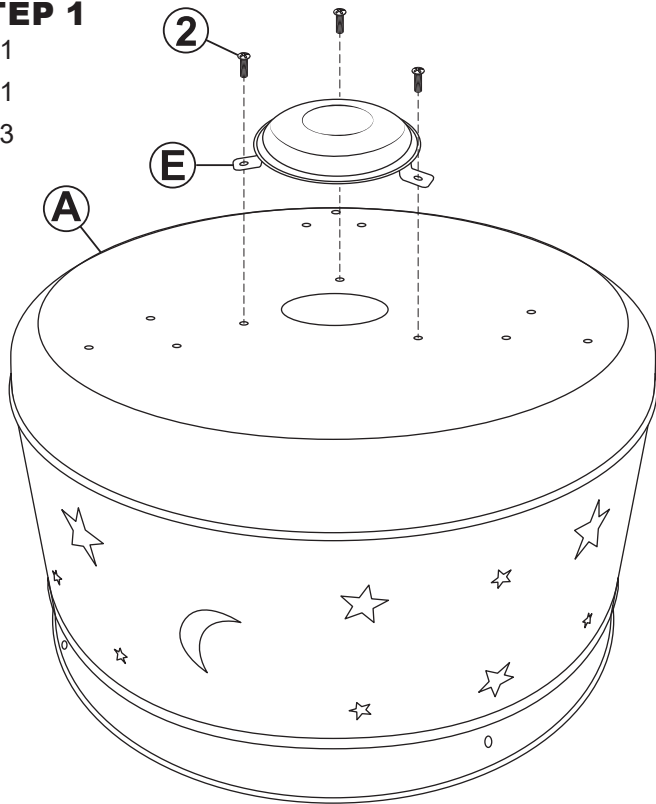

Securely fasten Ash Tray (E) to the bottom of Smokeless Fire-Bowl (A) using three M6x12mm Bolts (2).

STEP 2

B: 3
2: 9

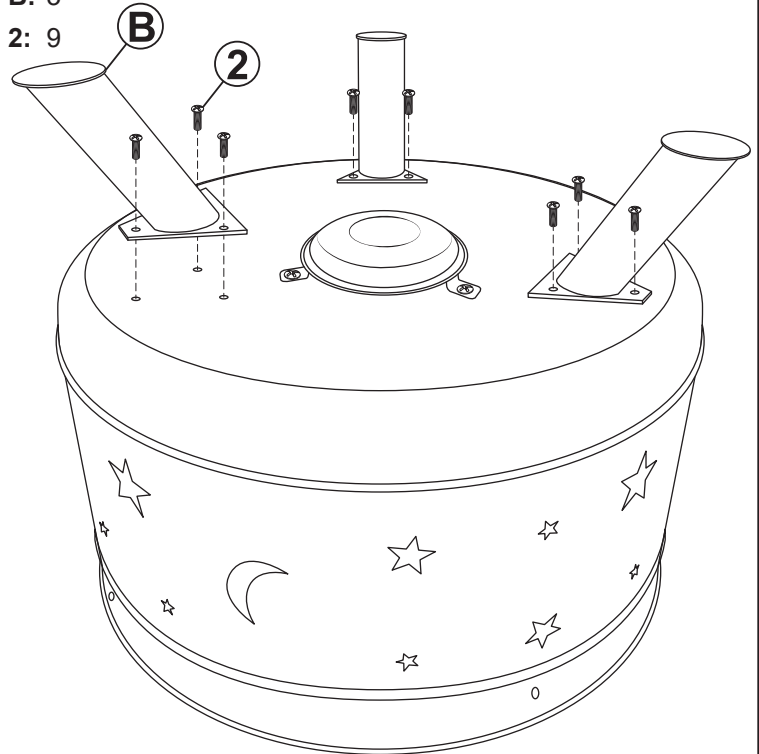

Align one Leg (B) with the bottom of the fire-bowl and securely fasten using three M6x12mm Bolts (2).

Repeat to fasten the remaining two legs.

STEP 3

C: 4
2: 4
1: 4

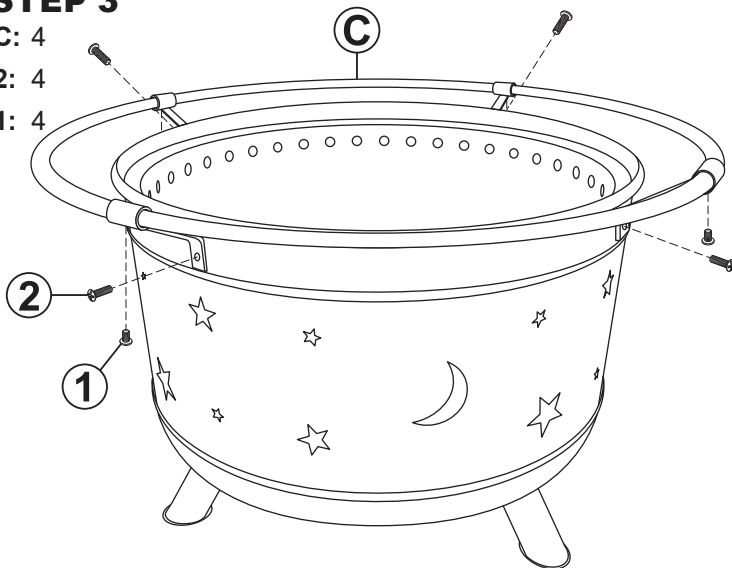

Insert one Safety Rings (C) into another and loosely secure them by hand-tighten the rings to the fire-bowl using M6x12mm Bolts (2). Then, loosely connect the remaining two rings to the fire-bowl.

Ensuring the ring is straight, use four M6x6mm Bolts (1) to secure the rings to each other.

Finish tightening all bolts.

STEP 4

D: 1

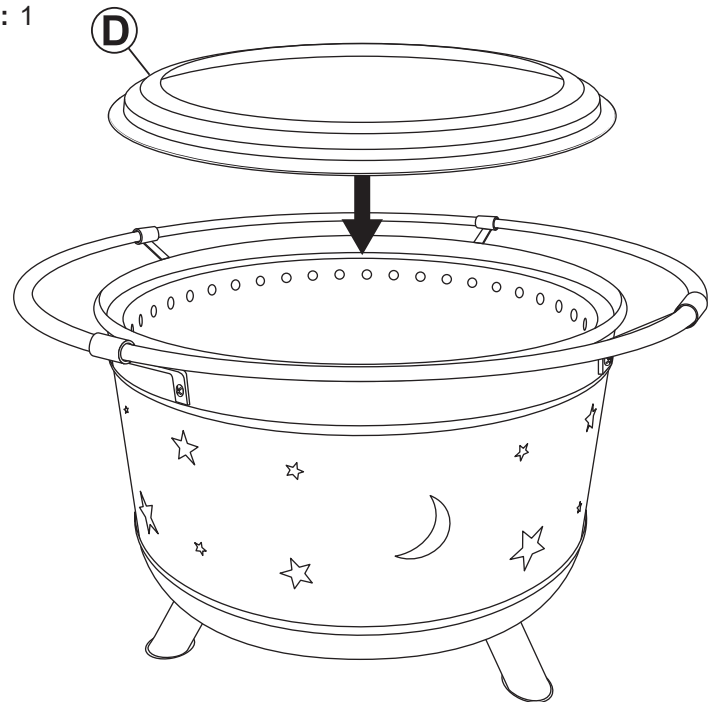

Place Heat Deflector (D) onto the fire-bowl.

OPERATION

Prepare:

1. Only use seasoned/dry wood; wet wood increases smoke and burns less efficiently.
2. Clean out all ash and debris before every use. Leaving ash and debris in the fire pit reduces airflow and can prevent secondary combustion.

Lighting:

1. Place dry wood that is no longer than 3/4 the depth of the fire pit, into the center of the fire pit. Wood should remain below the top row of air holes inside the fire pit. Do not let wood rest on the flame rim.
TIP: Start small, use smaller wood pieces for starting the fire. Add larger pieces after the fire is going strong.
2. Add tinder and dry kindling to the base of the wood stack.
3. Use a long match to light the tinder/kindling.
4. Allow several minutes for the wood to catch fire.

NOTE: There may be smoke when the fire is first lit, and as the fire begins to spread.

As the wood catches fire, and the walls of the fire pit begin to warm up, secondary combustion will create a smokeless fire.

Tending:

1. Protective gloves and long-handled tools are recommended for use with this fire pit.
2. Use a fire poker or fire tongs to shift burning wood and embers to allow for additional airflow.
3. Wait until the fire is going strong before adding additional wood. While adding wood, take care not to smother the fire, leave plenty of room for oxygen between the logs.

Extinguishing:

1. It is best to allow the fire to burn out by itself.
2. Do not use water to put out a fire, the sudden temperature drop will damage to the fire pit.
3. Once the fire pit has completely extinguished and cooled down, clean out and properly dispose of all ashes and debris.
4. When not in use, store this unit in a dry location.

CARE & MAINTENANCE

SAFE USE: Always use fire pits on a flat, non-combustible surface such as concrete, rock, or stone. Do not use this fire pit on a wood deck or any other combustible surfaces like dry grass, leaves, mulch, etc. Never use in an area with an overhead structure or near unprotected combustible constructions like vinyl or wood siding. Avoid using near or under overhanging trees and shrubs.

The fire pit will become extremely hot while in use. Always use the fire-resistant gloves and long-handled tools while maintaining a fire.

NO ACCELERANTS, NO PLASTIC: Never use accelerants to start a fire; this is dangerous and can damage the fire pit.

Never use any plastic materials in or nearby a fire pit. The emissions from burning plastic are toxic. Additionally, plastic residue is very difficult to remove and could plug the airflow holes.

EXTINGUISH: Let fires gradually die down and go out on their own. DO NOT use water to put out a fire as the sudden drop in temperature may damage the metal and/or cause serious injury.

Note, ashes can remain hot long after a fire dies down. If you feel heat when your hand is close to the metal or the ashes, the unit is too hot to safely empty.

EXPOSURE & MAINTENANCE: Long-term exposure to high-intensity heat can cause the high-temperature paint to flake or burn off the steel. If the paint burns off, and the steel is exposed to moisture, it will rust. As with any outdoor steel product, periodic maintenance is required to maintain integrity and appearance. Remove rust and refinish with a suitable high-temperature paint (not included); carefully follow the manufacturer instructions and ensure the paint is completely dry before using the unit again.

Do not allow ash to accumulate in the bottom of the pit; ash can plug the airflow holes. Never drop the fire pit as doing so could cause permanent damage.

CLEANING: Ensure the fire pit and ashes are completely cool before cleaning. Ashes can remain hot long after a fire dies down. If you feel heat when your hand is close to the metal or the ashes, the fire pit is too hot to clean.

Remove ashes and debris from the ash tray and the inside of the fire pit before every use.

COVER AND STORE: Ensure the fire pit is completely cool before covering. Always clean the fire pit before covering it. Do not allow the fire pit to be exposed to water. Manufacturer is not liable for damage resulting from general use and/or environmental conditions. Store in a dry location to protect it from the effects of weather elements.

SAFETY STATEMENTS & WARNINGS

- For outdoor use only. Never use this product in an enclosed area.
- Always follow local laws and regulations when using wood-burning fire pits.
- Exercise the same care and precautions as you would with an open fire.
- Keep unit a safe distance away from buildings, balconies, or overhangs when in use.
- Only use this fire pit on a level, non-combustible surface.
- Do not use on or near combustible surfaces or structures such as wood decks, dry leaves or grass, mulch, vinyl or wood siding, etc.
- Keep away from all combustible materials, including gasoline and other flammable liquids and vapors.
- Never use accelerants such as, but not limited to, gasoline, alcohol, paint thinners, kerosene, as this may cause serious injury and product damage.
- The fire pit becomes very hot when in use. Ensure the unit completely cool before cleaning or moving.
- Always supervise children and pets when the fire pit is in use.
- Do not overfill or use this unit to burn leaves or trash.
- Avoid using any fire pit during dry or windy conditions.
- Never leave unit unattended while hot or in use.
- DO NOT USE CHEMICAL-BASED CLEANERS as this may damage the product and/or ignite a flame during the next use.
- Extinguish the fire properly before leaving the unit unattended. It is best to let the fire die on its own, but you can use a bucket of sand to smother the fire if necessary. Do not use water to extinguish hot fires or embers as this may cause serious injury and damage the product.
- Ashes can remain hot for a long time after fire is extinguished. Dispose of cold ashes properly.
- Ensure the unit is completely cool before moving or covering.

Contact your local authorities regarding possible burn restrictions before using this product.

Any modification to the product or failure to follow recommended care will void the product warranty.

If you experience issues with assembly or the product was damaged during shipping, please contact our customer service team through one of the methods mentioned at the top of page 1.

Please have the item number and your order information ready to expedite response time.

WARNING!

Manufacturer and seller expressly disclaim any and all liability from personal injury, property damage or loss, whether direct or indirect, or incidental, resulting from the incorrect attachment, improper use, inadequate maintenance, or neglect of this product.