

CIMUKA EGG INCUBATORS HB175 / HB350 / HB500 / HB700

IMPORTANT! Read the following instruction manual carefully before use.
Keep this user manual safe for future reference.

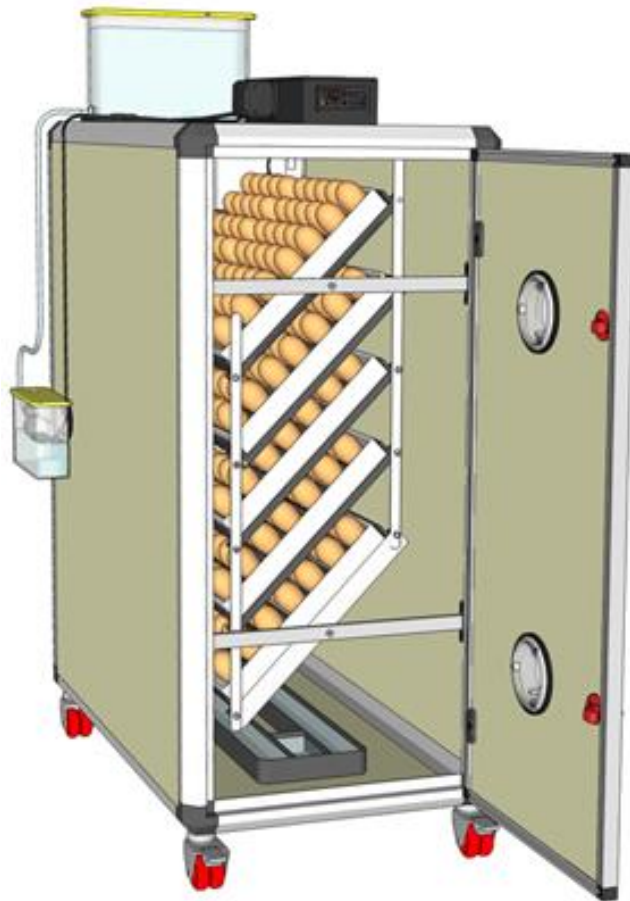

USER MANUAL

<i>HB SERIES Models.....</i>	<i>2</i>
<i>Parts of Models.....</i>	<i>3-4</i>
<i>Quick Guide.....</i>	<i>5</i>
<i>Placement of Models.....</i>	<i>6</i>
<i>Ventilation.....</i>	<i>6</i>
<i>Egg Handling.....</i>	<i>7</i>
<i>Temperature / Humidity Controller.....</i>	<i>7-10</i>
<i>USB Connection / Room Sensor.....</i>	<i>11</i>
<i>Humisonic™ Auto-Humidity Control.....</i>	<i>12</i>
<i>Humidity Tray.....</i>	<i>13</i>
<i>TurnX™ Automatic Turning System.....</i>	<i>14</i>
<i>Setter Trays and Hatchery Baskets.....</i>	<i>15-16</i>
<i>Active Periodic Cooling (APC).....</i>	<i>17-20</i>
<i>Setting and Hatching.....</i>	<i>21-23</i>
<i>Incubation Records.....</i>	<i>24</i>
<i>Factors Affecting Hatchability.....</i>	<i>24</i>
<i>Cleaning up and Service.....</i>	<i>25</i>
<i>Safety Labeling.....</i>	<i>25</i>
<i>Product Information.....</i>	<i>26</i>
<i>Recommended Incubation Values.....</i>	<i>27</i>

HB SERIES

Models

Setter Models (S)

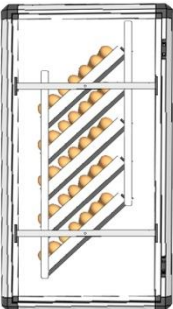

HB175 S

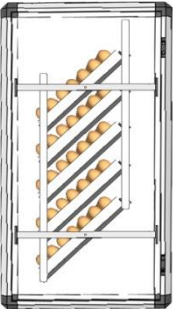

HB350 S

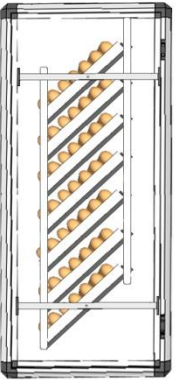

HB500 S

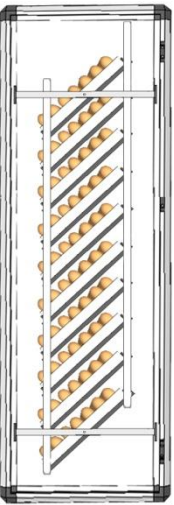

HB700 S

Hatcher Models (H)

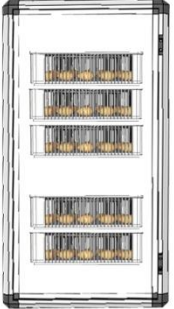

HB175 H

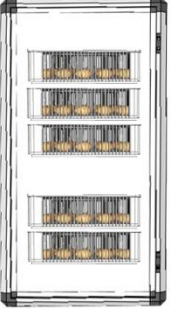

HB350 H

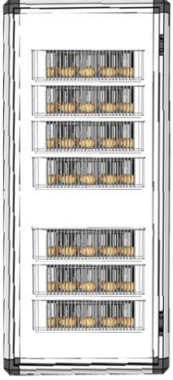

HB500 H

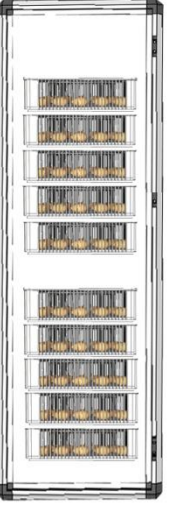

HB700 H

Combined Models (C)

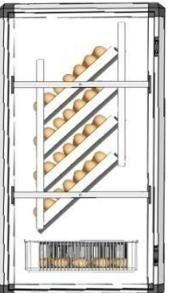

HB175 C

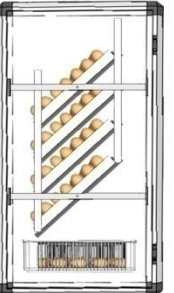

HB350 C

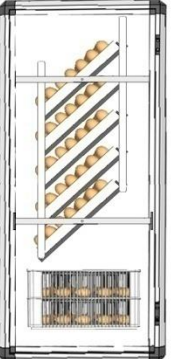

HB500 C

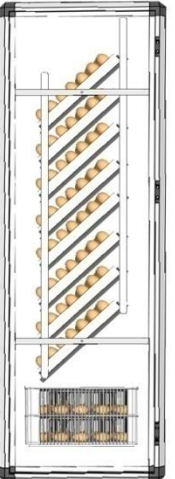

HB700 C

HB SERIES

Parts of Models

- | | |
|----|--|
| 1 | Water Reservoir - (1 Gallon) |
| 2 | Humisonic™ Adapter |
| 3 | Control Panel |
| 4 | Temperature / Humidity Sensor |
| 5 | Flexy35 Setter Tray (C & S Models) |
| 6 | Back Door for Cleaning and Servicing |
| 7 | TurnX™ Unit (C & S Models) |
| 8 | Humisonic™ Reservoir |
| 9 | CS35Y Hatchery Baskets (C & S Models Only) |
| 10 | Humidity Tray |
| 11 | Lockable Wheels |
| 12 | TurnX™ Control Adapter |
| 13 | Adjustable Exhaust (air-out) Holes |
| 14 | Observation Windows |
| 15 | Adjustable Intake (air-in) Hole |
| 16 | Power Switch |
| 17 | Protection Fuse (F type) |
| 18 | Spare Fuse (F type) |
| 19 | USB Connection |
| 20 | Room Sensor Chip |
| 21 | Room Sensor Cover |

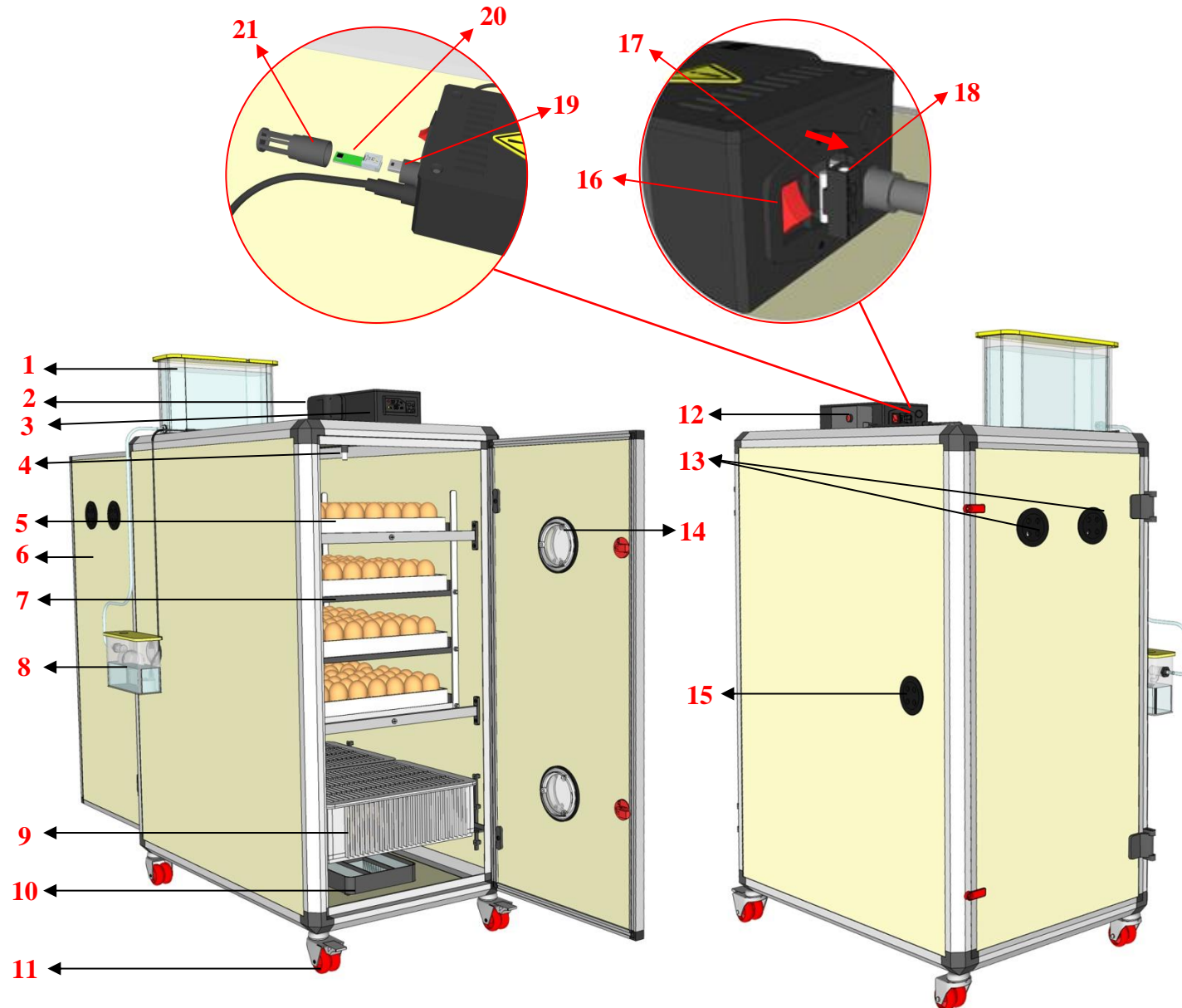

Accessories

	HB175			HB350			HB500			HB700		
	C	S	H	C	S	H	C	S	H	C	S	H
Flexy35	4 pc	5 pc	-	8 pc	10 pc	-	10 pc	14 pc	-	16 pc	20 pc	-
Separators for Flexy	40 pc	50 pc	-	80 pc	100 pc	-	100 pc	140 pc	-	160 pc	200 pc	-
CS35Y	1 pc	-	5 pc	2 pc	-	10 pc	4 pc	-	14 pc	4 pc	-	20 pc
Cover for CS35Y	1 pc	-	2 pc	2 pc	-	4 pc	2 pc	-	4 pc	2 pc	-	4 pc
TurnX™ Adapter	1 pc	1 pc	-	1 pc	1 pc	-	1 pc	1 pc	-	1 pc	1 pc	-
Humisonic™ Unit	1 pc	1 pc	1 pc	1 pc	1 pc	1 pc	1 pc	1 pc	1 pc	1 pc	1 pc	1 pc
Power Cable	1 pc	1 pc	1 pc	1 pc	1 pc	1 pc	1 pc	1 pc	1 pc	1 pc	1 pc	1 pc
Humidity Tray - WT02	1 pc	1 pc	1 pc	-	-	-	-	-	-	-	-	-
Humidity Tray - WT03	-	-	-	1 pc	1 pc	1 pc	1 pc	1 pc	1 pc	1 pc	1 pc	1 pc
Hatchery cover for Flexy35	Optional	Optional	-	Optional	Optional	-	Optional	Optional	-	Optional	Optional	-

Flexy35

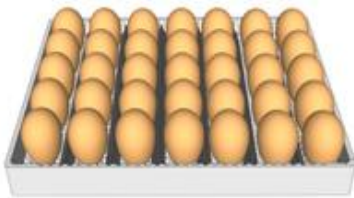

Separator for Flexy35



CS35Y



Cover for CS35Y



TurnX™ Adapter

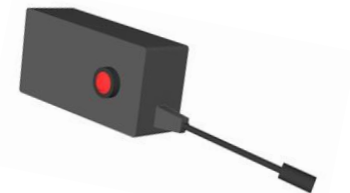

Humisonic™ Unit



Power Cable



Humidity Tray - WT02

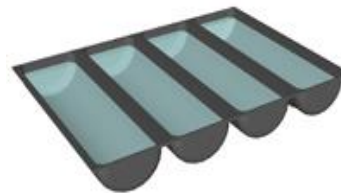

Humidity Tray - WT03



Hatchery cover for Flexy35



Quick Guide

- Remove all packing material carefully.
- Identify and inspect all parts of model. (See Pages 2-4)
- Install Humisonic™ unit into cabinet. (See Page 11)
- Fill humidity tray with water (at least 1 channel). **Picture 1**
- Adjust Flexy35 separators to the size of the eggs you are setting. **Picture 2**
- Plug in your TurnX™ / Humisonic™ adapters to the control panel, then plug your machine into the power supply. **Picture 3**
- Press power button and set the temperature and humidity for your eggs. **Picture 4** (See Pages 8-9)

CAUTION! Do not use equipment with high electric consumption in the same electrical line as your egg incubator.

CAUTION! Always use a grounded power line for your incubator.

CAUTION! Run the incubator for 3-4 hours before first use to test the parts and functionality.

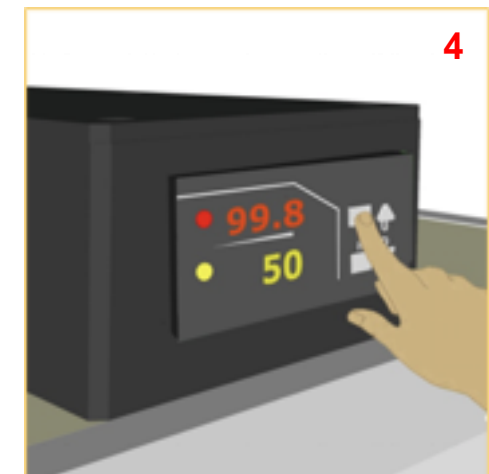
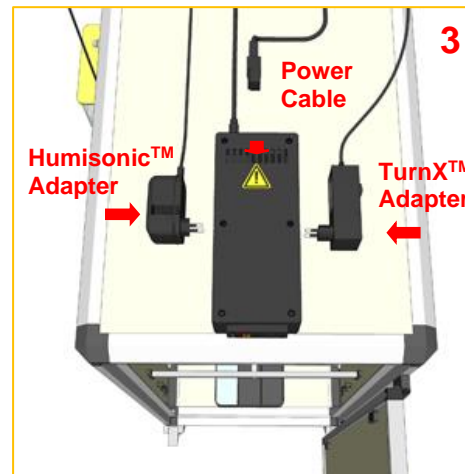
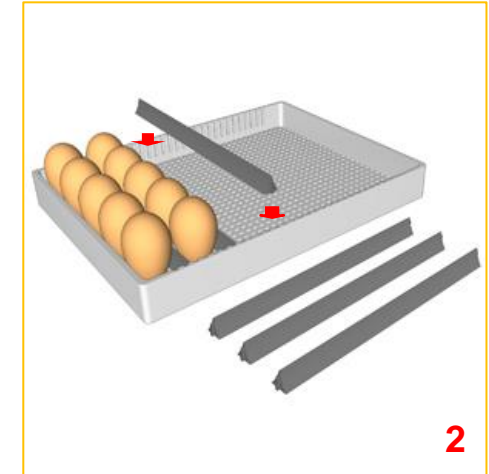
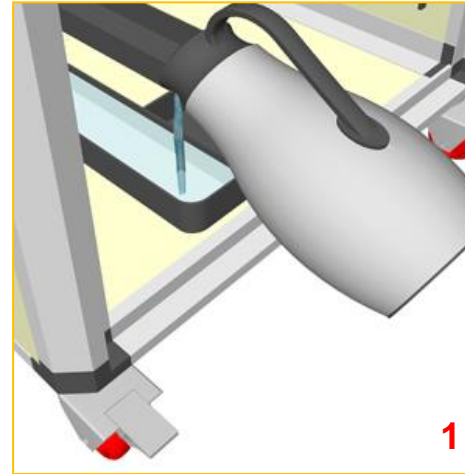

Placement of Model

Your incubator must be located indoors. Place your incubator on a flat surface, away from doors and windows. **Ideal distance from any wall is 1½ ft (50cm)**. The area must be clean and well ventilated. The incubator should not be exposed to direct sunlight, water, or high humidity levels.

Ideal incubation room temperature is 68-77°F (20-25°C). Wide temperature variations in the room will negatively affect your incubation results. Consider using an air conditioner or heater to maintain room temperature.

Caution! Do not let room temperature go **below 59°F (15°C) or above 86°F (30°C)**.

Caution! Do not let other animals and insects near the incubator.

Caution! Do not let children operate the equipment.

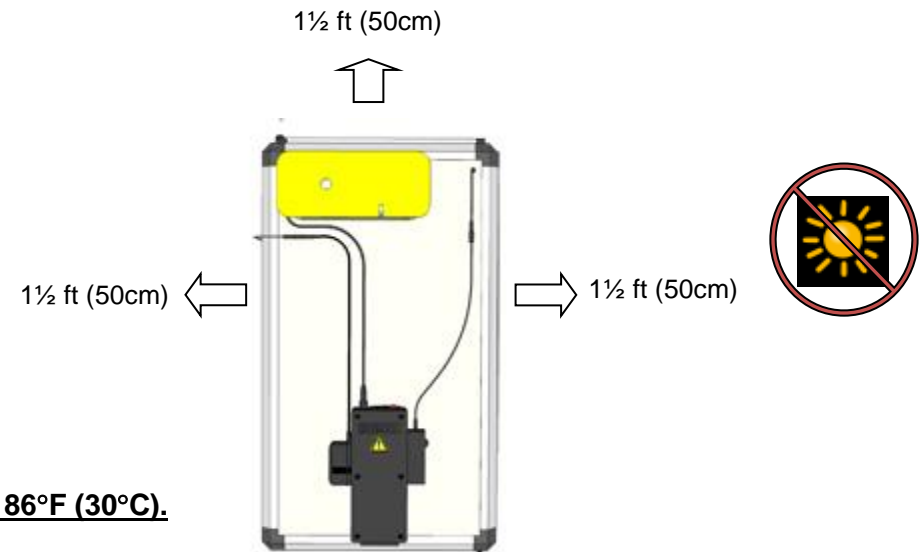

Ventilation

During incubation embryos produce carbon dioxide. Ventilation is required to remove carbon dioxide and maintain the correct oxygen levels.

Ventilation is supplied automatically with a fan and adjustable air holes.

Air holes are adjusted by turning the vent to increase/decrease the amount of air in/out. The amount of ventilation required will depend on egg size and quantity.

Caution! Never close air holes.

Caution! Always keep air holes fully open during hatching period.

Caution! Never breed animals in your incubation room.

Caution! Be sure incubation room is well ventilated.

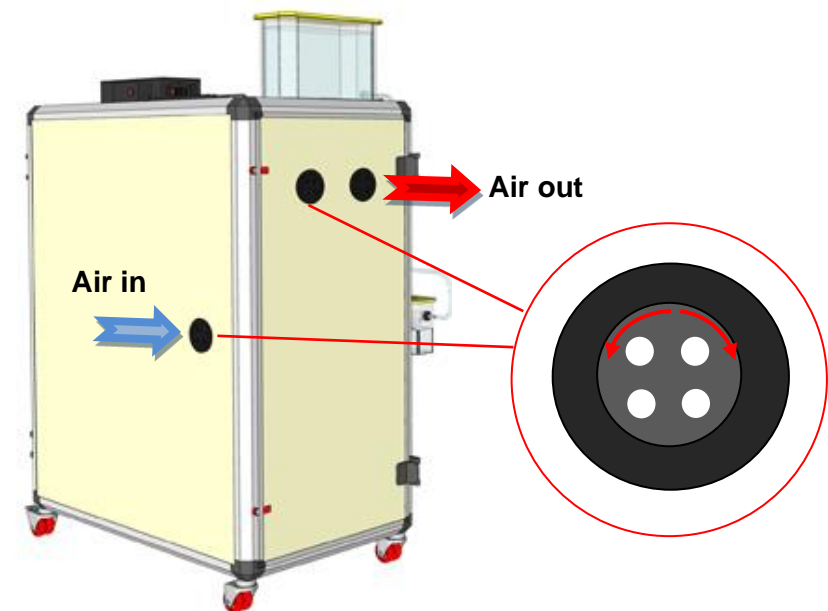

Egg Handling

Eggs should be collected and stored in proper conditions prior to setting. Good quality eggs are important for positive hatchery results. Sanitizing eggs before storage is an effective method for killing or decreasing the number of microorganisms on the egg's surface. Be sure to use proper sanitary procedures, the sanitation process kills bacteria on the egg but it can also kill the chick embryo in the egg.

Ideal egg storage temperature is **53-55°F (12-13°C)** but can be stored in conditions **between 50-68°F (10-20°C)** as necessary, never expose eggs to sunlight. Daily turning of eggs is suggested during storage to maintain hatchability.

CAUTION! Never store eggs in refrigerator - 39°F (4°C) is too cold.

CAUTION! Do not store eggs for more than 7 days as this decreases the egg quality and hatchability.

CAUTION! Eggs must be stored for at least 1 day before setting.

CAUTION! Use proper cleaning methods to clean dirty eggs, never use a cloth to clean eggs.

Temperature / Humidity Controller

The most important factor for successful egg incubation is temperature. Temperature is preset for chicken eggs but can be manually adjusted for all other eggs.

Embryos tolerate short term temperature drops but higher than ideal temperatures can be detrimental. Validate your temperature setting is accurate with a second thermometer. Do not be concerned about short term cooling of eggs when opening door for water or inspections.

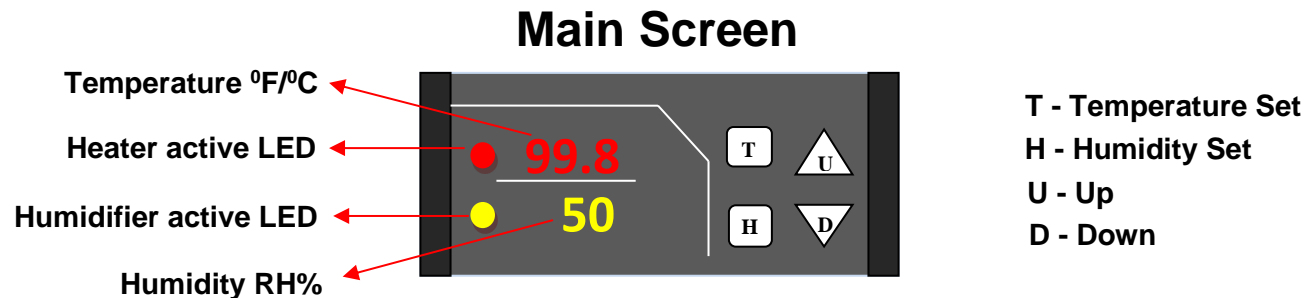

To check temperature set point

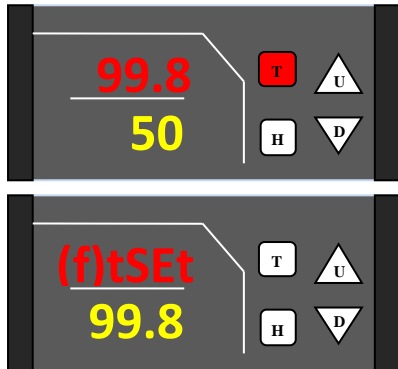

When main screen is active,
Press **T** button and release

(f)tSEt – Temperature Set Screen
will appear for 2 second and turn
back to main screen.

Lower value is temperature set point.

To check humidity set point

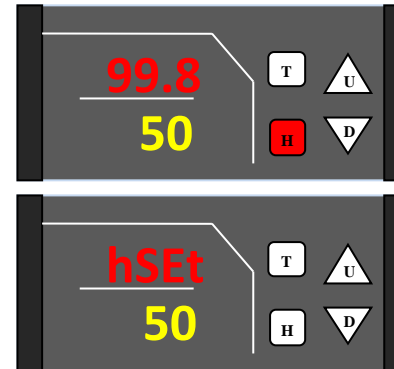

When main screen is active,
Press **H** button and release

hSEt – Humidity Set Screen
will appear for 2 seconds and turn
back to main screen.

Lower value is humidity set point.

To change temperature set point

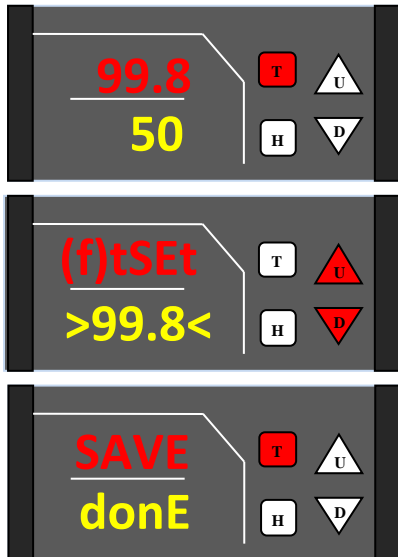

When main screen is active,
Hold **T** button for 2 seconds

While temperature set value blinks
Use **U / D** buttons to adjust
temperature set point

When finished adjusting,
Press **T** button to “save” chosen value.

To change humidity set point

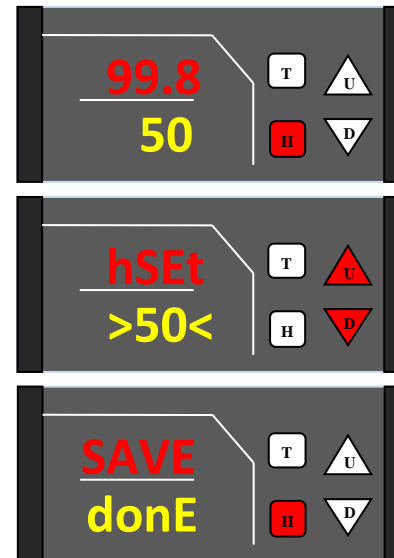

When main screen is active,
Hold **H** button for 2 seconds

While humidity set value blinks
Use **U / D** buttons to adjust
humidity set point

When finished adjusting,
press **H** button to “save” chosen value.

Recommended temperature and humidity values for different species are on page 27

Turn Light On

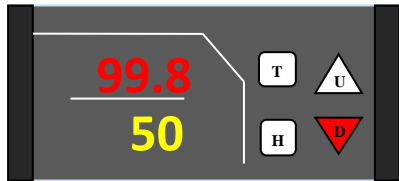

When main screen is active,
Press D button to light on and off.
The light bulb will automatically turn off after 3 minutes.

To Lock Screen on/off

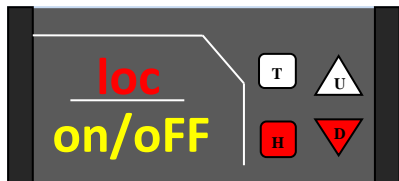

When main screen is active,
Hold H+D buttons together for 3 seconds to lock and unlock screen

Alarm delay



When main screen is active,
Hold U button for 3 seconds
 Alarm will be delayed for 15 minutes.

Second Sensor / Remaining time until next cooling

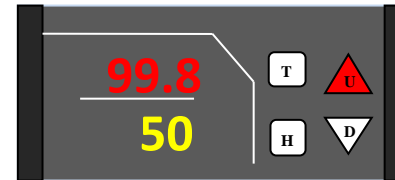

When main screen is active,
 Press **U** button and release to check second sensor values and remaining time for next cooling
Note: Second sensor value will only appear if second sensor is activated
 Check user menu parameters (See Page 10)

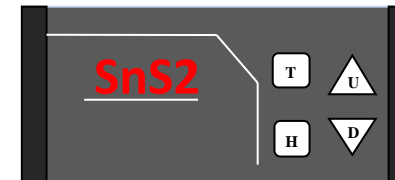

SnS2 will appear.

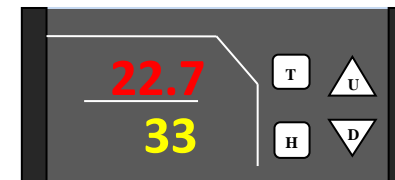

Then, second sensor temperature and humidity values will appear.

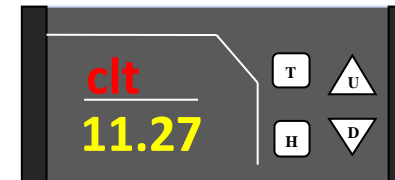

Then remaining time until next periodic cooling will appear.
Note: Remaining time to next cooling will appear if periodic cooling function is on
 Check APC menu (See Page 18)

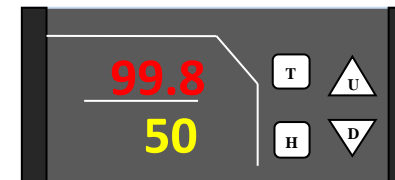

Then, screen turns back to main screen.

User Menu Parameters

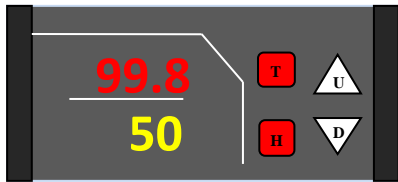

Hold T + H together for 3 seconds to enter menu
 - Use T/H buttons to choose parameters.
 - Use U/D buttons to change set values.
 - Hold T + H together for 3 seconds to save changes.

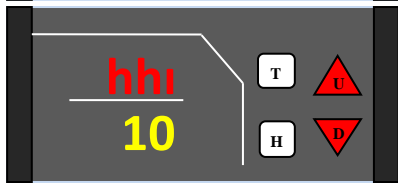

hhi: high humidity alarm
 Started: set value +10
 Delay time: 20 minutes
 Notification: Alr 5
 Alarm: continuous

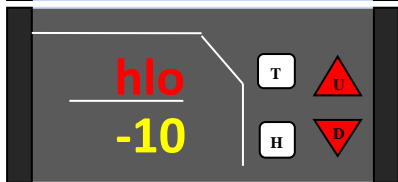

hlo: low humidity alarm
 Started: set value -10
 Delay time: 20 minutes
 Notification: Alr 6
 Alarm: intermittent

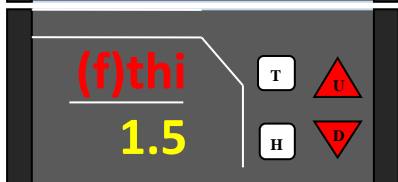

(f)thi: high temperature alarm
 Started: set value +1.5
 Delay time: 2 minutes
 Notification: Alr 1/3
 Alarm: continuous

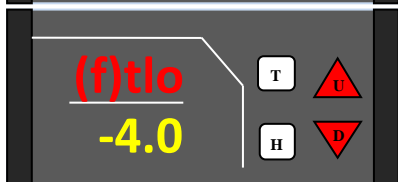

(f)tlo: low temperature alarm
 Started: set value -4.0
 Delay time: 30 minutes
 Notification: Alr 2/4
 Alarm: intermittent

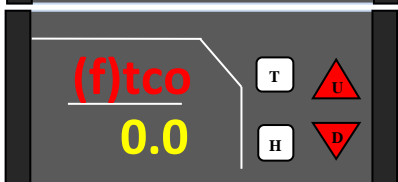

tco: temperature calibration value
CAUTION! tco is a critical parameter. Changing this can result in chick loss. Use qualified and calibrated glass or electronic thermometers for calibrating. Check temperature values regularly.

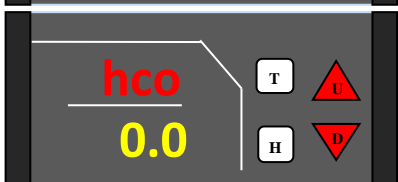

hco: humidity calibration value
CAUTION! hco is a critical parameter. Changing this can result in chick loss. Use qualified and calibrated glass or electronic thermometers for calibrating. Check humidity values regularly.

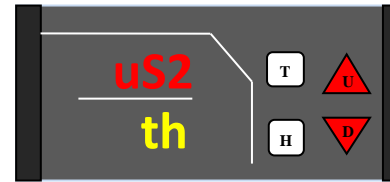

US2: USB connected device
 no: no connected device
 th: second sensor connected (room/calibration)
 iot: iot module connected
 Notification: Alr 15 (usb connection error)

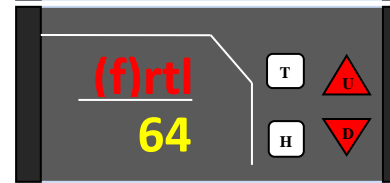

Below parameters active if Us2 is selected "th"
(f)rtl: second sensor low temperature alarm
 Started: below 65°F (18°C)
 Delay time: no
 Notification: Alr 12
 Alarm: intermittent

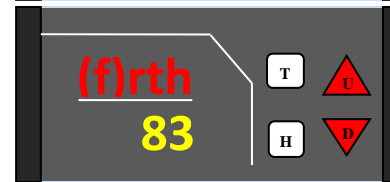

(f)rth: second sensor high temperature alarm
 Started: over 83°F (28°C)
 Delay time: no
 Notification: Alr 11
 Alarm: intermittent

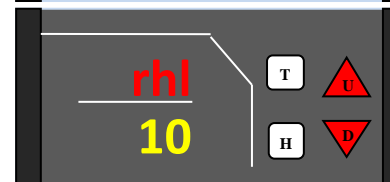

rhl: second sensor low humidity alarm
 Started: below 10 RH
 Delay time: no
 Notification: Alr 14
 Alarm: intermittent

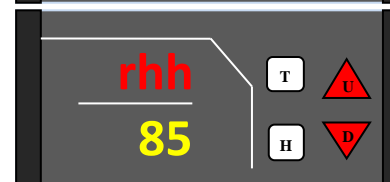

rhh: second sensor high humidity alarm
 Started: over 85 RH
 Delay time: no
 Notification: Alr 13
 Alarm: intermittent

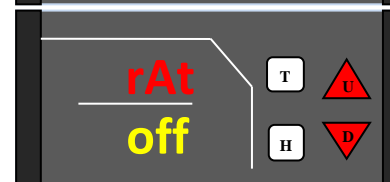

rAt: second sensor temperature alarm activation
 On: alarms activated
 Off: alarms deactivated

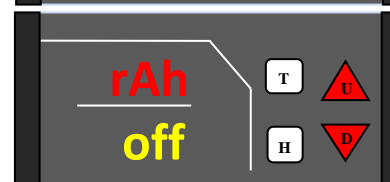

rAh: second sensor humidity alarm activation
 On: alarms activated
 Off: alarms deactivated

USB Connection / Room Sensor

Your incubator is equipped with a room sensor installed through USB connection. The room sensor measures the temperature and humidity conditions of the room. The room sensor is identical to the main sensor inside the egg incubator, it can be used as a spare sensor in emergency situations. The incubator is complete with alarms to help you monitor high/low temperature and humidity.

USB connection can also be used for calibration sensors. Connection device should be selected from the user menu on the display. Additional USB accessories for your incubator coming soon!

CAUTION! Always power off the incubator during any sensor installation.

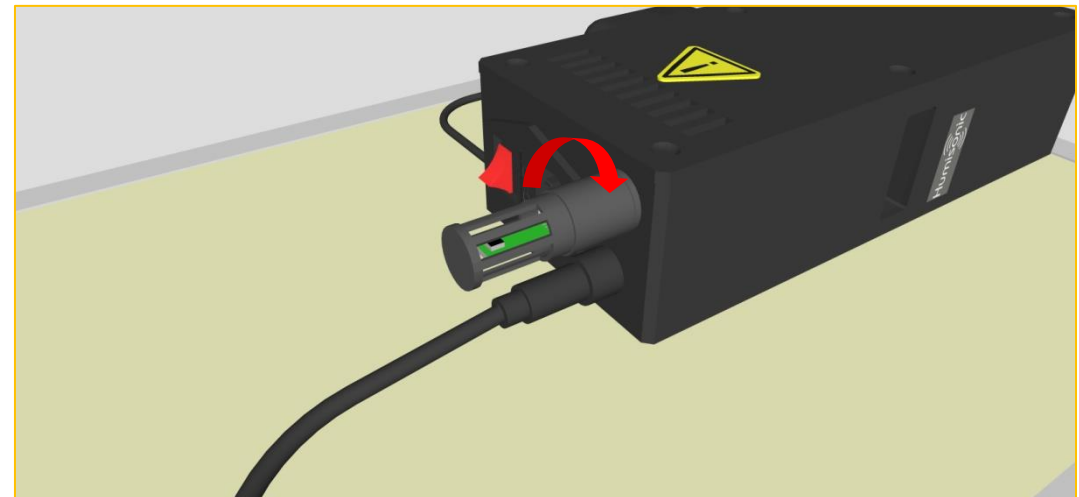
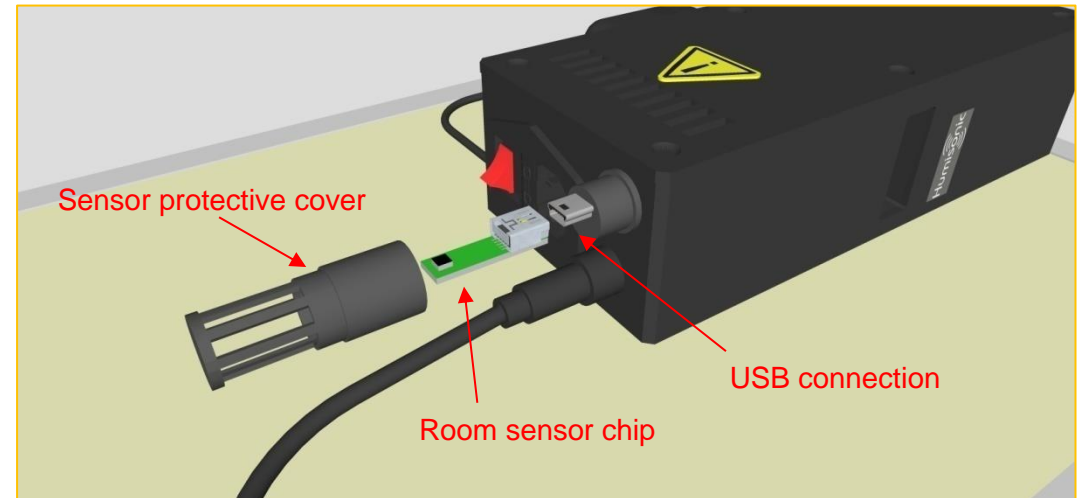

Humisonic™ Automatic Humidity Control

Humidity adjustments are required to provide adequate water loss from eggs. Eggs need to lose between 13-16% of water depending on the species. Weighing your eggs during incubation is the most reliable way to ensure you have reached proper humidity levels for your eggs.

Short term humidity changes during incubation are not impactful. Keeping an average humidity (See Page 27) during the entire incubation period is enough to achieve good results. However, **high humidity levels during the hatching period (last 2-3 days) are very important.** When the chicks start to hatch, the inner membranes of the eggs dry quickly. This causes membranes to harden, and chicks can stick to their shell. To prevent the drying of the membranes, humidity must be adjusted to high levels for the last 2-3 days of incubation.

Installation

- Connect Humisonic™ reservoir to the incubator.
- Place stainless steel Humisonic™ unit into the bottom of the reservoir.
- Use flexible hose to connect water tank and Humisonic™ reservoir.
- Connect Humisonic™ cable to Humisonic™ adapter. Connect adapter to the control panel.
 - o The float valve will keep water level 1-2cm (.4-.8") above water level sensor.

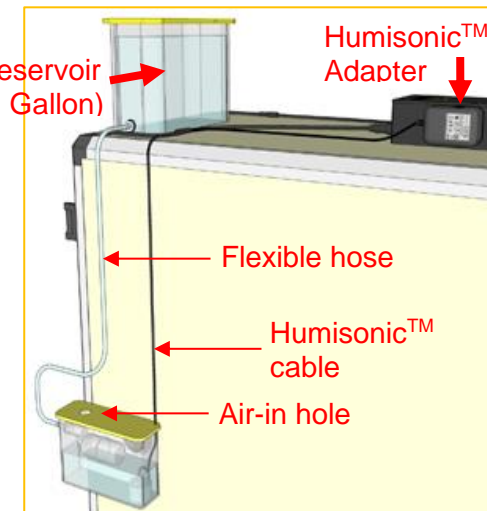
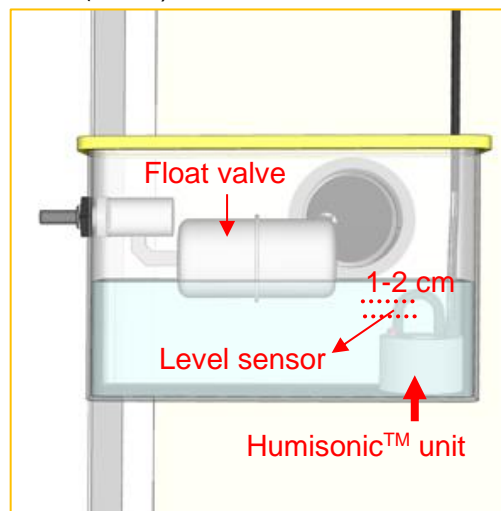
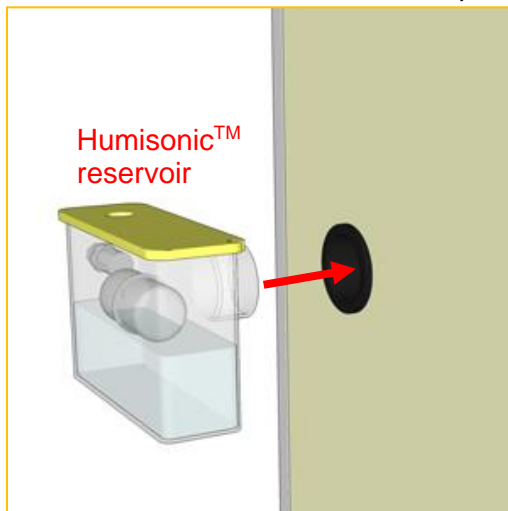

CAUTION! Do not use hard or lime-enriched water for either the humidifier system or humidity tray. Change humidifier disks regularly. Humisonic™ humidifier units are designed for on / off use. Leaving the unit on for prolonged periods of time will decrease the life of the unit. Never cover the air-in hole on Humisonic™ reservoir cover.

Humidity Tray

Cabinet humidity values can be adjusted manually by adding water to humidity tray channels. Check humidity values on the control panel. Humidity levels directly relate to the amount of water in the humidity tray. HB SERIES models have different sized water channels so that humidity can be adjusted to desired level.

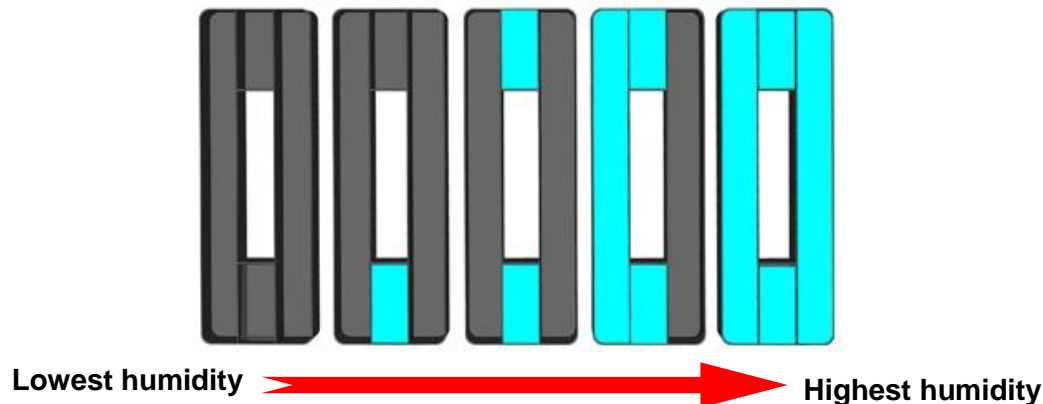

CAUTION! Never fill humidity tray with cold water. Use warm water close to incubator's temperature set point. Ideally 77-86°F (25-30°C)
CAUTION! Humidity tray is part of the incubator. Always keep it in bottom, even when empty. Keep at least one channel of the humidity tray full during setting period and keep full for hatching period (last 2-3 days).

Keeping water in humidity tray offers many advantages:

- Acts as a backup water supply in case your external water tank runs out of water or if there is an unexpected malfunction.
- Prolongs the life of your Humisonic™ unit.
- Less power consumption resulting in lower energy costs.

Don't forget that humidity values depend on temperature values, always validate humidity values at the temperature set point.

TurnX™ Automatic Turning System

TurnX™ Automatic turning system provides 90° (45° in each direction) turning every hour. TurnX™ linear actuator is controlled by TurnX™ control adapter. The “Turner button” allows you to manually adjust the position of the egg racks.

CAUTION! Only use the “Turner button” to reset the setter trays in a horizontal position.
CAUTION! Do not try to set or take out trays before getting them in a horizontal position.

Adjust setter trays into a horizontal position:

- Push and release the “Turner button” to start turning
- When the trays become horizontal, switch the incubator off
- Turn incubator on after inserting or removing racks/baskets

CAUTION! Flexy35 trays must sit properly within incubator. Before switching the incubator “on”, check all trays. Otherwise, trays or turning mechanism can be damaged.

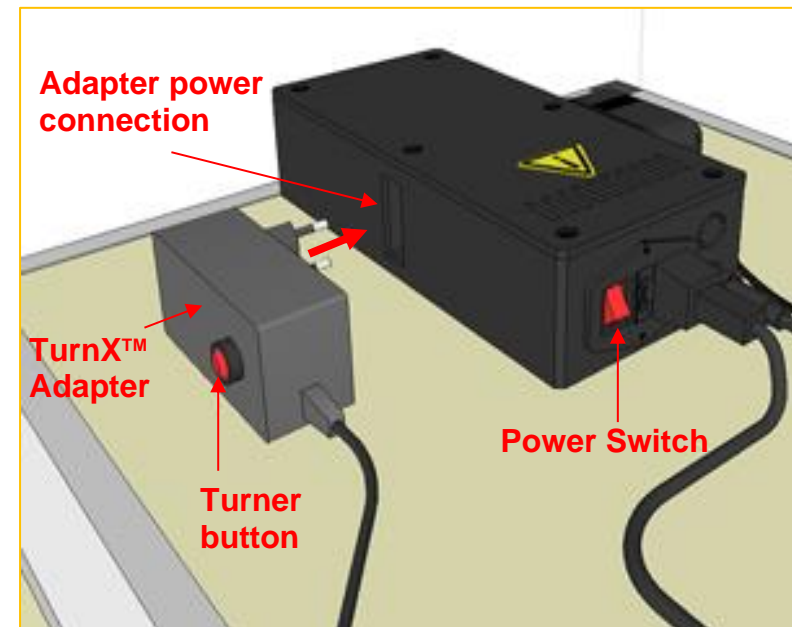

Setter Trays and Hatchery Baskets

Flexy35 Universal Setter Tray

HB SERIES Setter (S) and Combined (C) models come with **Flexy35** universal egg setter trays. **Flexy35** separators can be adjusted for different egg sizes. Each Flexy35 tray comes with 10 separators and can be adjusted for any size egg, from quail to goose eggs.

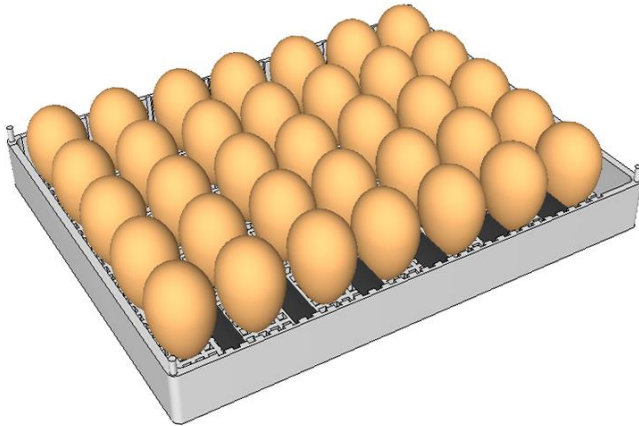

CAUTION! Never set eggs with the small end up. Eggs must be set with small end down or horizontal.

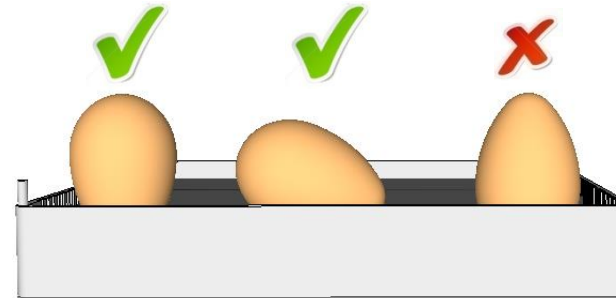

Goose and peacock eggs must be set horizontally with small end tilted down

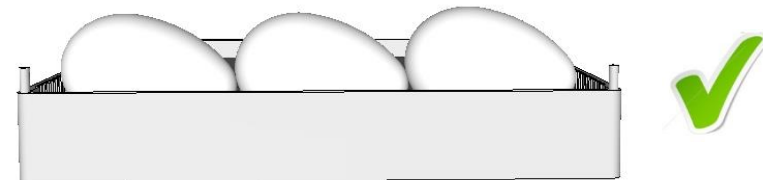

	Approximate Egg Capacities	Setting
Chicken / Duck	35	6 separators / 7 line x 5 egg
Quail	99	10 separators / 11 line x 9 egg
Partridge	56	8 separators / 8 line x 7 egg
Pheasant	48	7 separators / 8 line x 6 egg
Turkey / Big Duck	24	5 separators / 6 line x 4 egg
Goose / Peacock	15-20	4 separators / 5 line x 3-4 egg

CAUTION! Before setting Flexy35 trays to TurnX™ mechanism, make sure that separators are placed properly and check that no eggs fell during 45° turning.

HB SERIES

CS35Y Hatchery Basket



Eggs are transferred to hatchery baskets for the last 2-3 days of incubation.

Typical Egg Capacities	
Chicken / Duck	35
Quail	99
Partridge	56
Pheasant	48
Turkey / Big Duck	24
Goose / Peacock	15-20

Combined (C) Models have an internal hatchery section for hatchery baskets.

Hatcher (H) Models have shelves for hatchery baskets and all hatchery baskets are reachable separately for easy access to chicks.

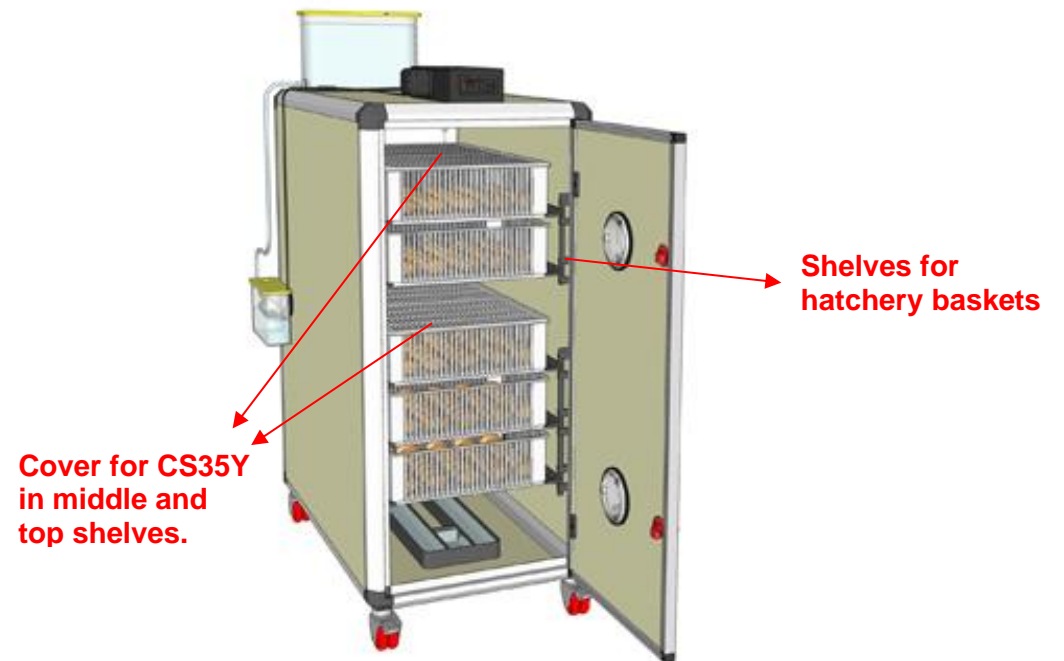

Active Periodic Cooling (APC)

CAUTION! Active periodic cooling function is for professional users only. If needed, please seek assistance from your vendor. Results can change for a variety of reasons including poultry species, egg size, and room conditions. Improper cooling can result in late hatching and chick loss.

In natural incubation, most birds leave the nest for a period of time at least once after the first week of incubation. Eggs cool and dehumidify during this period. **Active periodic cooling (APC)** lets you mimic this natural behavior.

Research shows that periodic cooling of goose, duck and even chicken eggs during incubation has positive effects on hatch rates and chick quality. Periodic cooling is very important for most goose types. Without periodic cooling, goose egg hatch rates can decrease by up to 20-30%. Many breeders manually cool the eggs by taking them out of the incubator, let them cool in hatchery room conditions, and spray the eggs with warm water before placing them back in the incubator again.

To automate the process, Cimuka uses **Active Periodic Cooling (APC)** with 2 different modes to simulate natural behavior. All alarms for temperature and humidity will be off during this time. After APC is complete, temperature and humidity will return to preset parameters.

1. **(clt) Cooling for a time mode**

- System turns off heat and humidity (for models with humidifier) for an adjusted time.

2. **(cIS) Cooling for a set mode**

- System turns off heat and humidity (for models with humidifier) and drops temperature to an adjusted temperature set point and keeps the temperature at this point for a set amount of time.

Models include 2 more modes:

1. **Humidification mode** (for models with humidifier) – before cooling period ends, high humidity is applied
2. **Fan assistant cooling mode** (for models with cooling fan) - reaches desired cooling temperature faster

Cimuka 's advanced incubator controller allows users to change all parameters with Active Periodic Cooling (APC) menu. Now experienced breeders can work outside of preset parameters to achieve the best hatch rates for their eggs.

Active Periodic Cooling (APC)

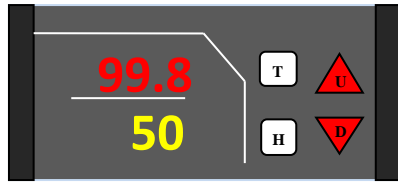

Hold U + D together for 3 seconds to enter menu

- Use T/H buttons to choose parameter.
- Use U/D buttons to change parameter values.

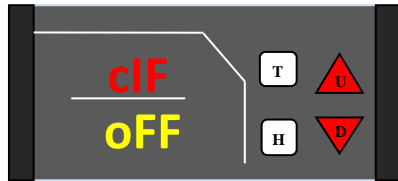

cIF: Active Periodic Cooling (APC) function activation

oFF: Active Periodic Cooling is deactivated.

cLt: “cooling for a time” mode - Stops heater and humidifier for “hct” time. (check hct parameter)

cLS: “cooling for a set” mode - Stops heater and humidifier up to an adjusted temperature set point and keep temperature at this point for an adjusted time. (check cSt/FSt)

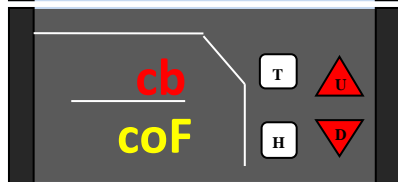

cb: Active Periodic cooling Starting

con: first cooling starts immediately after save the menu.

coF: first cooling starts after periodic cooling cycle (cPr)

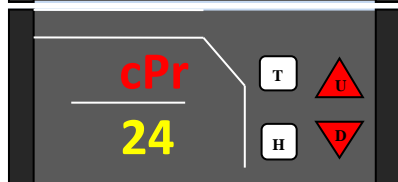

cPr: Periodic cooling cycle time (hours)

6-8-12-24-48-72 hours selectable.

System repeats cooling in this cycle.



cSt: cooling set point (C display models)

cooling set value: temperature set point – cSt (-8°C)

note: cSt is only active in cLS mode on C display models

Example: for a system working on 37.7°C, system cools up to 29.7°C (37.7°C - 8.0°C = 29.7°C)



FSt: cooling set point (F display models)

cooling set value: temperature set point – FSt (-15°C)

note: FSt is only active in cLS mode on C display models

Example: for a system working on 99.8°F, system cools up to 84.8°F (99.8°F - 15.0°C = 84.8°F)

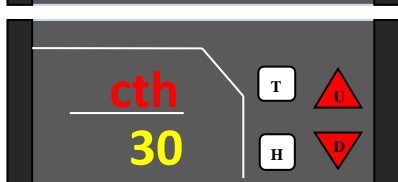

cth: waiting time in cooling set point. (minute)

Waiting time of system in cooling set point

cth is only active in cLS mode

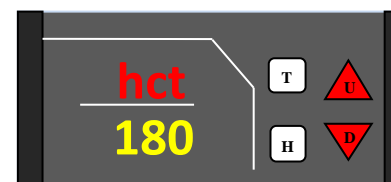

hct: max cooling time (minute)

Heater/humidifier cut off time for clt mode.

Maximum cooling time for cLS mode.

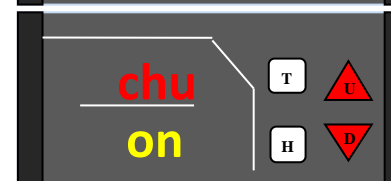

chu: humidification activation during cooling (Only for models equipped with humidifier)

on: humidification activated

oFF: humidification deactivated

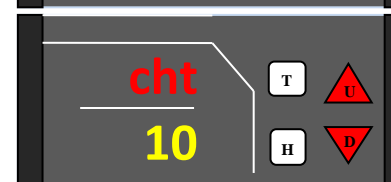

cht: Humidification time in cooling (minute) (Only for models equipped with humidifier)

Humidification will start before cooling finished for cht time.

Example: If cooling will finish within 30 minutes, humidification starts after 20 minutes (30-10=20) (Page 21)

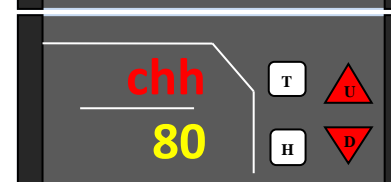

chh: max humidification set in cooling (RH%) (Only for models equipped with humidifier)

Humidifier works up to this set and keeps incubator in this point during humidification period.

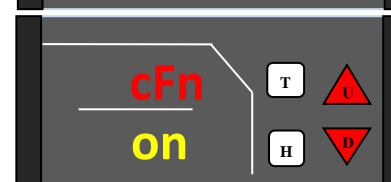

cFn: cooling fan activation

(Only for models equipped with cooling fan)

On: cooling fan is activated during cooling.

OFF: cooling fan is deactivated during cooling.

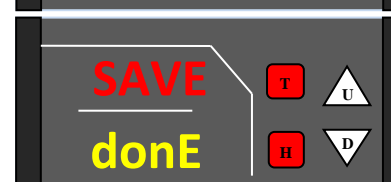

Hold T+ H together for 3 seconds to save changes

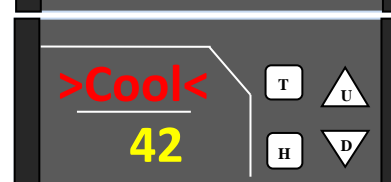

During cooling, “cool” blinks on screen,

CAUTION! Do not cut the power of incubator during cooling. Power failure will terminate cooling but the time for cooling period will continue.

Cimuka's research team is collecting data from their research center and from customers for different APC applications. **The table below outlines the recommended parameters for cooling for a set (cIS) mode.**

Note: Cooling by a time (clt) mode is highly dependent on hatchery room conditions and the number of eggs in the incubator. It is advisable to use a temperature-controlled hatchery room to reach optimal hatching results.

Active Periodic Cooling (APC) Parameters	Display	Factory Setting	Chicken	Duck	Goose
Cooling mode	clF	oFF	cIS On at 8th day Off at 19th day	cIS On at 8th day Off at 25th day	cIS On at 8th day Off at 27th day
Cooling start time	cb	cof	con	con	con
Cooling cycle time	cPr	24 h	24	24	24
Cooling set point °C (set - adjusted data)	cSt	-8.0°C	-8.0	-8.0	-8.0
Cooling set point °F (set - adjusted data)	FSt	-15.0°F	-15.0	-15.0	-15.0
Waiting time in cooling set point	cth	20 min	10 min - 8th to 13th 20 min - 14th to 18th	10 min - 8th to 15th 25 min - 16th to 25th	10 min - 8th to 14th 20 min - 15th to 21th 40 min - 22th to 27th
Max cooling time	hct	120 min	120 min	150 min	180 min
Humidification*	chu	on	on	on	on
Humidification Time*	cht	10 min	10	15	15
Max humidity during humidification*	chh	80 RH%	80	80	80
Cooling fan activation**	cFn	on	on	on	on

* only for models equipped with humidifier

**only for models equipped with cooling fan

CAUTION! Turn off Active Periodic Cooling (APC) function during hatching period (Last 2-3 days of incubation). Cooling in the last 2-3 days of incubation results in bad hatch rates and chick loss.

CAUTION! Changing cooling mode (clF) or cooling cycle time (cPr) parameters in APC menu resets periodic cooling cycle time (cPr).

CAUTION! In cIS mode, time to reach cooling set point cSt (Fst) is highly dependent on room temperature. For very low set points, system may not be able to reach cooling set point. For such situations, system finalizes cooling at max cooling time (hct).

HB SERIES

Active Periodic Cooling (APC) set at “cooling for a set (cIS)” mode is shown in the graph below with sample parameters.

APC Parameters	Display	Setting
Cooling mode	cIF	cIS
Cooling start time	cb	on
Cooling cycle	cPr	24 h
Cooling set point °C (set - adjusted data)	cSt	-8.0 C
Cooling set point °F (set - adjusted data)	FSt	-15 F
Waiting time in cooling set point	cth	20 min
Max cooling time	hct	120 min
Humidification*	chu	on
Humidification Time*	cht	10 min.
Max humidity during humidification*	chh	80 RH%
Cooling fan activation**	cFn	on

* only for models equipped with humidifier

**only for models equipped with cooling fan

System repeats APC behavior every cooling cycle time (cPr).

In a power outage, cooling cycle time (cPr) is not reset. It will continue from last recorded time.

Example: if there is a 1 hour power outage, the next cooling time will delay about 1 hour.

Remaining time to next cooling can be checked on the controller (See Page 9)

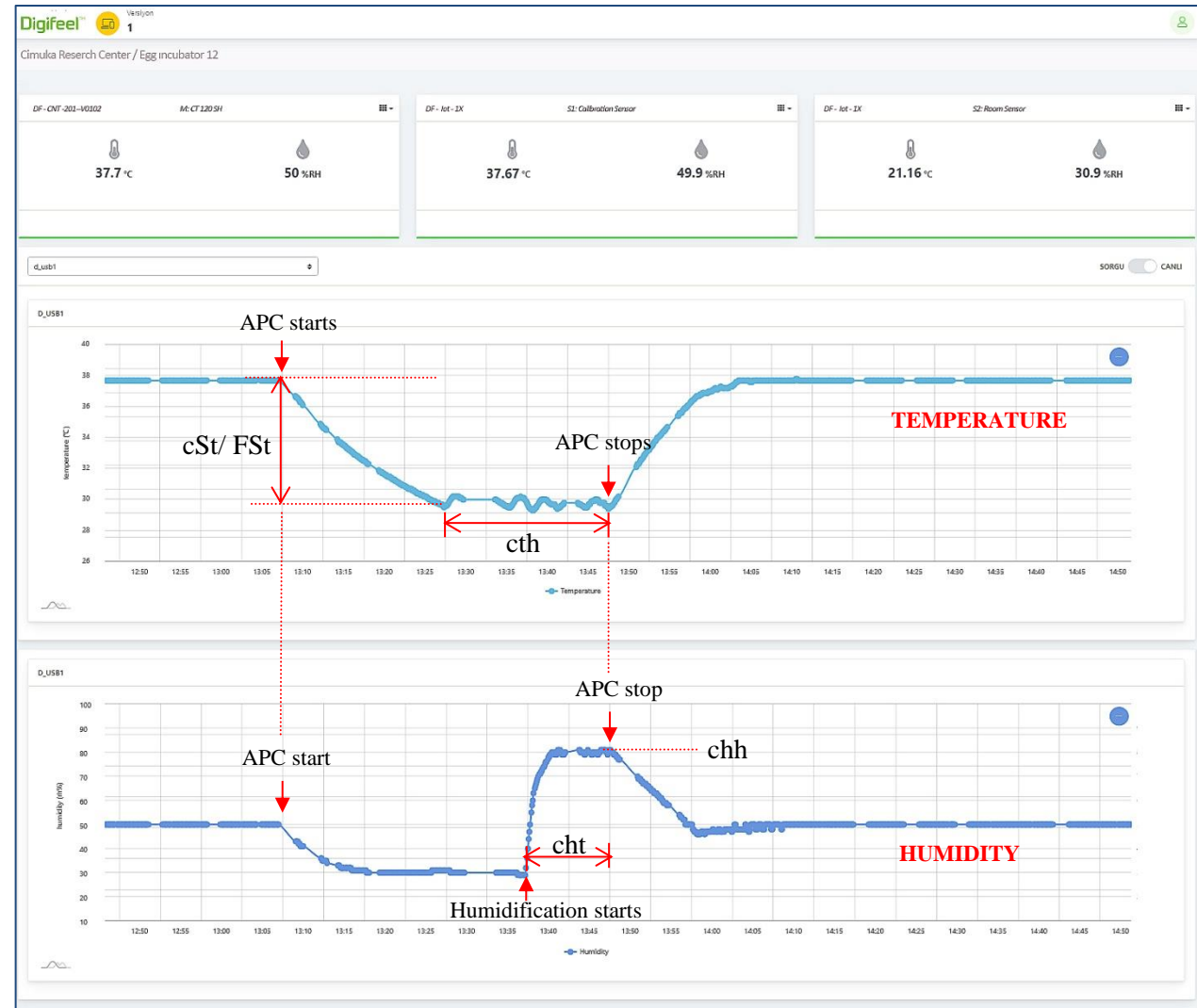

Setting and Hatching

Combined (C) Models – Partial Setting

To decrease egg storage times, in Combined (C) Models, eggs are set partially and periodically every 4-5 days. Eggs must be transferred to the hatchery section for last 2 days of incubation.

CAUTION! Never set more eggs than the hatchery section has capacity for. Allow at least 5 days between settings.

Example: Model: HB175C - 35 chicken eggs, partial setting every 5 days (incubation time = 21 days)

For the first 19 days, eggs must be set in the TurnX™ mechanism. They are transferred to the hatchery section for the last 2 days.

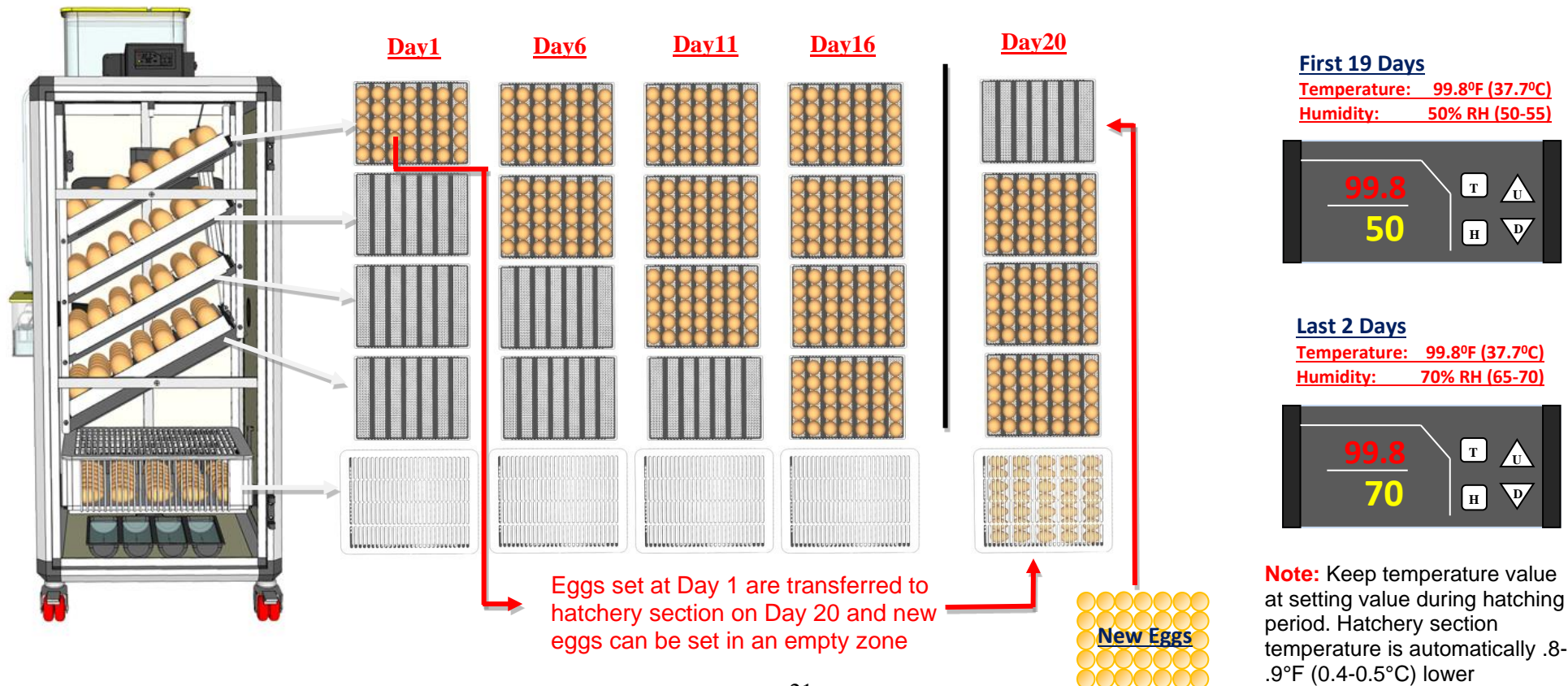

HB SERIES

Setters / Hatchers

HB SERIES offers Setter (S) and Hatcher (H) Models in 4 different capacities from 175 to 700 chicken eggs.

Using a separate hatcher gives users advantages when trying to achieve optimal temperature and humidity values for embryo needs. A separate hatcher also decreases the microbial cross contamination risk between eggs in setter and hatcher.

Example: Chicken Egg (Incubation time = 21 days)

First 18 Days

Temperature: 99.8°F (37.7°C)
Humidity: 50% RH (50-55)

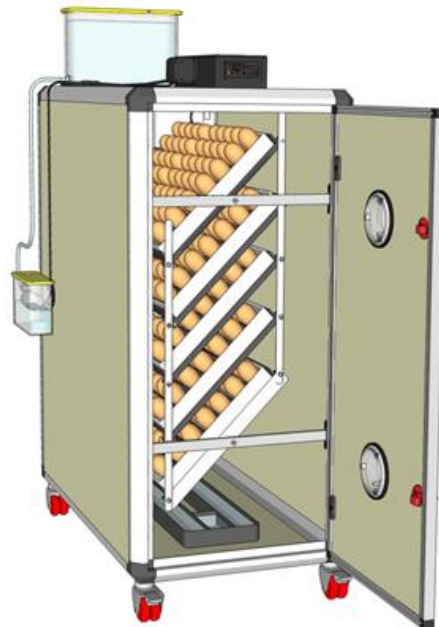
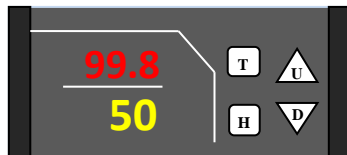

On Day 19,
Transfer to
hatcher



Last 3 Days

Temperature: 99.0°F (37.2°C)
Humidity: 70% RH (65-70)

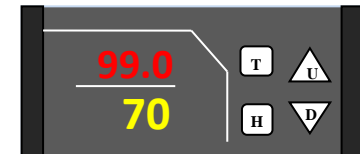

HB SERIES

All Set / All Hatch

Setter (S) and Combined (C) Models can be used for an all set / all hatch setup. Flexy35 egg setter trays can be converted to hatchery baskets by using **Flexy35 hatchery cover**. – *sold separately*

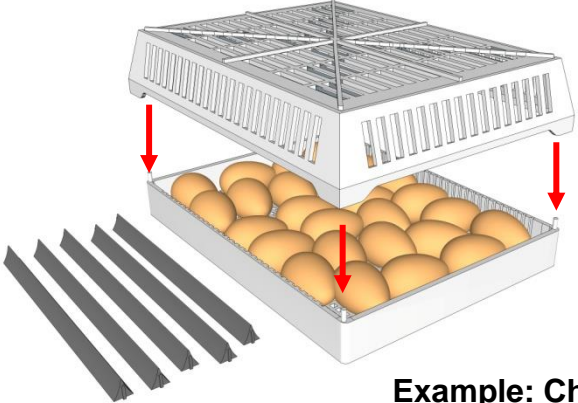

Flexy35 Typical Hatching Capacities

Chicken / Duck	30
Quail	99
Partridge	56
Pheasant	48
Turkey / Big Duck	24
Goose / Peacock	15-20

Example: Chicken Egg (Incubation time = 21 days)

First 18 Days

Temperature: 99.8°F (37.7°C)
Humidity: 50% RH (50-55)

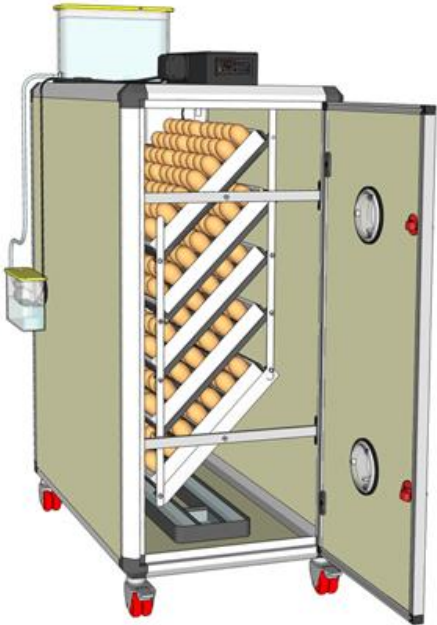
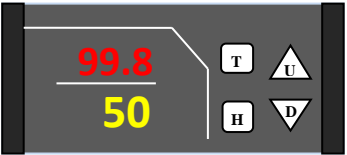

On Day 19,
use Flexy35
hatchery
covers

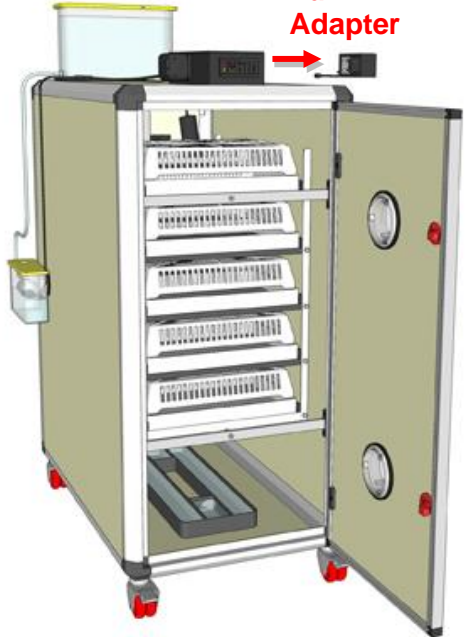

**TurnX™
Adapter**

CAUTION! Always unplug TurnX™ Adapter during hatching. Accidental turning with Flexy35 covers can damage inside parts and turning system.

Last 3 Days

Temperature: 99.0°F (37.2°C)
Humidity: 70% RH (65-70)

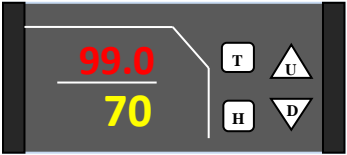

Incubation Records

Keeping personal records is important for identifying performance issues or problems in incubation.

Name of species, setting date, transfer date, first and last hatching date, number of eggs set, number of fertile eggs, number of chicks, and % hatchability should be recorded for future reference. We also suggest candling you eggs to check for infertility.

Hatchability rates can vary by species. Hatchability can be calculated by dividing number of chicks by the number of fertile eggs.

Sample table (Quail incubation time 17 days, chicken incubation time 21 days.)

Species	Date of			Number of			Hatchability %	Notes
	Set	Transfer	Hatching	Eggs	Fertile Eggs	chicks		
Quail	1.1.2000	15.1.2000	18.1.2000	25	20	19	95	16-17 days hatch, 1 early death
Hen	5.1.2000	23.1.2000	26.1.2000	5	4	4	100	20-21 days hatch

Factors Affecting Hatchability

- Incorrect incubation settings
- Turning problems
- Very low / high incubation room temperatures
- Inadequate room ventilation
- Prolonged egg storage times
- Electric outages
- Inadequate or wrong sanitary procedures for eggs or machine
- Very old or very young parents
- Improper or poor parent feeding
- General problems for health of parents
- Illnesses and genetic problems in parents
- Incorrect male / female ratio

Egg incubation requires dedication and oversight. Cimuka, or its distributors will not be held responsible for loss of eggs or chicks under any circumstances

Cleaning Up and Service

- CAUTION!** Disconnect the incubator from electric supply during cleaning or servicing.
- CAUTION!** Servicing and spare part changes must be carried out by a qualified person.
- CAUTION!** Never use water hotter than 122°F (50°C) for cleaning. Electrical parts must be kept dry during cleaning.

Internal parts of cabinet and egg trays must be cleaned after every hatch with a proper sanitary solution. Apply recommended sanitation methods and chemicals for cleaning. Clean your model thoroughly after each season by keeping it on without humidifier unit to dry all parts for at least 1 day. Use a dry soft brush or vacuum to clean control panel and fan panel.

Most components of the incubator are easily replaceable. Always keep critical parts as spares. For spare parts and service needs, contact your vendor.

Safety Labeling



RISK OF ELECTRIC SHOCK!

ALWAYS OPERATE YOUR EGG INCUBATOR WITH GROUNDED POWER SOCKET. NEVER ATTEMPT TO SERVICE UNLESS THE MACHINE IS DISCONNECTED FROM THE MAIN ELECTRICITY SUPPLY. CONNECTIONS INSIDE OF CONTROL PANEL ARE AT MAIN VOLTAGE.



RISK OF ELECTRIC SHOCK!

NEVER ATTEMPT ANY KIND OF SERVICING UNLESS THE MACHINE IS DISCONNECTED FROM THE MAIN ELECTRICITY SUPPLY. THE CABLES, HEATER, FAN AND BULB ARE AT MAIN VOLTAGE.



RISK OF BURN! HOT SURFACE. DON'T TOUCH

NEVER ATTEMPT TO TOUCH THE HEATER INSIDE OF THE VENTILATION PANEL. THE MACHINE MUST BE DISCONNECTED FROM THE MAIN ELECTRICITY SUPPLY AND YOU MUST WAIT AT LEAST 5 MINUTES BEFORE SERVICING.



RISK OF INJURY! KEEP HANDS AND FINGERS AWAY.

NEVER ATTEMPT TO TOUCH OR SERVICE FAN UNIT UNLESS THE MACHINE IS DISCONNECTED FROM THE MAIN ELECTRICITY SUPPLY.

Product Information

Typical Egg Capacities	HB175			HB350			HB500			HB700		
	S	H	C	S	H	C	S	H	C	S	H	C
Quail	495	495	396+99*	990	990	792+198*	1386	1386	990+396*	1980	1980	1584+396*
Partridge	280	280	224+56*	560	560	448+112*	784	784	560+224*	1120	1120	896+224*
Pheasant	240	240	192+48*	480	480	384+96*	672	672	480+192*	960	960	768+192*
Chicken / Duck	175	175	140+35*	350	350	280+70*	490	490	350+140*	700	700	560+140*
Turkey / Big Duck	120	120	96+24*	240	240	192+48*	336	336	240+96*	480	480	384+96*
Goose / Peacock	75	75	60+15*	150	150	120+30*	210	210	150+60*	300	300	240+60*

*Setter part + Hatcher part

Power (W)									
Max:	210			285			425		
Average:	75			100			125		
Electric Supply	230V AC 50Hz / 110V AC 60Hz (as ordered)								



Used electrical and electronic equipment should not be mixed with general household waste. For proper disposal and recycling, please take this product(s) to designated collection points where it will be accepted free of charge.

Disposing of this product correctly will help save valuable resources and prevent any potential negative effects on human health and the environment, which could otherwise arise from inappropriate waste handling.

Please contact your local authority for further details of your nearest designated collection point or visit <https://www.epa.gov/>

Recommended Incubation Values

Typical incubation periods and recommended temperature / humidity values for the species are given below. Incubation periods, temperature and humidity values vary by species. Please check manual or ask your vendor for information.

	Incubation Period (Days)	Setting Temperature	Setting Humidity	Hatching Temperature (Last 2-3 Days)	Hatching Humidity (Last 2-3 Days)
Chicken	21	99.8°F (37.7°C)	%RH 50 - 55	99.0°F (37.2°C)	%RH 65 - 70
Turkey	28	99.5°F (37.5°C)	%RH 50 - 55	98.6°F (37.0°C)	%RH 65 - 70
Quail	17	99.8°F (37.7°C)	%RH 50 - 55	99.1°F (37.3°C)	%RH 65 - 70
Partridge	24	99.5°F (37.5°C)	%RH 50 - 55	98.6°F (37.0°C)	%RH 65 - 70
Pheasant	24	99.8°F (37.7°C)	%RH 55 - 60	99.0°F (37.2°C)	%RH 70 - 75
Duck	28	99.5°F (37.5°C)	%RH 55 - 60	98.6°F (37.0°C)	%RH 70 - 75
Goose	30	99.8°F (37.7°C)	%RH 55 - 60	99.0°F (37.2°C)	%RH 75 - 80

- During last 2-3 days of incubation, keep temperature / humidity set values at hatching values even if you have eggs in setting period.
- For Combined (C) Models, always keep temperature at setting temperature value.
- These are general, **suggested** parameters. Further research will be needed if what you are hatching is not listed or for specific breeds.

HB SERIES



hatchingtime

Hatching Time, LLC

P.O. Box 412 Hockessin, DE 19707
Company Direct: (800) 511-1369

support@hatchingtime.com www.hatchingtime.com



cimuka

Cimuka Kulucka Makineleri ve Ekipmanlari Ltd Sti.

1214.Sok. 21/3 Ostim Yenimahalle – ANKARA / TURKEY
+90 (312) 349 55 66 – +90 (312) 348 1111

cimuka@cimuka.com www.cimuka.com