

Multiwall Polycarbonate Technical & Install Guide

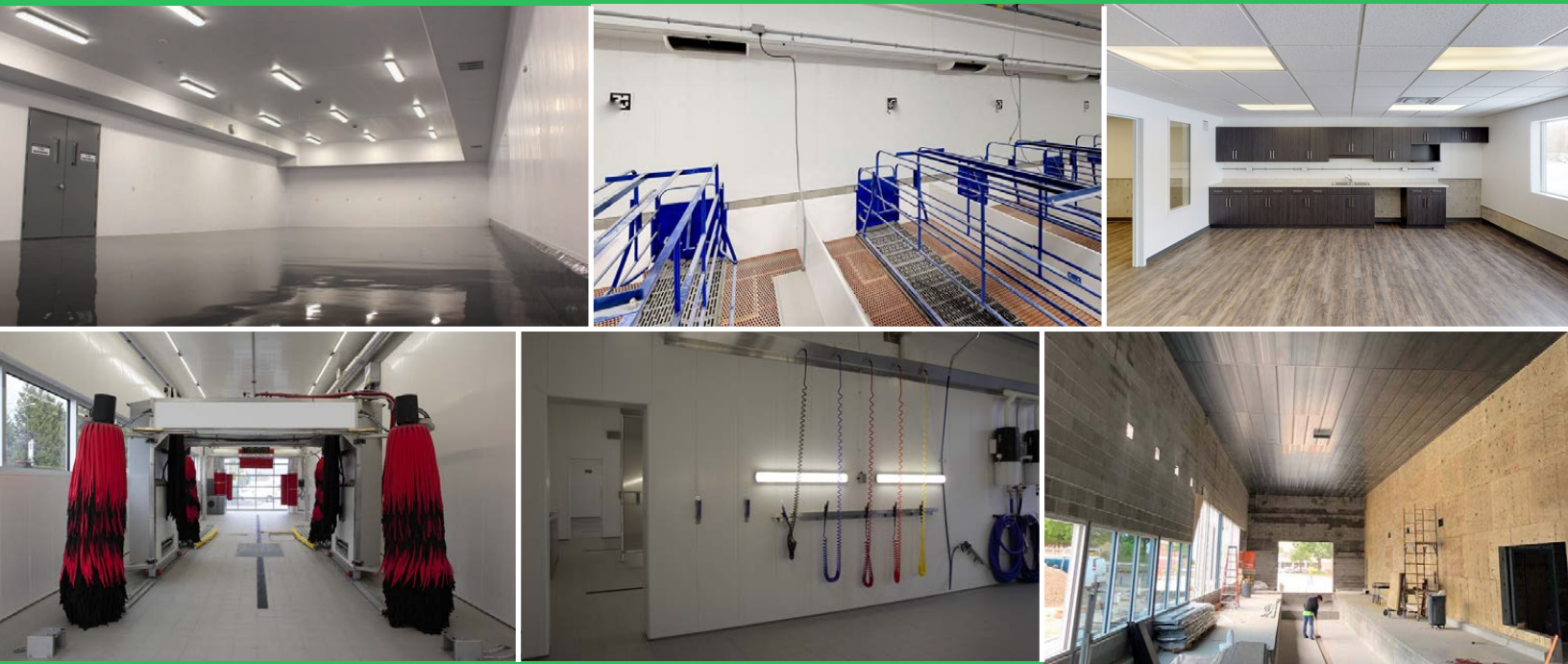

You're the Center of All We Do

 Polymershapes

Table of Contents

| | |
|---|----|
| Introduction | 1 |
| Performance of Multiwall Polycarbonate | 4 |
| UV Protection | 4 |
| Hail Resistance | 4 |
| Physical Properties | 4 |
| Chemical Resistance | 5 |
| Transportation, Handling, and Storage | 6 |
| Transportation | 6 |
| Handling | 6 |
| Storage | 6 |
| Before You Start | 6 |
| Safety Tips | 6 |
| Installation Tools | 7 |
| Install Components | 7 |
| Structural Design Guidelines | 8 |
| Pitch | 8 |
| Rafters | 9 |
| Purlins | 9 |
| Loading | 9 |
| Installation | 16 |
| Protective Film | 16 |
| Cutting | 16 |
| Edge Sealing | 17 |
| Sheet Orientation and Positioning | 18 |
| Cold Bending | 18 |
| Drilling | 19 |
| Fastening | 19 |
| Sealant | 20 |
| Cleaning | 20 |
| Manual Cleaning | 20 |
| Automated Cleaning | 20 |
| Removing 'Stuck-on Product Label' From Sheet | 21 |
| Additional Information | 21 |





About Polymershapes

Polymershapes is the premier distributor of plastic sheet, rod, tube, film, and associated products. We have the industry's most knowledgeable sales team and extensive inventory from world-class supplier partners. We offer expert conversion capabilities including sheet cutting, film conversion and machining. We consistently deliver innovative solutions to delight our customers.

What is Multiwall Polycarbonate?

Polycarbonate (PC) is a thermoplastic polymer that can be extruded into multiwall cellular sheets. These multiwall sheets are extremely strong and lightweight. Polycarbonate offers high light transmittance, making it an ideal alternative to conventional glass products.

Multiwall polycarbonate is easy to use, long lasting, and flexible in a variety of applications. The following technical overview provides basic information on the performance, handling, and installation of multiwall polycarbonate.

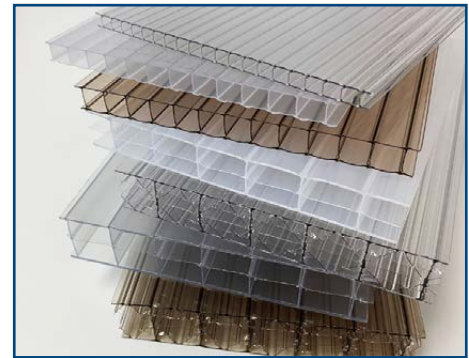

Polycarbonate combines a high level of mechanical, optical, and thermal properties in its structured sheet form:

- ***High Light Transmission***
- ***UV Protection***
- ***Virtually Unbreakable***
- ***Light in Weight***
- ***Thermal Insulation***
- ***Hail and Fire Resistance***
- ***Easily Fabricated On-Site***
- ***Long-Term Weatherability***

Multiwall polycarbonate is manufactured by an extrusion process. Plastic resin is melted and then extruded (pushed through) a die into a wide range of sheet widths, thicknesses, and structural strengths.

Multiwall polycarbonate is an ideal alternative to traditional glass for a wide range of applications, including greenhouses, pool enclosures, skylights, canopies, sunrooms, gazebos, pavilions, deck and patio covers, carports, walkways, wall partitions, and vertical glazing.

Performance of Multiwall Polycarbonate

UV-Protection

The light and radiant energy from the sun has a harmful effect on polycarbonate. Multiwall polycarbonate features a UV-protected surface on one or both sides of the sheet. This UV protection prevents ultraviolet rays from deteriorating the polycarbonate, ensuring the sheet will not crack, yellow, or weaken from intense sun exposure. **When installing multiwall polycarbonate, it is important to have the UV-protected surface facing up or towards the sun.**

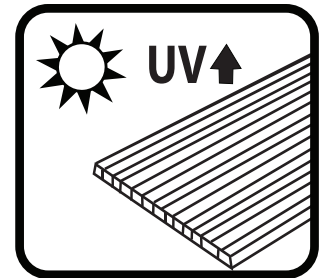

Note: The masking film on the polycarbonate sheet indicates which side of the sheet is UV protected.

Hail Resistance

Multiwall polycarbonate is virtually unbreakable and has outstanding impact strength and performance. In rigorous testing simulating hailstorms with stones of various diameters, multiwall polycarbonate sheets showed no signs of breakage or penetration. Please see product-specific warranty for storm damage coverage.

Physical Properties

Vicat Softening Temperature, B120 ISO 306: 293°. This temperature reflects the point at which polycarbonate will soften in an elevated temperature application.

Continuous-Use Temperature Rating: Maximum of 212°F; Minimum of -40°F. However, it is possible to use multiwall polycarbonate at lower temperatures – the embrittlement temperature (point where the material becomes brittle) is -148°F.

Coefficient of Linear Thermal Expansion, 23-80°C ISO 11359-2: 1°F 4.00 E-05. Because polycarbonate expands and contracts with temperature change, sheets should be installed between 55°F and 70°F. Allowance must be made for both the length and width of a sheet at a rate of .04" per 1' per 100° temperature differentials. Bronze multiwall sheets expand and contract more, requiring an additional 30% space.

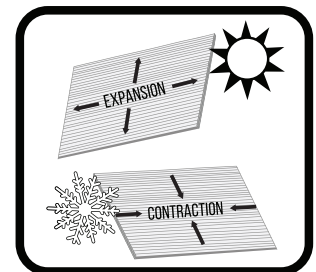

Note: Sheets installed in extreme cold or hot weather conditions (even if the holes are pre-drilled) may crack or warp when the temperature fluctuates between the seasons.

The following chart provides an overview of typical performance values for multiwall polycarbonate sheet products. Actual values may vary depending on specific product color, thickness, or structure.

| PHYSICAL PROPERTIES | | | | | | LIGHT TRANSMISSION | | | | |
|-------------------------------------|---------------------|---------|-----------------------|---------|---------|--------------------|------|--------|----------|-------|
| Product | Thickness mm/ IN | Lbs./sf | Min Bending Radius | R-Value | U-Value | Clear | Opal | Bronze | Softlite | White |
| THERMOCLEAR™ 16mm 3-Wall* | 16mm (5/8") | 0.57 | 110" | 2.50 | 0.40 | 74 | 40 | 30 | 72 | 20 |
| THERMOCLEAR™ 6mm 2-Wall* | 6mm (1/4") | 0.27 | 34" | 1.61 | 0.62 | 82 | 40 | 50 | N/A | 20 |
| VEROLITE™ 6mm 2-Wall** | 6mm (1/4") | 0.27 | 34" | 1.61 | 0.62 | 82 | N/A | N/A | N/A | N/A |
| VEROLITE™ 8mm 2-Wall** | 8mm (5/16") | 0.307 | 55" | 1.75 | 0.57 | 81 | 40 | 30 | 79 | N/A |
| THERMOCLEAR™ 15 8mm 2-Wall** | 8mm (5/16") | 0.348 | 55" | 1.75 | 0.57 | 81 | N/A | N/A | 79 | N/A |
| THERMOCLEAR™ 10mm 2-Wall** | 10mm (3/8") | 0.348 | 69" | 1.92 | 0.52 | 81 | 40 | 50 | N/A | 20 |
| THERMOCLEAR™ 15 16mm 3-Wall** | 16mm (5/8") | 0.57 | 110" | 2.50 | 0.40 | 74 | N/A | N/A | 72 | N/A |
| CoverLite® 4mm Twin Wall** | 4mm (5/32") | 0.164 | 30" | 1.47 | 0.68 | 85 | N/A | N/A | N/A | N/A |
| THERMOCLEAR™ Plus 16mm 5X-Wall** | 16mm (5/8") | 0.57 | 110" | 3.03 | 0.33 | 59 | 52 | N/A | N/A | N/A |
| THERMOCLEAR™ Plus 20mm 5X-Wall** | 20mm (4/5") | 0.66 | 138" | 3.23 | 0.31 | 58 | 50 | 30 | N/A | N/A |
| THERMOCLEAR™ 15 25mm 3-Wall** | 25mm (1") | 0.66 | 173" | 2.94 | 0.34 | 72 | 35 | 35 | N/A | N/A |
| THERMOCLEAR™ Plus 25mm 5X-Wall** | 25mm (1") | 0.70 | 173" | 3.70 | 0.27 | 57 | 49 | 50 | N/A | N/A |

Typical performance values. Actual values may vary depending on specific product.

*items in stock

**special order only

Chemical Resistance

Resistant to some chemicals and non-resistant to others, multiwall polycarbonate sheets are generally unaffected by acids, alcohols, glycols, mineral oil, animal and vegetable fats, kerosene, and non-abrasive cleaners. Check with the manufacturer prior to use or exposure.

Multiwall sheet is affected by benzene, petrol, ketones, acetone, phenols, chlorinated and aromatize hydrocarbons, petroleum-based paints, abrasive cleaners and solvents, acetaldehyde, acetate acid, acetone, acrylonitrile, ammonia, hydrogen sulfide, benzene, benzoate acid, benzoate alcohol, calcium nitrate, bromoxynil, phenol, carbon disulfide, carbon tetrachloride, 5% potassium hydroxide, 5% hydroxide solutions, caustic soda, chlorobenzoate, chloroform, cresol, cyclohexanone, cyclohexene, dimethyl formamide, dioxathion, ethylamine, ethyl ether, 2-ethylene, chlorohydrin, gasoline, methyl methacrylate, nitrobenzene, benzoate methylglyoxal, trichloroacetic acid, xylene, ammonia hydroxide, methylethylketone, dichloromethane, polyvinyl chloride, potassium hydroxide, sodium hydroxide and nitric acid.



Transportation, Handling, and Storage

Transportation

- Use a sturdy pallet (or wooden crate) that is as long as the longest sheet.
- Stack sheets horizontally starting with longest sheet on the bottom (longest to shortest).
- If using a pallet, secure sheets to limit movement during transportation.

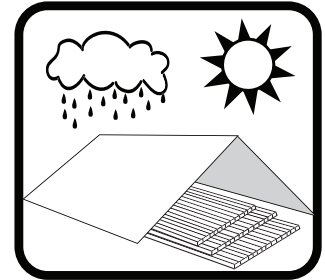

Handling

- Even though polycarbonate is durable, protect sheets when handling.
- Even though polycarbonate is flexible, do not fold sheets when handling.
- To avoid unnecessary scratches, pick up and carry instead of dragging sheets.
- Do not walk, jump, or drive on sheets!

Storage

- Store sheets on a flat, raised surface preferably in a cool, dry place indoors.
- Lay sheets flat and straight, stack shorter sheets on top of longer sheets.
- If kept outdoors, store sheets in a cool and dry place out of direct sunlight.
- Cover sheets with an opaque material that does not absorb or conduct heat.
- Allow for good ventilation to minimize heat and condensation buildup.

Note: *Original crating is not sufficient protection from solar heat gain damage.*

While in transportation and storage, keep sheets out of direct contact with sunlight, cement, PVC, and paint. Cements and paints are extremely incompatible with polycarbonate. Thick wooden boards work well to isolate sheets while transporting or storing.

Before You Start

Safety Tips

For safe installation of sheets, use ladders, protective goggles, and other necessary safety equipment. If you must walk or kneel on sheets during installation, use a sturdy board long enough to span three structural supports. Never walk on installed sheets or leave unfastened sheets unattended.

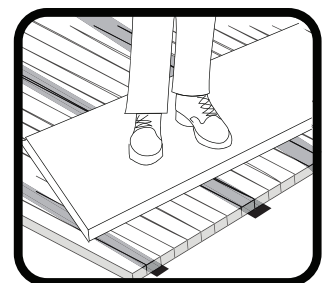

Installation Tools

Lightweight and easy to handle, multiwall sheets can be fabricated on site and require no special tools to install. Common tools needed include: table or circular saw with a fine-tooth blade, clamps, drill with a ¼” bit, tape measure, safety glasses, utility knife, straight edge, sawhorses, and a ladder.

Install Components

Before beginning your project, confirm you have all the necessary install components. Most projects will require one or more of the following:

Fasteners

A key component of most building projects, it is important to make sure you choose the correct fastener for your specific application. When the wrong fastener is used, both the fastener and the sheet can fail.

The chart below is a recommended fastener hardware guide for polycarbonate applications.

| SCREW | LENGTH | TIP/HEAD | MATERIAL THICKNESS | STRUCTURE | WASHER |
|-------|--------|---------------------|--------------------|--------------|--------|
| #10 | 2” | Sharp Tip | 6-16mm | Wood | .75” |
| #10 | 2.5” | Sharp Tip | 25mm | Wood | .75” |
| #12 | 2” | Hex Head | 6-16mm | Treated Wood | .75” |
| #12 | 2.5” | Hex Head | 25mm | Treated Wood | .75” |
| #12 | 1.5” | Self-Drill/Self-Tap | 6-16mm | Steel | .75” |
| #12 | 2” | Self-Drill/Self-Tap | 25mm | Steel | .75” |
| #12 | 1.5” | Self-Drill/Self-Tap | 6-16mm | Aluminum | .75” |
| #12 | 2” | Self-Drill/Self-Tap | 25mm | Aluminum | .75” |

Fasteners should penetrate the structure by at least one (1) inch.

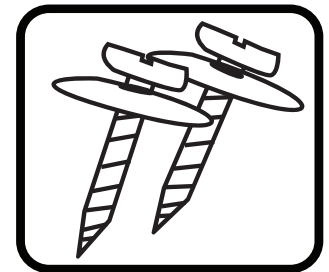

There are many factors to consider when selecting a fastener including length, color, sheet thickness, the type of structure, and the environmental conditions. For help with choosing the right fastener for your project, call 800.421.0102 to speak to a knowledgeable Polymershapes associate.

Tape

Use sealing tape on both ends of a multiwall sheet to prevent dust, bugs, and excess moisture from entering the flutes.

- A solid aluminum foil-coated tape with an all-weather adhesive may be used to seal off the top of a multiwall sheet.
- Vent tape made of a strong non-woven material is recommended to seal off the bottom and/or top of the sheet. Vent tape provides moisture-control and helps to maintain sheet clarity.

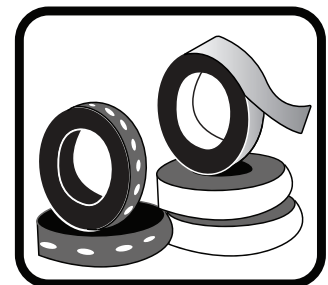

Note: *Tape should not be exposed to the elements; cover it with flashing, ridgecap, or U-Profiles.*

Profiles

- A polycarbonate U-channel may be used to cap off the top and bottom of a multiwall sheet, preventing debris from accumulating within the walls.
- Drill weep holes every twelve (12) inches in U-channel to ensure proper moisture drainage.
- A polycarbonate H-channel may be used to join two multiwall sheets together, providing a finished, professional look.
- An aluminum base and cap frame system may also be used. For more product information, call 800.421.0102 to speak to a knowledgeable Polymershapes associate or visit www.baseandcap.com.

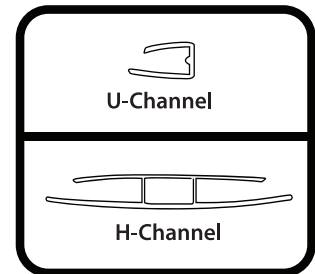

Note: Polycarbonate profiles are not intended as a waterproof solution. It is highly recommended that polycarbonate H-channels be installed vertically or with the slope. Installing H-channels horizontally may result in leaking.

Sealants

After installing profiles, a thin bead of sealant may be used to keep out air, moisture, dirt, and debris but is not typically necessary. The use of a sealant is only recommended for sealing points where the sheet meets an exterior wall.

Note: Only use a 100% silicone sealant. Other types of caulking or sealants may attack the sheet. Always check the product label to ensure sheet compatibility.

If you have any questions concerning the install components required for your project, please contact Polymershapes at 800.421.0102 or send an email to retail@polymershapes.com.

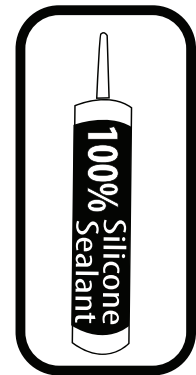

Structural Design Guidelines

Pitch

Before building your structure, you will want to determine the pitch of your roof. The slope or angle of a roof is referred to as the pitch. Beyond aesthetics, the main purpose of a roof's pitch is to shed water, snow, and other debris from the roof.

- The pitch of a roof is calculated by the number of inches it rises vertically for every 12 inches it extends horizontally.
- Snow, wind, and weather loads should always be considered when determining your roof pitch.
- A low roof pitch may require additional sealing to ensure weather resistance.
- To ensure proper drainage of roofing systems, a minimum slope of 2:12 is recommended.

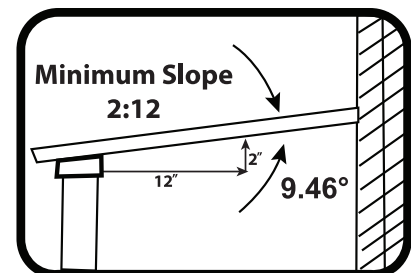

Rafters

Rafters are vertical sloping beams that make up the main framework of a roof. These framing members typically run from the roof peak to the eaves. Rafters support the weight of the roof and the roof load.

- Maximum rafter spacing depends on sheet thickness and sheet width.
- 'On center' is the measurement from the center of one rafter to the center of the next.
- Always check with local building codes first to determine span and on-center spacing for your specific loading conditions.

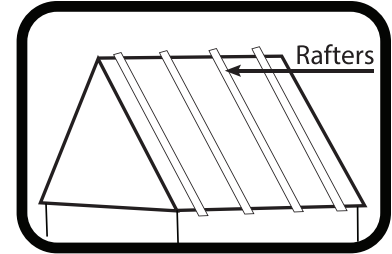

Note: Blocking may be added between rafters depending on rafter span. Check with local building codes for lateral load paths for roof systems.

Purlins

Purlins are horizontal framing members that span over rafters, providing additional structural support for the roof. Purlins aid in supporting the weight of the roof deck. They support the roofing material and transfer the load to the structure below. The roof deck is the 'sheeting' that covers the surface of the roof.

- Minimum recommended nominal size for purlins is 2" x 2" (Two-by-two dimensional lumber).
- Always check with code authorities for specific loading requirements and stresses, especially with high snow loads.
- Maximum purlin span depends on sheet thickness and rafter spacing. Always follow local building code guidelines.

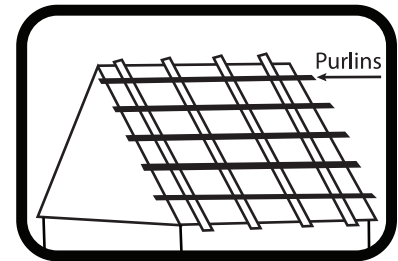

Loading

Loading on polycarbonate sheets is a combination of several factors that are dependent on building type and location. Typically, the biggest factors are snow and wind loads. Design load requirements can be found by standard size charts, local code and code officials, or by an engineer. Loading information provided in this document is generalized and specific requirements must be verified.

- Because of multiwall polycarbonate's exceptional stiffness to weight ratio, it is well suited for load bearing applications such as vertically installed or sloped glazing.

The charts on the following pages provide information to assist in selecting the proper gauge.

- The guidelines are organized in fixed widths of 24", 36", 48", 72", and 83" (rafter spacing).
- Ribes are running perpendicular to the width.
- The data is organized according to allowable deflection limits.
- Select the maximum design deflection and choose the graph with the proper width dimension.
- Then plot, starting from the specified design load (PSF) across the Y axis to the maximum deflection desired.
- The recommended maximum unsupported sheet length is located at the intersection.

Note: A max 1" DMX (deflection) is recommended for polycarbonate H-profiles.

See loading guideline example on next page.

For example: If your material is an 8mm LEXAN™ THERMOCLEAR™ 15 multiwall with 48" rafters, we recommend spacing your purlins at the maximum length of 27" apart. See diagram below.

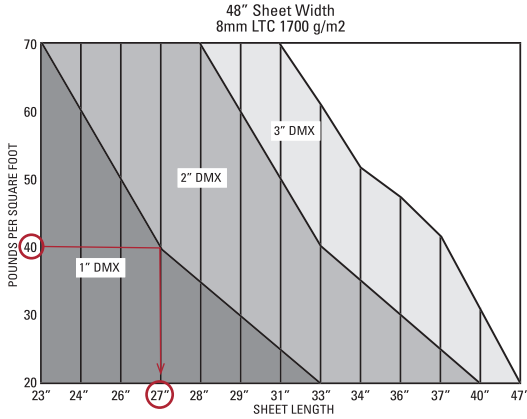

Sheet Width = Rafter Spacing
Sheet Length = Purlin Spacing

Loading Charts

6mm Multiwall Sheet (Stocked)

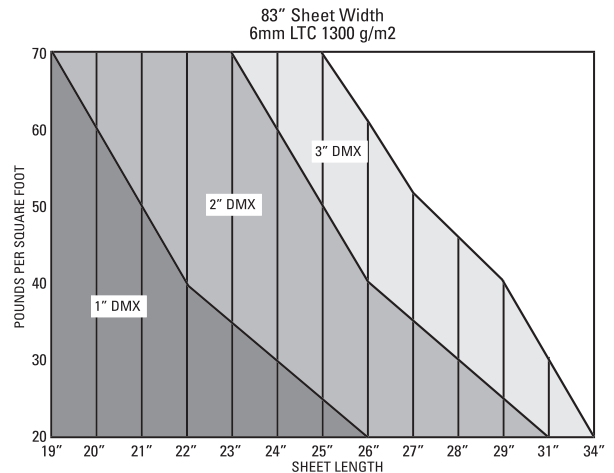
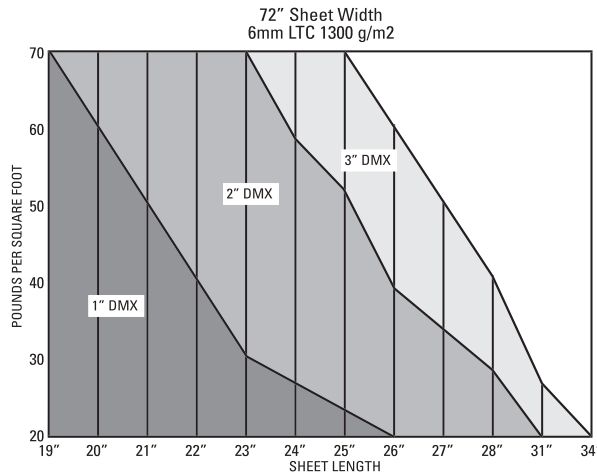
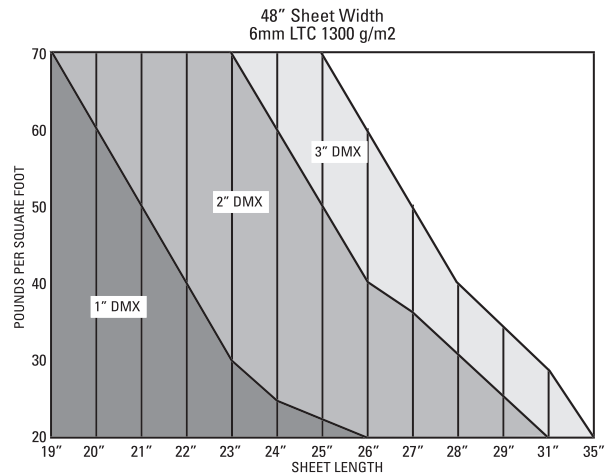
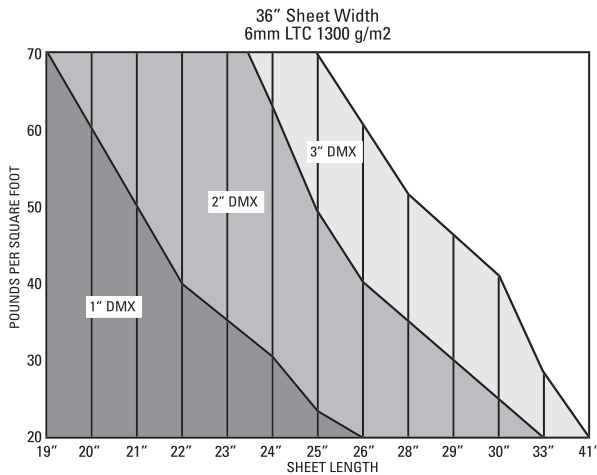
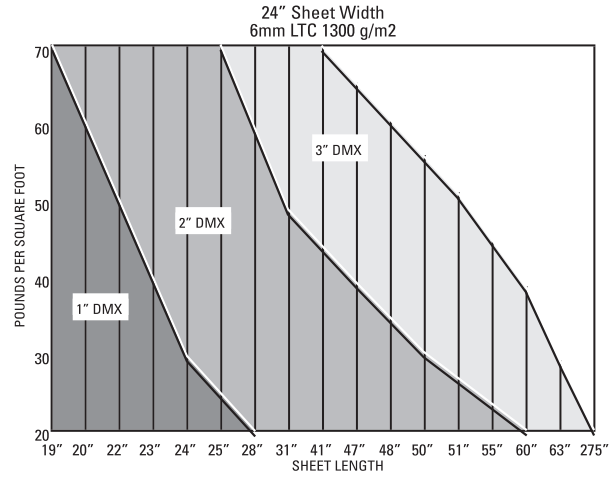

***DMX = Deflection**



8mm Multiwall Sheet (Special Order)

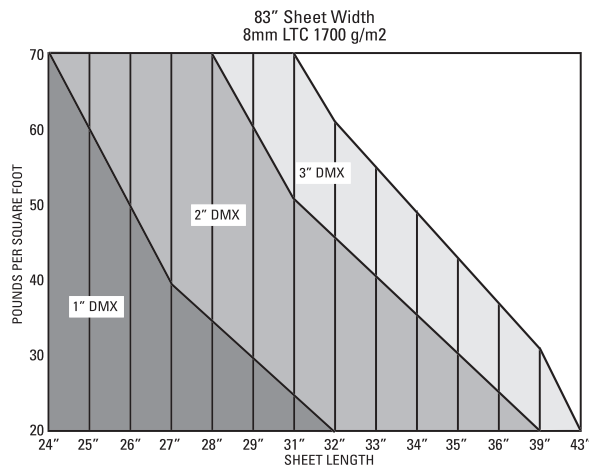
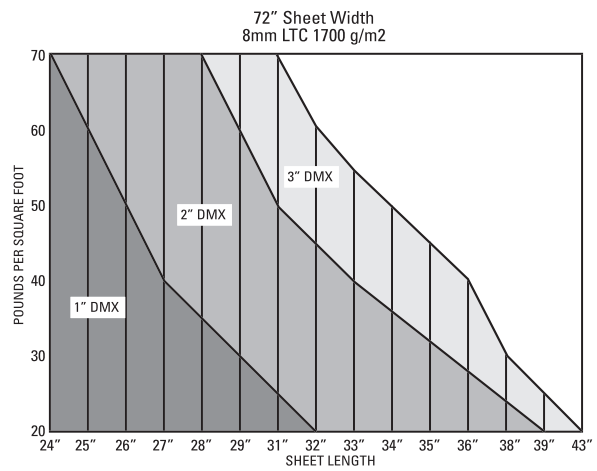
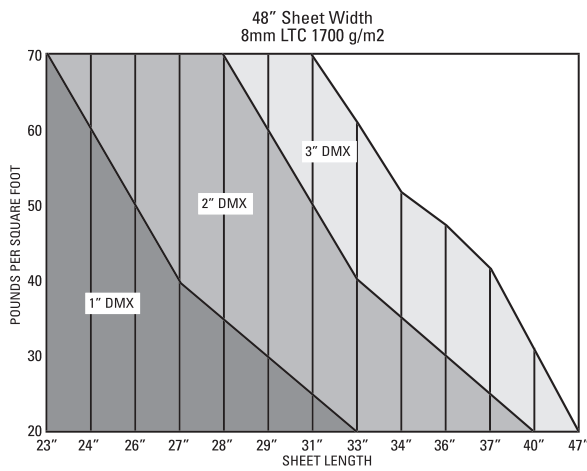
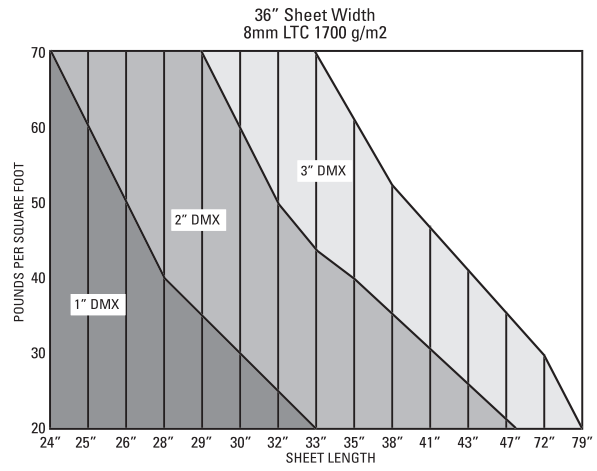
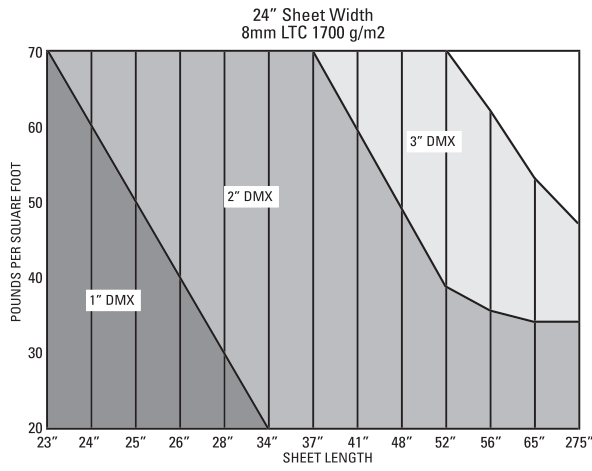

*DMX = Deflection



10mm Multiwall Sheet (Special Order)

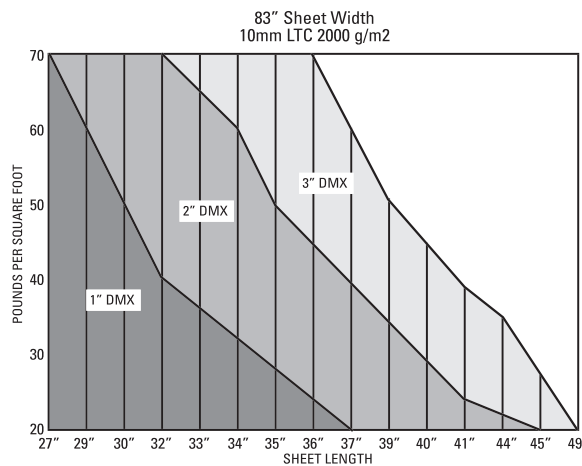
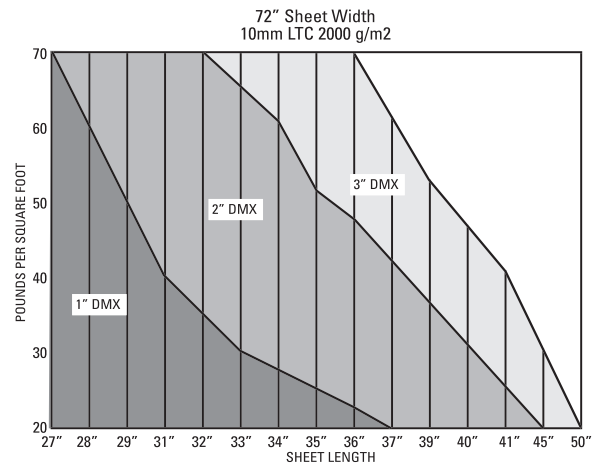
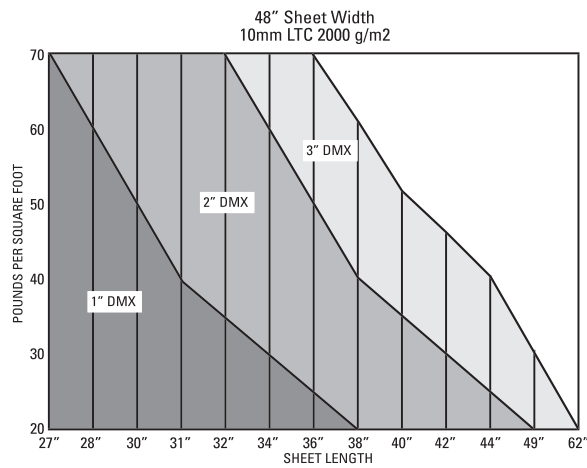
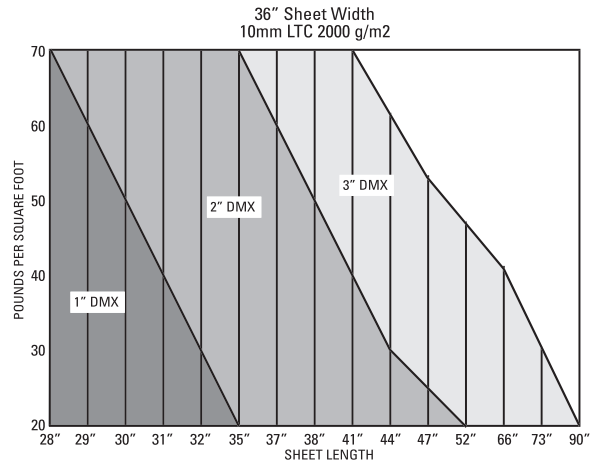
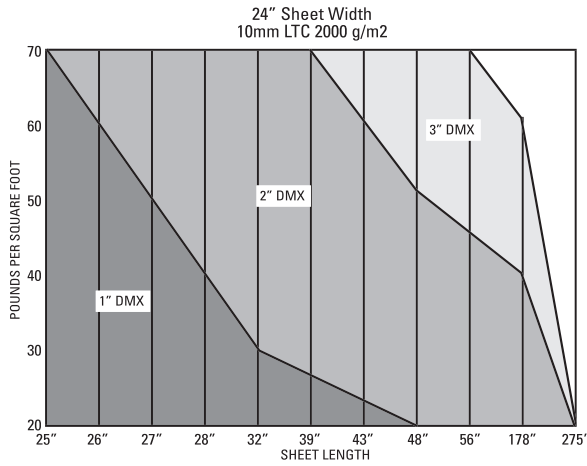

*DMX = Deflection



16mm Multiwall Sheet (Stocked)

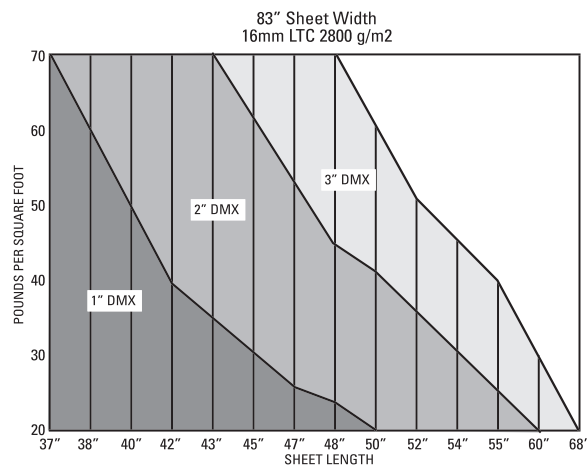
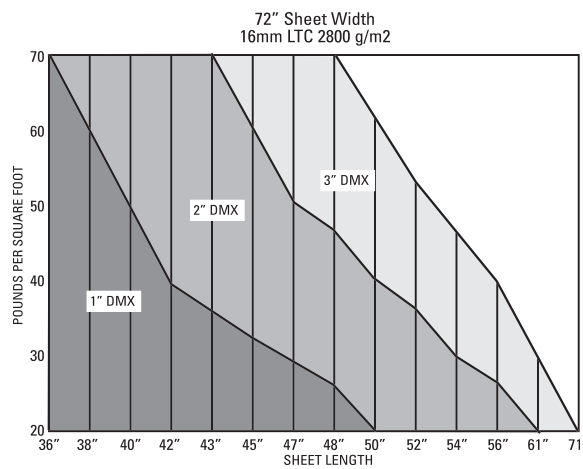
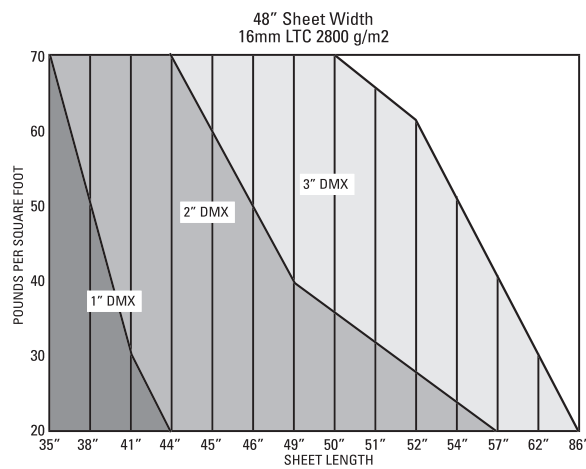
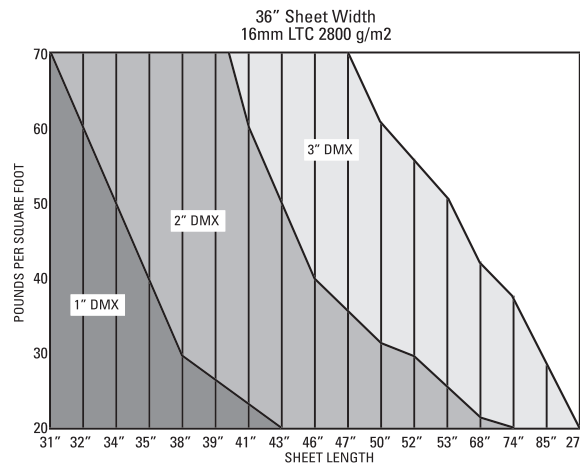
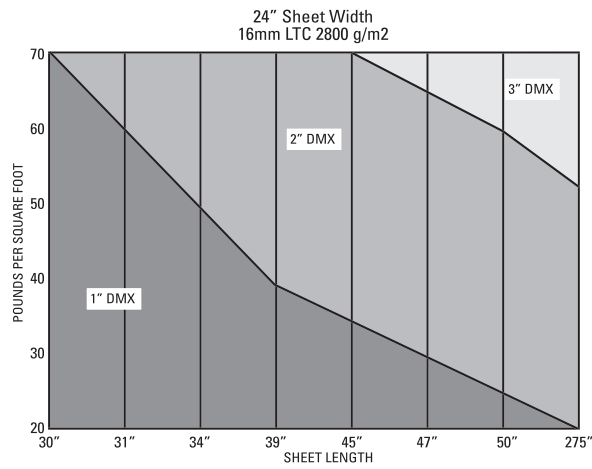

*DMX = Deflection



20mm Multiwall Sheet (Special Order)

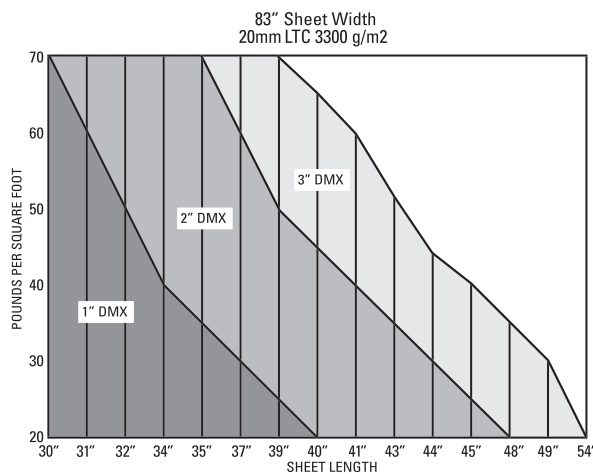
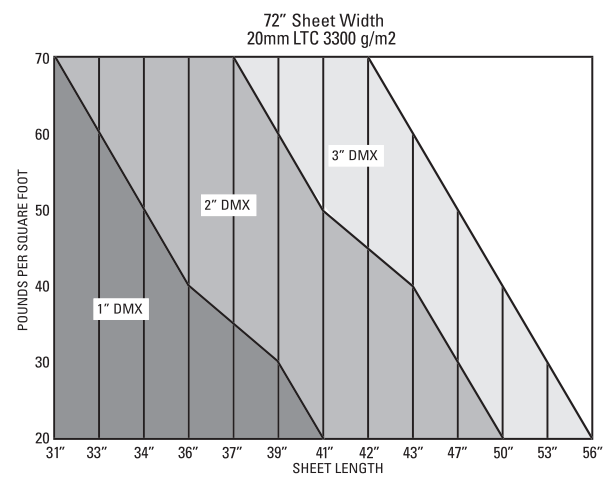
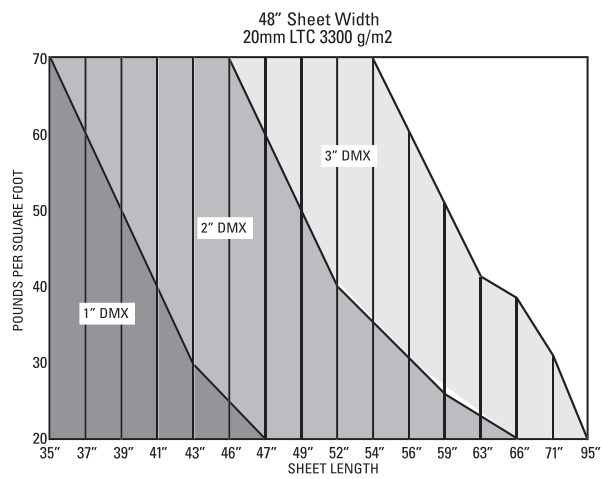
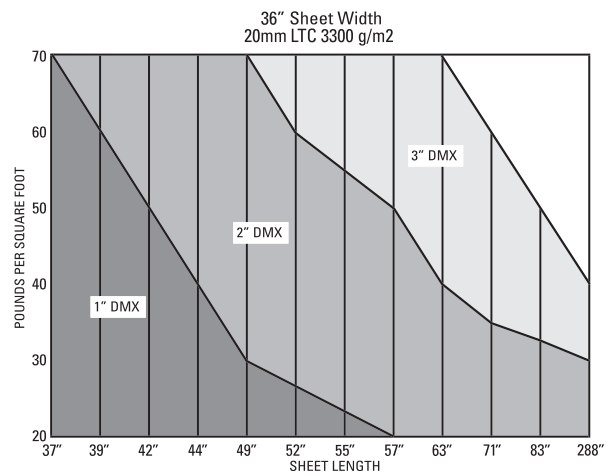
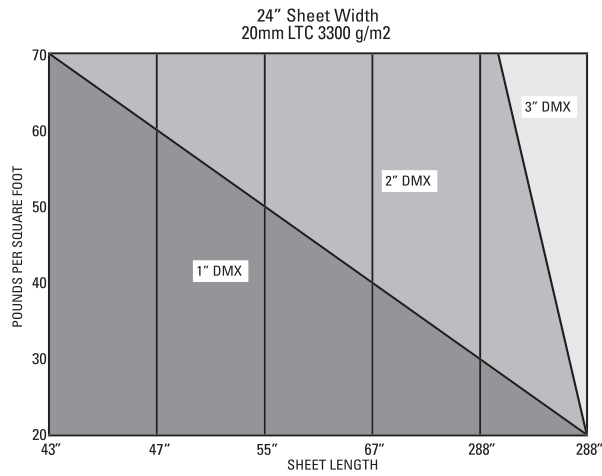

*DMX = Deflection



25mm Multiwall Sheet (Special Order)

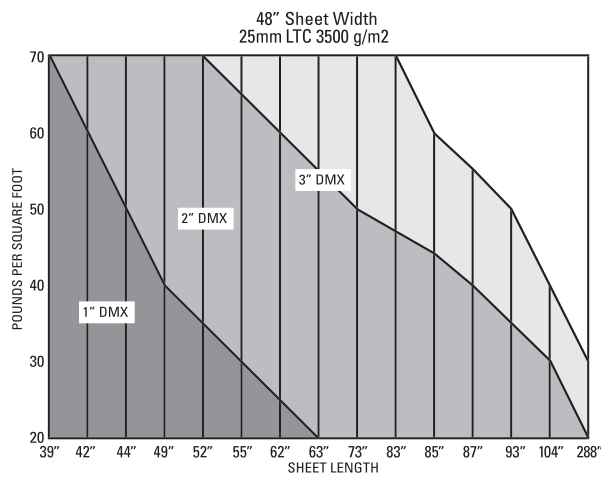
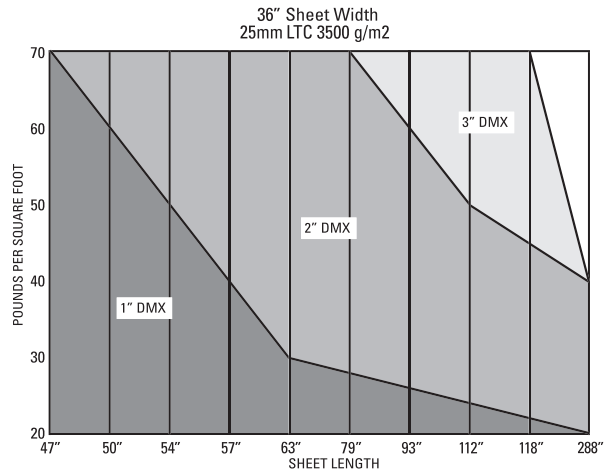
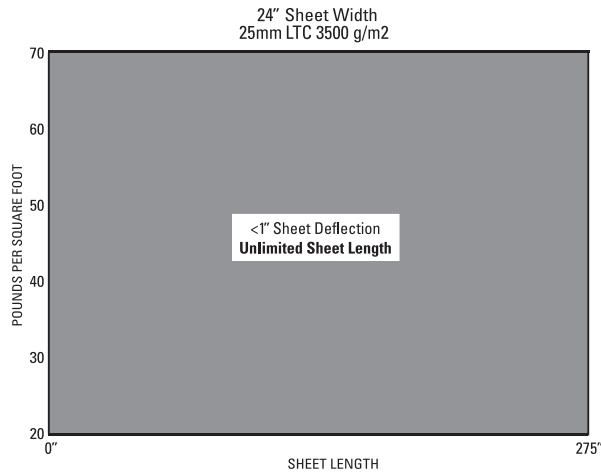

If you have questions concerning the loading guidelines required for your project, please contact Polymershapes at 800.421.0102 or send an email to retail@polymershapes.com.

If you have specific questions about requirements in your region, contact your local code office or building inspector.

*DMX = Deflection



Installation

Protective Film

Multiwall sheets come with a protective film. This film protects the sheets from scratches and provides important product information. **Keep the film on until the sheets are fully installed.**

If needed for cutting, taping, and/or fastening, remove approximately two (2) inches of film from the top and bottom edges of the sheet. The film in the center of the sheet should remain attached while installing the sheet. Remove the remaining film after the installation of the sheet is complete.

Note: *If the masking is stuck to the sheet, rub with a soft cloth wetted with Fels-Naptha or isopropyl alcohol. Pull off the film and follow immediately with a mild soap cleaning and a thorough water rinse. Do not use sharp objects or other chemicals to remove masking.*

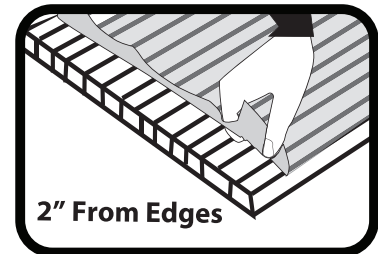

Cutting

Multiwall sheets can easily be cut with common power or manual tools depending on the length of the cut, the width of the panel, and the type of cut. Generally, a saw blade with more teeth creates a smoother cut but does run hotter. To avoid melting the plastic, cut at a high speed but a low advance rate. A fine-tooth blade with at least 10 teeth per inch is recommended for a smooth cut. A plywood blade is a good choice.

Note: *Before cutting the sheet to size, make sure to allow for thermal expansion (movement of both the length and width of the sheet to prevent bowing, warping or distortion).*

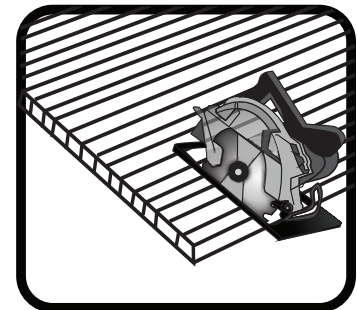

Utility Knife

A utility knife with a sharp blade may be used for short cuts on sheets up to 10mm thick. Always cut away from the body, using a straight edge to guide the knife. With thicker gauges, more than one pass may be needed to cut through the sheet.

Saber Saw

A saber saw with a fine-tooth blade may be used to cut sheets up to 10mm thick. Before cutting, clamp the sheet to the work surface to avoid vibration. It is advisable to use a straight edge to guide the saw blade.

Note: *A saber saw also works well for cutting holes or to round corners. When making pointed turns in the direction of the cut, first drill a hole where the two cuts are to intersect, and then cut through the hole.*

Circular or Table Saw

A circular saw or table saw with a fine-tooth blade may be used to cut any sheet thickness. Before cutting, secure the sheet to the work surface with a clamp and mark a straight line. If needed, pause between cuts to allow the blade to cool. Too much heat may melt the sheet.

Note: Before installing, remove dust or debris from sheet surface with compressed air or a vacuum.

Edge Sealing

The ends of the sheet must be covered to prevent dust, debris, bugs, and excess moisture from entering the flutes. This can be done using sealing tapes and U-profiles. The sheet's flutes (ribs or channels) should be blown free of dust and debris before sealing.

Taping

- Before taping, ensure all of the sheet's edges are smooth and rounded. The sheet should be free of any sharp points.
- On the top or high-end of the sheet, use aluminum (solid) tape to seal off edge. This tape will help prevent moisture and debris from entering the flutes.
- On the lower or bottom edge, use high-quality vent tape to seal off the edge. Vent tape not only prevents debris from entering the flutes but allow the flutes to breathe. This air movement allows any moisture to 'vent' out of the flutes.
- Moisture condenses in the channels of the multiwall panels due to differences in exterior and interior temperature.
- Tape should be applied the long way, covering the open edges of the sheets. The extra width of the tape should be wrapped onto the faces of the sheets.

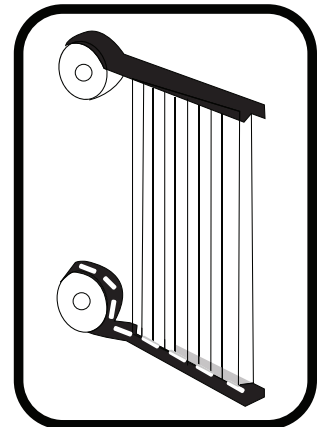

Note: Before applying tape, remove a couple of inches of protective film from the edges of the sheet and blow flutes free of dust.

U-Profiles

In addition to taping the ends of the sheet, the bottom edge should be enclosed with a polycarbonate U-Profile.

- Drill 1/8" weep holes every 12" in the U-profile to facilitate proper condensation drainage.
- The 'longer leg' of the profile should be installed on the inside of the sheet, facing the interior of the structure.
- If using an aluminum frame system, please follow manufacturer recommended guidelines.

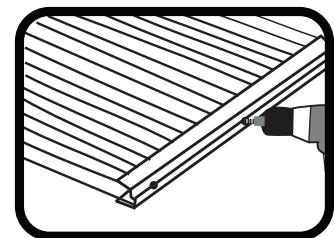

Note: Do not use PVC profiles with multiwall sheets. PVC is highly incompatible with polycarbonate.

Sheet Orientation and Positioning

Install multiwall sheets with the UV-protected side up or facing the sun. On sheets with only one UV-protected side, the protective film indicates which side is protected.

- Install sheets with the flutes (ribs or channels) running vertical (downward) to allow for proper drainage.
- Use an H-Channel to join two multiwall sheets together. This gives a finished, professional look. The 'longer leg' of the profile should be installed on the inside of the sheet, facing the interior of the structure.
- Make sure the UV-protected side of the sheet faces upward or towards the sun.

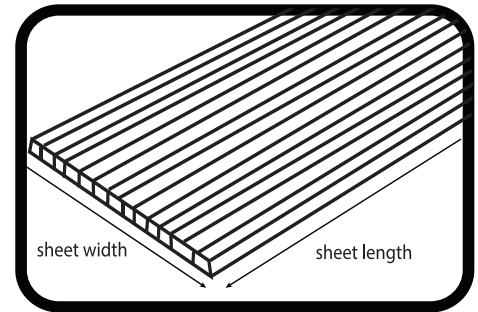

Cold Bending

When cold-bending multiwall polycarbonate, the flutes (ribs or channels) should follow the curve of the sheet. Sheets can be bent in a variety of diameters. Maximum bending radius is in accordance with sheet thickness.

- Bend sheet longitudinally, never across sheet width.
- Bending the sheet lengthwise maintains its sheet strength and ensures proper drainage.
- Avoid over tensing the sheet. Do not flex or install sheets to the point of buckling.

| PRODUCT | THICKNESS MM (INCHES) | MINIMUM BENDING RADIUS |
|------------------|-----------------------|------------------------|
| 4mm Twin wall | 4mm (5/32) | 30" |
| 6mm Twin wall | 6mm (1/4") | 34" |
| 8mm Twin wall | 8mm (5/16") | 55" |
| 10mm Twin wall | 10mm(3/8") | 69" |
| 16mm Triple wall | 16mm (5/8") | 110" |
| 16mm Five wall | 16mm (5/8") | 110" |
| 20mm Five wall | 20mm | 138" |
| 25mm Triplewall | 25mm | 173" |
| 25mm 5x wall | 25mm (1") | 173" |

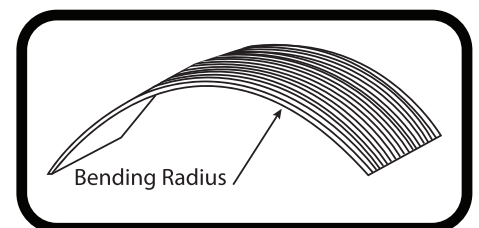

Drilling

Temperature change causes sheets to expand and contract. Any resistance can cause sheet distortion. Always pre-drill holes to allow for thermal movement, providing enough space for seasonal temperature fluctuation.

- Use only new or sharply ground steel or carbide tipped drill bits.
- Drill at a low speed. Support sheet underneath to avoid vibration.
- Pre-drill holes 1/16" larger than the screw's diameter.
- Do not drill within 1-1.5 inches from the edge of the multiwall sheet.

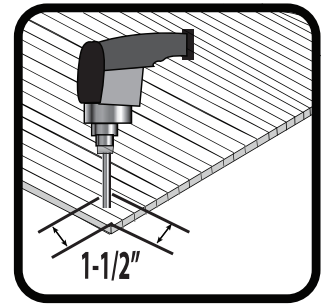

Note: Before fastening, remove dust or debris from sheet surface with compressed air or a vacuum.

Fastening

Attach sheets to the purlins using fasteners recommended for your specific application. For proper point fastening, at least a 1/2" neoprene bonded washers should be used with screws.

- Forty-eight inch (48") wide sheets should be fastened to supports at all four corners, and at points 6 inches in from the edges of each purlin support.
- Seventy-two inch (72") wide sheets should be fastened in the same way, with an additional screw in the center of each purlin support.
- Drive fasteners perpendicular to the multiwall sheet.
- Do not overtighten screws. Overtightened screws may cause sheet to dimple. A correctly installed fastener will sit flush against the sheet.
- Double check that all fasteners are properly secured.

Note: Fasteners should penetrate the structure by at least one (1) inch. Depending on the structural material being used, a larger washer may be needed. Washers distribute load to a wider area and help protect the surface of the sheet from being damaged.

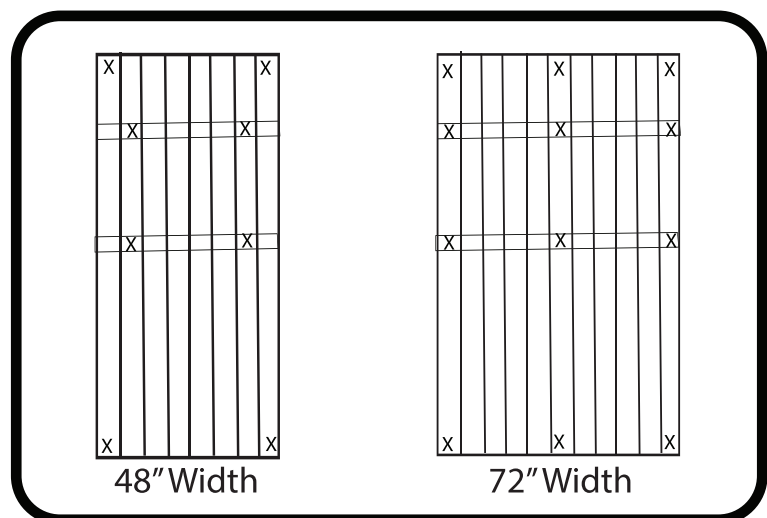

Sealant

After the sheets are installed and the protective masking is removed, points where the sheet meets the building's exterior walls may be sealed with a thin bead of 100% silicone sealant. **Always check the product label to ensure sheet compatibility.**

Note: When using H and U-profiles a continuous bead of sealant is not required between each sheet.

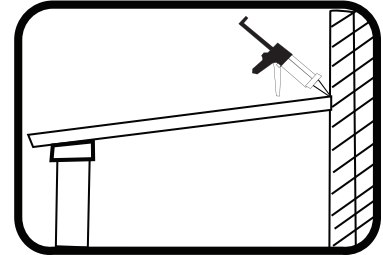

Cleaning

Periodically cleaning in accordance with guidelines can help prolong the life of the sheets. Use of incompatible cleaning products can cause structural and/or surface damage. Normal dust and dirt accumulation is washed off by the rain. Regular rinsing of sheets with clean lukewarm water is sufficient in dry areas.

- Never use abrasive cleaners, corrosive chemicals, or gasoline.
- Never scrub with brushes, steel wool, or other abrasive materials.
- Don't use squeegees, razorblades, or other sharp instruments to remove deposits or spots.
- Don't clean multiwall polycarbonate sheets in direct sunlight or at high temperatures.

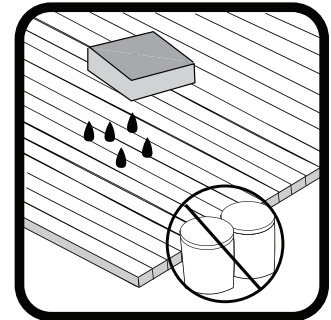

Manual Cleaning – Ideal for Small Areas

- Gently wash sheet with mild household detergent, lukewarm water, and a soft cloth or sponge.
- Thoroughly rinse sheet with clean water and dry with a soft cloth to prevent water spotting.

Automated Cleaning – Ideal for Large Areas

- Use a high-pressure water cleaner (max. 100bar or 1,450psi).
- Always test a small area of the sheet before using a pressure cleaner.
- Use of additives to the water should be avoided.

Note: A good grade of Fels-Naptha or isopropyl alcohol may be used to remove fresh paint or grease. Rub lightly with a soft cloth. Afterwards, wash using mild soap and lukewarm water. Rinse thoroughly.

Removing 'Stuck-on Product Label' From Sheet

- First method: Try saturating the label with soapy lukewarm water to loosen the adhesive. The label should remove easily after about 15 minutes of soaking.
- Second method: Wet a soft cloth with rubbing alcohol (isopropyl alcohol). Place the cloth on the label face. Leave it sit until the rubbing alcohol has soaked through the label (approx. 15 minutes). Starting at one corner, carefully peel off label.

Note: For stubborn labels, spray Goo Gone on the face of the label and let it sit for roughly 15 minutes to completely penetrate the label. Begin at one corner of the label and slowly peel off. If you use Goo Gone, MAKE SURE to clean the area where the label was with soapy lukewarm water and rinse thoroughly to remove any oily residue.

Additional Information

If additional technical, loading, or system information is needed, please contact Polymershapes. If you have a specific question about requirements in your region, contact your local code office or building inspector.

Drawings and technical reports are provided for reference only. Drawings are not project-specific and are for product representation only. Actual products may vary. These drawings are the property of Polymershapes and are to be used solely as a representation of Polymershapes products. These designs may not be recreated or produced without the expressed, written consent of Polymershapes.

All information, recommendations, or advice given by Polymershapes employees or partners, written or oral, is given in good faith and is thought to be accurate and current. It is the responsibility of each product user to ensure the product is used in compliance with current environmental and legal requirements specific to each product application. Polymershapes and its partners will not be held liable for incorrect or improper use of its products.

POLYMERSHAPES HEREBY DISCLAIMS ANY WARRANTIES, EXPRESS OR IMPLIED, INCLUDING IMPLIED WARRANTY OF MERCHANTABILITY AND/OR IMPLIED WARRANTY OF FITNESS FOR A PARTICULAR PURPOSE. POLYMERSHAPES SHALL NOT BE LIABLE FOR ANY INCIDENTAL, CONSEQUENTIAL, OR PUNITIVE DAMAGES.

We are committed to shaping your success!

Polymershapes is the premier distributor of plastic sheet, rod, tube, film, and associated products, with over 75 years of industry-leading heritage. We have the industry's most knowledgeable and highly trained sales and customer service team. Our network of 70+ stocking facilities, located throughout the United States, Canada, Mexico and Chile, enables our customers access to extensive local inventory from world-class supplier partners, and we can provide same-day delivery in many locations.

- Expert conversion capabilities including cut-to-size sheets, film conversion and CNC routing and machining
- Innovative solutions for your material requirements and applications
- An easy, seamless experience – consistent, accurate, with integrity

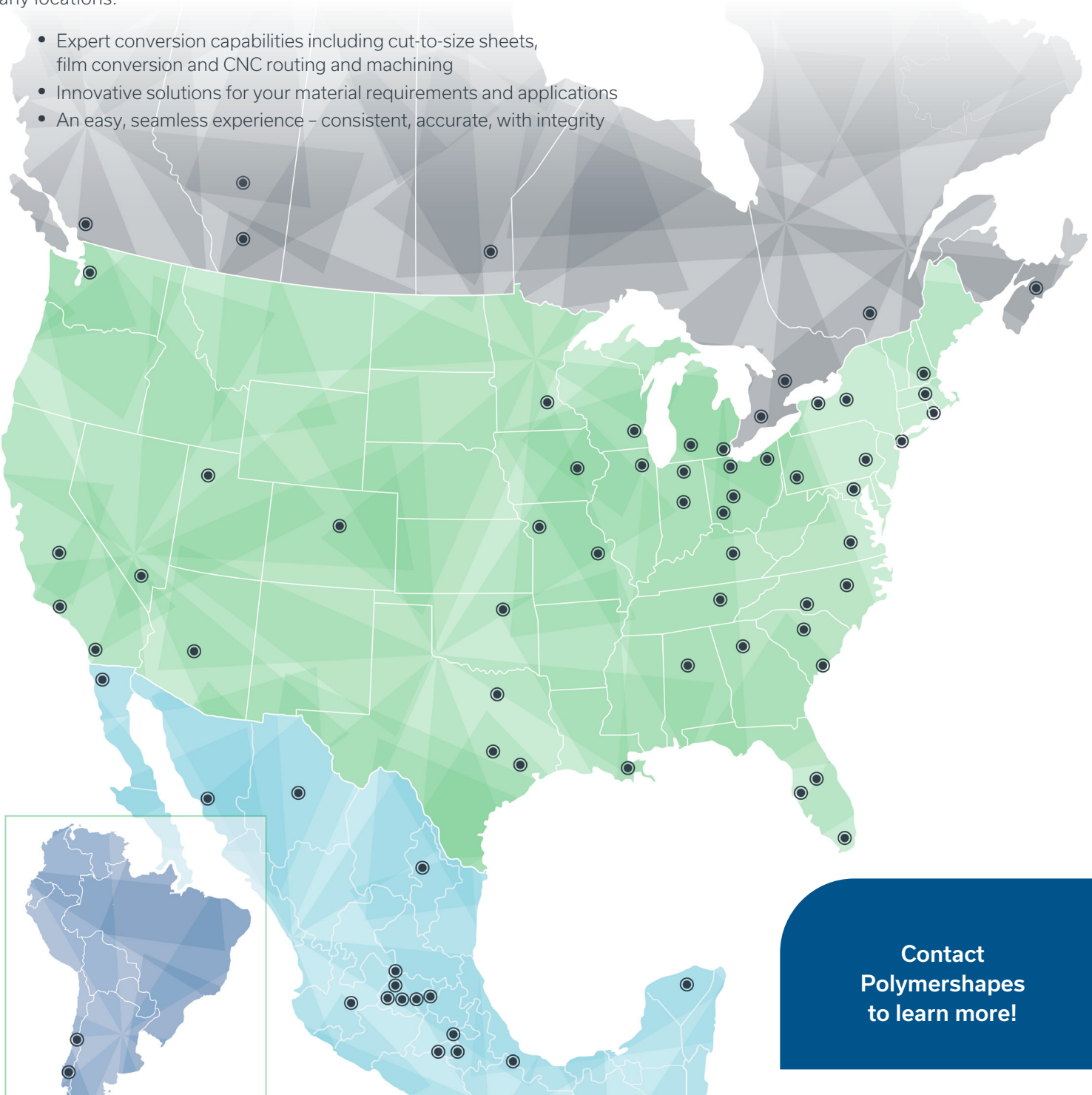

Contact
Polymershapes
to learn more!

Contact us for quotes & availability:
(800) 421-0102 | retail@polymershapes.com

 **Polymershapes**

You're the Center of All We Do
polymershapes.com